

TABLE OF CONTENTS

SECTION		PAGE
1	INTRODUCTION	3
2	THINGS TO KNOW BEFORE STARTING YOUR VEHICLE	9
3	UNDERSTANDING THE FEATURES OF YOUR VEHICLE	117
4	UNDERSTANDING YOUR INSTRUMENT PANEL	215
5	STARTING AND OPERATING	277
6	WHAT TO DO IN EMERGENCIES	343
7	MAINTAINING YOUR VEHICLE	359
8	MAINTENANCE SCHEDULES	415
9	IF YOU NEED CONSUMER ASSISTANCE	439
10	INDEX	447

INTRODUCTION

CONTENTS

■ Introduction	4	■ Vehicle Identification Number	6
■ How To Use This Manual	4	■ Vehicle Modifications / Alterations	7
■ Warnings And Cautions	6		

INTRODUCTION

This manual has been prepared with the assistance of service and engineering specialists to acquaint you with the operation and maintenance of your new vehicle. It is supplemented by a Warranty Information Booklet and various customer oriented documents. You are urged to read these publications carefully. Following the instructions and recommendations in this manual will help assure safe and enjoyable operation of your vehicle.

NOTE: After you read the manual, it should be stored in the vehicle for convenient reference and remain with the vehicle when sold, so that the new owner will be aware of all safety warnings.

When it comes to service, remember that your dealer knows your vehicle best, has the factory-trained technicians and genuine Mopar® parts, and is interested in your satisfaction.

WARNING!







































































Engine exhaust, some of its constituents, and certain vehicle components contain or emit chemicals known to the State of California to cause cancer and birth defects or other reproductive harm. In addition, certain fluids contained in vehicles and certain products of component wear contain or emit chemicals known to the State of California to cause cancer and birth defects or other reproductive harm.

HOW TO USE THIS MANUAL

Consult the table of contents to determine which section contains the information you desire.

The detailed index, at the rear of this manual, contains a complete listing of all subjects.

Consult the following table for a description of the symbols that may be used on your vehicle or throughout this owner's manual:

									
TURN SIGNALS	REAR WINDOW WIPER	WINDSHIELD WIPER INTERMITTENT	BRAKE SYSTEM WARNING PARKING BRAKE	HIGH BEAM	HORN	UPPER AIR OUTLET	HEATED SEAT LOW	DOOR LOCK	ADJUSTABLE PEDALS
									
FUEL	REAR WINDOW INTERMITTENT WIPER	WINDSHIELD WASHER	FAILURE OF ANTI-LOCK BRAKING SYSTEM	LOW BEAM	KEY ACTIVATE (POWER OUTLET)	UPPER AND LOWER AIR OUTLET	HEATED SEAT HIGH	WINDOW LIFT	TIRE PRESSURE MONITOR
									
FUEL FILL SIDE	REAR WINDOW WASHER	WINDSHIELD WASHER FLUID LEVEL	SEAT BELT	FRONT FOG LIGHT	HOOD RELEASE	LOWER AIR OUTLET	RECIRCULATION	CONVERTIBLE 4 WINDOW DOWN	VOICE RECOGNITION BUTTON
									
ENGINE OIL	REAR WINDOW DEFROST	WINDSHIELD, ELECTRICALLY HEATED	AIRBAG	EXTERIOR BULB FAILURE	LIFTGATE RELEASE AND LIFTGATE OPEN	DEFROST AND LOWER AIR OUTLET	VENTILATING FAN	POWER STEERING FLUID	UCONNECT™ BUTTON
									
BATTERY CHARGING	HEATED MIRROR	WINDSHIELD DEFROST	SIDE AIRBAG	DOME LIGHT	SLIDING DOOR	TRUNK / DECK RELEASE	AIR CONDITIONING	SEE OWNER'S MANUAL 150	TRACTION CONTROL
									
ENGINE COOLANT TEMPERATURE	CHILD SEAT TETHER ANCHOR	WINDSHIELD WIPER AND WASHER	HAZARD	PARK LIGHTS	SLOWING DOOR	CONVERTIBLE TOP UP	EMERGENCY RELEASE HANDLE	INSTRUMENT PANEL ILLUMINATION	WARNING
									
MALFUNCTION INDICATOR LIGHT	LOWER ANCHORS AND TETHER FOR CHILDREN (LATCH)	SRS AIRBAG SUPPLEMENTAL RESTRAINT SYSTEM	WINDOW LOCK	LIGHTER	DOOR AJAR	CONVERTIBLE TOP DOWN	PASSENGER AIRBAG OFF	MASTER LIGHTING SWITCH	ESP BAS ELECTRONIC STABILITY PROGRAM / BRAKE ASSIST SYSTEM

WARNINGS AND CAUTIONS

This manual contains **WARNINGS** against operating procedures which could result in an accident or bodily injury. It also contains **CAUTIONS** against procedures which could result in damage to your vehicle. If you do not read this entire manual you may miss important information. Observe all Warnings and Cautions.

VEHICLE IDENTIFICATION NUMBER

Vehicle Identification Number (VIN) is found on the driver's front corner of the instrument panel, visible through the windshield. This number also appears on the vehicle registration or title.

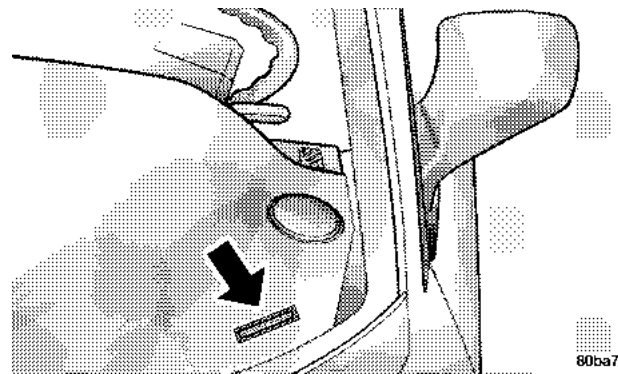

80ba78a8

Vehicle Identification Number

VEHICLE MODIFICATIONS / ALTERATIONS**WARNING!**

Any modifications or alterations to this vehicle could seriously affect its roadworthiness and safety and may lead to an accident resulting in serious injury or death.

THINGS TO KNOW BEFORE STARTING YOUR VEHICLE

CONTENTS

■ A Word About Your Keys13	□ If You Wish To Manually Lock The Steering Wheel18
□ Ignition Key Removal13	□ To Release The Steering Wheel Lock18
□ Locking Doors With The Key14	□ Automatic Transaxle Ignition Interlock System18
□ Key-In-Ignition Reminder15	■ Door Locks18
■ Sentry Key15	□ Manual Door Locks18
□ Replacement Keys16	□ Power Door Locks20
□ Sentry Key Programming17	□ “Child-Protection” Door Lock System (Rear Doors) — If Equipped23
□ General Information17	■ Remote Keyless Entry (Sedan)24
■ Steering Wheel Lock — If Equipped18		

10 THINGS TO KNOW BEFORE STARTING YOUR VEHICLE

□ To Unlock The Doors And Liftgate25	□ Using The Panic Alarm33
□ To Lock The Doors And Liftgate (If Equipped With Power Options)26	□ To Turn Off “Flash Lights With Lock”33
□ Using The Panic Alarm26	□ To Program Additional Transmitters34
□ To Turn Off “Flash Lights With Lock”27	□ General Information35
□ Programming Additional Transmitters27	□ Transmitter Battery Service35
□ General Information29	■ Security Alarm System — If Equipped36
□ Battery Replacement30	□ To Set The Alarm36
■ Remote Keyless Entry (Convertible)31	□ To Disarm The System37
□ To Unlock The Doors31	□ Security System Manual Override37
□ To Lock The Doors32	■ Liftgate (Sedan)38
□ To Unlatch The Deck Lid33	■ Deck Lid (Convertible)39
□ Panic Alarm33	□ Power Deck Lid Release40
		■ Emergency Seat Back Release (Sedan)40

<hr/>		THINGS TO KNOW BEFORE STARTING YOUR VEHICLE	11
■ Emergency Deck Lid Release Latch (Convertible)41	□ Driver And Front Passenger Supplemental Restraint System (SRS) - Airbag55
■ Power Windows42	□ Child Restraint72
□ Auto Down Feature43	■ Occupant Restraints (Convertible)80
□ Rear Window Switches44	□ Lap/Shoulder Belts81
□ Wind Buffeting44	□ Lap/Shoulder Belt Untwisting Procedure86
■ Occupant Restraints (Sedan)44	□ Seat Belt Pretensioners87
□ Lap/Shoulder Belts45	□ Enhanced Seat Belt Reminder System (BeltAlert)88
□ Adjustable Upper Shoulder Belt Anchorage51	□ Seat Belts And Pregnant Women89
□ Lap/Shoulder Belt Untwisting Procedure52	□ Driver And Front Passenger Supplemental Restraint System (SRS) - Airbag89
□ Seat Belt Pretensioners53	□ Child Restraint105
□ Enhanced Seat Belt Reminder System (BeltAlert)54	■ Engine Break-In Recommendations113
□ Seat Belts And Pregnant Women55		

12 THINGS TO KNOW BEFORE STARTING YOUR VEHICLE

- Safety Tips 114
 - Exhaust Gas 114
 - Safety Checks You Should Make Inside The Vehicle 114
- Periodic Safety Checks You Should Make Outside The Vehicle 115

A WORD ABOUT YOUR KEYS

The dealer that sold you your new vehicle has the key code numbers for your vehicle locks. These numbers can be used to order duplicate keys from your dealer. Ask your dealer for these numbers and keep them in a safe place.

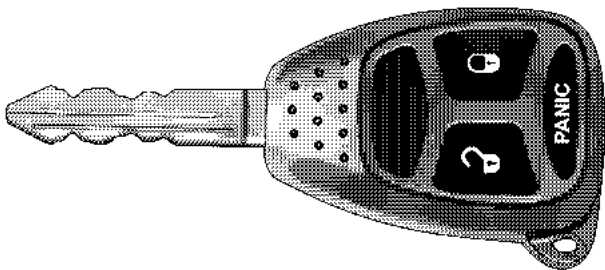

81182d3d

Vehicle Key

Ignition Key Removal

Automatic Transaxle

Place the shift lever in PARK and make sure that the shift knob push button has returned to the out position. Turn the ignition switch to the ACC position, push the key and cylinder inward, rotate the key to the LOCK position, and remove the key.

2

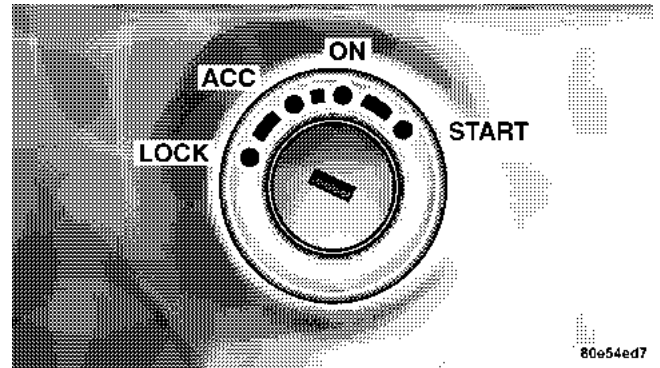

80e54ed7

Ignition Key Position

14 THINGS TO KNOW BEFORE STARTING YOUR VEHICLE

NOTE: If you try to remove the key before you place the lever in PARK, the key may become trapped temporarily in the ignition cylinder. If this occurs, rotate the key to the right slightly, then remove the key as described. If a malfunction occurs, the system will trap the key in the ignition cylinder to warn you that this safety feature is inoperable. The engine can be started and stopped but the key cannot be removed until you obtain service.

WARNING!

Leaving children in a vehicle unattended is dangerous for a number of reasons. A child or others could be injured. Children should be warned not to touch the parking brake, brake pedal or the gear selector lever. Don't leave the keys in the ignition. A child could operate power windows, other controls, or move the vehicle.

CAUTION!

An unlocked car is an invitation to thieves. Always remove key from the ignition and lock all doors when leaving the vehicle unattended.

Manual Transaxle—If Equipped

Turn the ignition switch to the ACC position, push the key and cylinder inward, rotate the key to the LOCK position, and remove the key.

Locking Doors With The Key

You can insert the key with either side up. To lock the door, turn the key rearward, to unlock the door, turn the key forward. See Section 7 of this manual for door lock lubrication.

Key-In-Ignition Reminder

Opening the driver's door when the key is in the ignition, sounds a signal to remind you to remove the key.

NOTE: With the driver's door open, and the key in the ignition, both the power door locks and Remote Keyless Entry (RKE) will not function.

SENTRY KEY

The Sentry Key Immobilizer System prevents unauthorized operation of the vehicle by disabling the engine. The system will shut the engine off after 2 seconds of running if an invalid key is used to start the vehicle. This system utilizes ignition keys which have an electronic chip (transponder) embedded into them. Only keys that have been programmed to the vehicle can be used to start and operate the vehicle.

The Sentry Key Immobilizer System does not need to be armed or activated. Operation of the system is automatic regardless of whether or not the vehicle is locked or

unlocked. During normal operation, the Theft Alarm/Immobilizer Light will come on for three (3) seconds immediately after the ignition switch is turned on for a bulb check. Afterwards, if the bulb remains on, this indicates a problem with the electronics.

If the bulb begins to flash after the bulb check, this indicates that an invalid key has been used to start the vehicle. Both of these conditions will result in the engine being shut off after two (2) seconds of running.

Keep in mind that a key which has not been programmed is also considered an invalid key even if it is cut to fit the ignition lock cylinder for that vehicle.

If the Theft Alarm/Immobilizer Light comes on during normal vehicle operation (vehicle has been running for longer than 10 seconds), a fault has been detected in the electronics and the vehicle should be serviced as soon as possible.

NOTE:

- The Sentry Key Immobilizer System is not compatible with remote starting systems. Use of these systems may result in vehicle starting problems and loss of security protection.
- Exxon/Mobil Speed Pass,TM additional Sentry Keys, or any other transponder equipped components on the same keychain will **not** cause a key-related (transponder) fault unless the additional part is **physically held against the ignition key** being used when starting the vehicle. Cell phones, pagers, or other RF electronics will not cause interference with this system.

All of the keys provided with your new vehicle have been programmed to the vehicle electronics.

Replacement Keys

NOTE: Only keys that have been programmed to the vehicle electronics can be used to start the vehicle. Once a Sentry Key has been programmed to a vehicle, it can not be programmed to any other vehicle.

At the time of purchase, the original owner is provided with a four digit PIN number. This number is required for dealer replacement of keys. Duplication of keys may be performed at an authorized dealer or by using the Customer Key Programming procedure. This procedure consists of programming a blank key to the vehicle electronics. A blank key is one which has never been programmed.

NOTE: When having the Sentry Key Immobilizer System serviced, bring all vehicle keys with you to the dealer.

Sentry Key Programming

You can program new keys to the system if you have two valid sentry keys by performing the following procedure:

1. Cut the additional Sentry Key Transponder blank(s) to match the ignition switch lock cylinder key code.
2. Insert the first valid key into the ignition switch and turn the ignition switch ON for at least 3 seconds but no longer than 15 seconds. Turn the ignition switch OFF and remove the first key.
3. Insert the second valid key and turn the ignition switch ON within 15 seconds. After ten seconds a chime will sound and the Theft Alarm Light will begin to flash. Turn the ignition switch OFF and remove the second key.
4. Insert a blank Sentry Key into the ignition switch and turn the ignition switch ON within 60 seconds. After 10 seconds a single chime will sound. The Theft Alarm Light will stop flashing, turn on for 3 seconds; then turn off.

The new Sentry Key has been programmed.

Repeat this procedure to program up to a total of 8 keys. If you do not have a programmed sentry key, contact your dealer for details.

General Information

The Sentry Key system complies with FCC rules part 15 and with RSS-210 of Industry Canada. Operation is subject to the following conditions:

- This device may not cause harmful interference.
- This device must accept any interference that may be received, including interference that may cause undesired operation.

STEERING WHEEL LOCK — IF EQUIPPED

Your vehicle may be equipped with a passive steering wheel lock. This lock prevents steering the vehicle without the ignition key. If the steering wheel is moved no more than 1/2 turn in either direction and the key is not in the ignition switch, the steering wheel will lock.

If You Wish To Manually Lock The Steering Wheel:

With the engine running, turn the steering wheel upside down, turn off the engine and remove the key. Turn the steering wheel slightly in either direction until the lock engages.

To Release The Steering Wheel Lock:

Insert the key in the ignition switch and start the engine. If the key is difficult to turn, move the wheel slightly to the right or left to disengage the lock.

NOTE: If you turned the wheel to the right to engage the lock, you must turn the wheel slightly to the right to disengage it. If you turned the wheel to the left to engage the lock, turn the wheel slightly to the left to disengage it.

Automatic Transaxle Ignition Interlock System

This system prevents the key from being removed unless the shift lever is in PARK and the shift knob push-button is out. It also prevents shifting out of PARK unless the key is in the ACC, or ON positions, and the brake pedal is depressed.

DOOR LOCKS

Manual Door Locks

Use the manual door lock plunger to lock the doors from inside the vehicle. If the plunger is down when the door is closed, the door will lock. Therefore, make sure the keys are not inside the vehicle before closing the door.

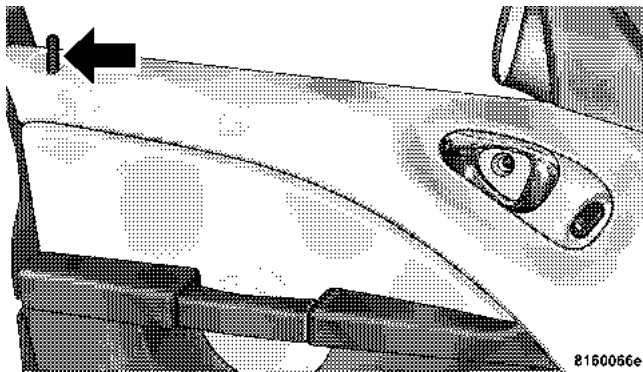

Door Lock Plunger

WARNING!

For personal security, and safety in the event of an accident, lock the vehicle doors as you drive as well as when you park and leave the vehicle.

WARNING!

When leaving the vehicle always remove the key from the ignition lock, and lock your vehicle. Do not leave children unattended in the vehicle, or with access to an unlocked vehicle. Unsupervised use of vehicle equipment may cause severe personal injuries and death.

2

CAUTION!

An unlocked vehicle is an invitation to thieves. Always remove the key from the ignition and lock all of the doors when leaving the vehicle unattended.

Power Door Locks

A door lock switch is on each front door panel. Press this switch to lock or unlock the doors.

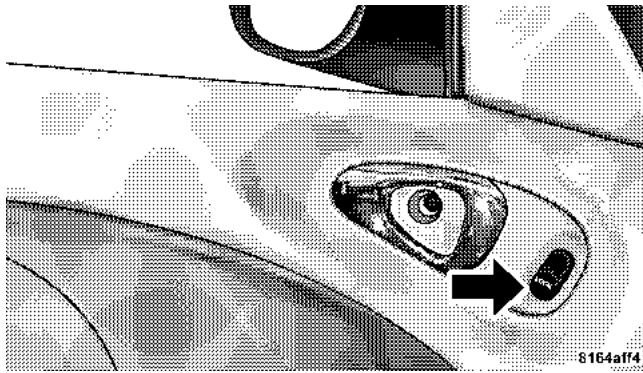

Power Door Lock Switch

Automatic Door Locks—If Equipped

The doors will lock automatically on vehicles with power door locks if all of the following conditions are met:

1. The Auto Lock feature is enabled.
2. The transmission is in gear.
3. All doors are closed.
4. The throttle is pressed.
5. The vehicle speed is above 15 mph (24 km/h).
6. The doors were not previously locked using the power door lock switch or remote keyless entry transmitter.

The Automatic Door Lock feature can be enabled or disabled. Refer to “Personal Settings” (Customer Programmable Features) in the Electronic Vehicle Information Center (EVIC) — if equipped section of this manual for details.

For vehicles not equipped with the EVIC the Automatic Door Locks can be enabled or disabled by performing the following procedure:

1. Close all doors and place the key in the ignition.
2. Cycle the ignition switch between LOCK and ON and back to LOCK 4 times ending up in the LOCK position.

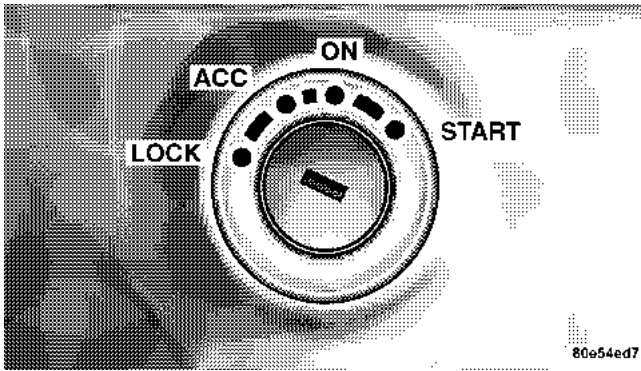

Ignition Key Position

3. Depress the power door lock switch to lock the doors.

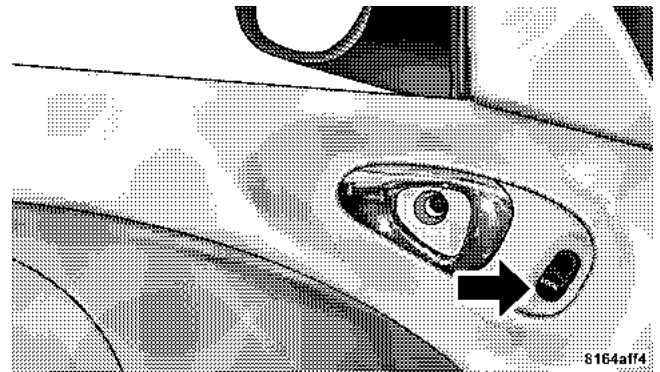

Power Door Lock Switch

4. A single chime will indicate the completion of the programming.

Auto Unlock

The doors will unlock automatically on vehicles with power door locks if:

22 THINGS TO KNOW BEFORE STARTING YOUR VEHICLE

1. The Auto Unlock feature is enabled.
2. The transmission was in gear and the vehicle speed returned to 0 mph (0 km/h).
3. The transmission is in NEUTRAL or PARK.
4. The driver door is opened.
5. The doors were not previously unlocked.
6. The vehicle speed is 0 mph (0 km/h).

The Auto Unlock feature can be enabled or disabled. Refer to “Personal Settings” (Customer Programmable Features) in the Electronic Vehicle Information Center (EVIC) — if equipped section of this manual.

For vehicles not equipped with the EVIC the Auto Unlock Feature can be enabled or disabled by performing the following procedure:

1. Close all doors and place the key in the ignition.

2. Cycle the ignition switch between LOCK and ON and back to LOCK 4 times ending up in the LOCK position.

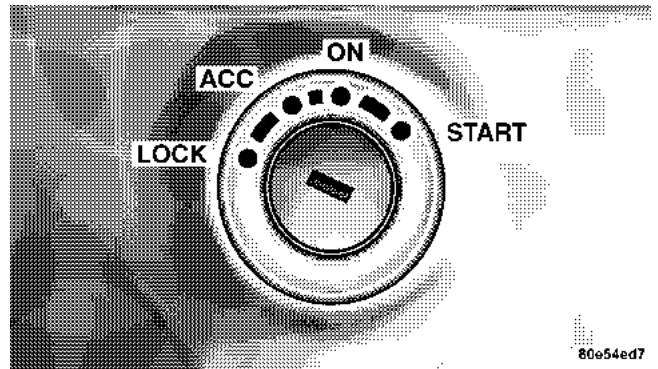

Ignition Key Position

3. Depress the power door unlock switch to unlock the doors.
4. A single chime will indicate the completion of the programming.

NOTE: Use the Auto Door Locks and Auto Unlock features in accordance with local laws.

“Child-Protection” Door Lock System (Rear Doors) — If Equipped

To provide a safer environment for children riding in the rear seat, the rear doors have the “child-protection” door lock system.

To use the system, open each rear door and move the control UP to engage. When the system on a door is engaged, that door can only be opened by using the outside door handle even if the inside door lock is in the unlocked position.

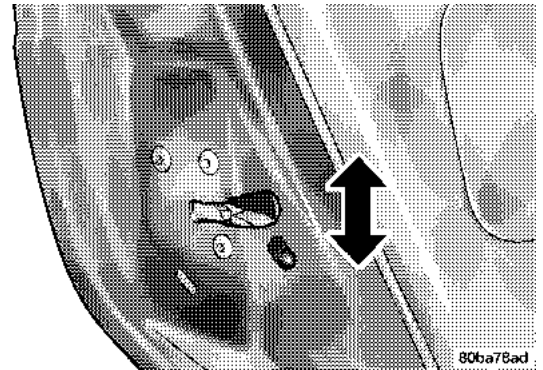

Child Lock Control

WARNING!

Avoid trapping anyone in a vehicle in a collision. Remember that the rear doors can only be opened from the outside when the child protection locks are engaged.

NOTE: For emergency exit with the system engaged, move the lock plunger up (unlocked position), roll down window and open the door with the outside door handle.

REMOTE KEYLESS ENTRY (SEDAN)

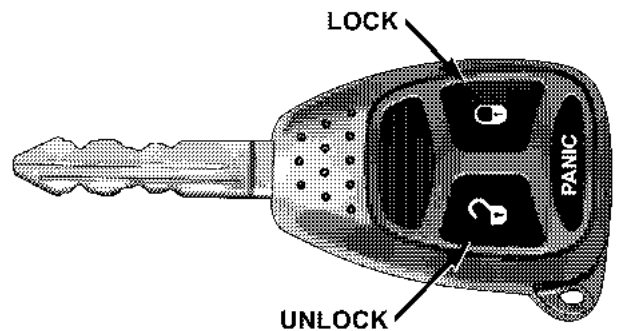

8132a7a6

Three Button Transmitter

This system allows you to lock or unlock the doors and liftgate or activate the panic alarm from distances a minimum of 66 feet (20 meters) using a hand held radio transmitter. The transmitter need not be pointed at the vehicle to activate the system.

NOTE: The line of transmission must not be blocked with metal objects.

To unlock the doors and liftgate:

Press and release the UNLOCK button on the key fob once to unlock only the driver's door or twice to unlock all the doors and liftgate. When the UNLOCK button is pressed, the illuminated entry will initiate, and the parking lights will flash on twice. The time for this feature is programmable on vehicles equipped with the Electronic Vehicle Information Center (EVIC). Refer to "Turn Headlamps on with Remote Key Unlock" under "Personal Settings" in the Electronic Vehicle Information Center (EVIC) section of this manual for details.

NOTE: The system can also be programmed to unlock all doors on the first press of the UNLOCK button. On electronic vehicle information center (EVIC) equipped vehicles refer to "Remote Unlock Driver's Door 1st"

under "Personal Settings" in the EVIC section of this manual. On non EVIC – equipped vehicles perform the following steps:

The system can be programmed to unlock all the doors upon the first UNLOCK button press by using the following procedure:

1. Press and hold the LOCK button on a programmed key fob.
2. Continue to hold the LOCK button at least 4 seconds, but not longer than 10 seconds, then press and hold the UNLOCK button. A single chime will sound to indicate that this feature has changed.
3. Release both buttons at the same time.
4. Test the feature while outside of the vehicle, by pressing the LOCK/UNLOCK button on the keyfob.

NOTE: Pressing the LOCK button on the keyfob while you are inside the vehicle will activate the Security Alarm. Opening a door with the Security Alarm activated will cause the alarm to sound. Press the UNLOCK button to deactivate the Security Alarm.

5. If the desired programming was not achieved or to reactivate this feature, repeat the above steps.

To lock the doors and liftgate (if equipped with power options) :

Press and release the LOCK button on the transmitter to lock all doors. The turn signal lights will flash and the horn will chirp once to acknowledge the lock signal. If desired, the “Sound Horn On Lock” and “Flash Lamps With Lock” feature can be turned on or off. On electronic vehicle information center (EVIC) equipped vehicles refer to “Personal Settings” in the “Electronic Vehicle

Information Center (EVIC)” section of this manual. On non EVIC – equipped vehicles perform the following steps:

1. Press the LOCK button for 4 to 10 seconds.
2. While the LOCK button is pressed (after 4 seconds), press the PANIC button. Release both buttons.

The “Sound Horn On Lock” and “Flash Lamps With Lock” feature can be reactivated by repeating this procedure.

Using The Panic Alarm:

To turn the panic alarm feature ON or OFF, press and hold the PANIC button on the transmitter for at least one second and release. When the panic alarm is on, the headlights and park lights will flash, the horn will pulse on and off and the interior lights will turn on.

The panic alarm will stay on for 3 minutes unless you turn it off by pressing the PANIC button a second time or if the vehicle speed is 5 mph (8 km/h) or greater.

NOTE: When you turn off the panic alarm by pressing the PANIC button a second time, you may have to be closer to the vehicle due to the radio frequency noises of the system.

To Turn Off “Flash Lights With Lock”

NOTE: The Flash Lights With Lock feature can be turned on or off. On Electronic Vehicle Information Center (EVIC) equipped vehicles refer to “Personal Settings” in the EVIC section of this manual. On non EVIC - equipped vehicles perform the following steps:

1. Press the LOCK button for 4 to 10 seconds.
2. While the LOCK button is pressed, (after 4 seconds) press the UNLOCK button. Release both buttons.

3. Test the flash lamps with LOCK feature while outside of the vehicle, by pressing the LOCK button on the key fob with the ignition in the LOCK position, and the key removed.

NOTE: Pressing the LOCK button on the key fob, while you are in the vehicle, will activate the Security Alarm. Opening a door with the Security Alarm activated will cause the alarm to sound. Press the UNLOCK button to deactivate the Security Alarm.

The “Flash Lights On Lock/Unlock” feature can be reactivated by repeating this procedure.

Programming Additional Transmitters

Vehicles will be shipped from the assembly plants with two key fob transmitters programmed only for that vehicle. A total of eight fobs can be programmed for your vehicle. Additional fobs can be programmed to your vehicle through the use of a currently programmed fob.

28 THINGS TO KNOW BEFORE STARTING YOUR VEHICLE

NOTE: When entering program mode using that fob, all other programmed fobs will be erased and you will have to reprogram them for your vehicle.

Use the Following procedure to program additional key fobs if the vehicle is not equipped with Sentry Key:

1. Enter your vehicle and close all doors.
2. Fasten your seat belt (Fastening the seatbelt will cancel any chiming that may confuse you during this programming procedure).
3. Place the key into the ignition.
4. Turn the ignition to the ON position (**Do not start the engine**).
5. Press and hold the UNLOCK button on the key fob.
6. After holding the UNLOCK button for four seconds, also press the PANIC button within 6 seconds.
7. When a single chime is heard release both buttons. The chime is an indication that you have successfully entered program mode. All fobs that are to be programmed must be done so within 60 seconds of when the chime was heard.
8. Using the fob to be programmed, press and release both the LOCK and UNLOCK buttons, simultaneously.
9. A single chime will be heard.
10. Within four seconds of hearing the chime, press and release the UNLOCK button on the fob.
11. A single chime will be heard.
12. Repeat steps 8 through 10 to program up to six additional fobs.
13. Turn the ignition to the OFF position.

14. Your vehicle will remain in program mode up to 60 seconds from when the original chime was heard. After 60 seconds, all programmed fobs function normally.

NOTE: If you do not have a programmed transmitter, contact your dealer for details.

General Information

This device complies with part 15 of FCC rules and with RS-210 of Industry Canada. Operation is subject to the following conditions:

1. This device may not cause harmful interference.
2. This device must accept any interference that may be received including interference that may cause undesired operation.

NOTE: Changes or modifications not expressly approved by the party responsible for compliance could void the user's authority to operate the equipment.

If your Remote Lock Control fails to operate from a normal distance, check for these two conditions.

1. Weak batteries in transmitter. The expected life of batteries is five years.
2. Closeness to a radio transmitter such as a radio station tower, airport transmitter, military base, and some mobile or CB radios.

Battery Replacement

The recommended replacement battery is CR2032.

1. If the key fob is equipped with a screw, remove the screw. With the transmitter buttons facing down, use a flat blade to pry the two halves of the transmitter apart. Make sure not to damage the elastomer seal during removal.

2. Remove and replace the batteries. Avoid touching the new batteries with your fingers. Skin oils may cause battery deterioration. If you touch a battery, clean it with rubbing alcohol.

3. To assemble the transmitter case, snap the two halves together.

NOTE: If the key fob is equipped with a screw, reinstall and tighten the screw until snug.

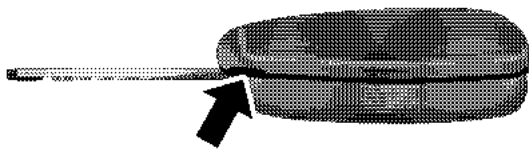

81182c72

Separating Transmitter Halves

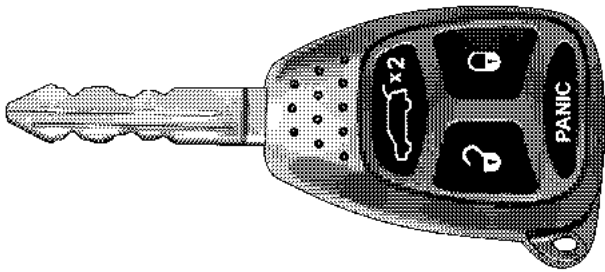
REMOTE KEYLESS ENTRY (CONVERTIBLE)**Four Button Transmitter**

This system allows you to lock or unlock the doors or open the deck lid from distances of 23–50 feet (7–15 meters) using a transmitter. You don't have to point the transmitter at the vehicle to activate the system. Each vehicle comes with two transmitters.

To Unlock the Doors

Press and release the UNLOCK button on the key fob once to unlock only the driver's door or twice to unlock all the doors and liftgate. When the UNLOCK button is pressed, the illuminated entry will initiate, and the parking lights will flash on twice. The time for this feature is programmable on vehicles equipped with the Electronic Vehicle Information Center (EVIC). Refer to "Turn Headlamps on with Remote Key Unlock" under "Personal Settings" in the Electronic Vehicle Information Center (EVIC) section of this manual for details.

NOTE: The system can also be programmed to unlock all doors on the first press of the UNLOCK button. On electronic vehicle information center (EVIC) equipped vehicles refer to "Remote Unlock Driver's Door 1st" under "Personal Settings" in the EVIC section of this manual. On non EVIC – equipped vehicles perform the following steps:

32 THINGS TO KNOW BEFORE STARTING YOUR VEHICLE

The system can be programmed to unlock all the doors upon the first UNLOCK button press by using the following procedure:

1. Press and hold the LOCK button on a programmed key fob.
2. Continue to hold the LOCK button at least 4 seconds, but not longer than 10 seconds, then press and hold the UNLOCK button. A single chime will sound to indicate that this feature has changed.
3. Release both buttons at the same time.
4. Test the feature while outside of the vehicle, by pressing the LOCK/UNLOCK button on the keyfob.

NOTE: Pressing the LOCK button on the keyfob while you are inside the vehicle will activate the Security Alarm. Opening a door with the Security Alarm activated will cause the alarm to sound. Press the UNLOCK button to deactivate the Security Alarm.

5. If the desired programming was not achieved or to reactivate this feature, repeat the above steps.

To lock the doors:

Press and release the LOCK button on the transmitter to lock all doors. The turn signal lights will flash and the horn will chirp once to acknowledge the lock signal. If desired, the "Sound Horn On Lock" and "Flash Lamps With Lock" feature can be turned on or off. On electronic vehicle information center (EVIC) equipped vehicles refer to "Personal Settings" in the "Electronic Vehicle Information Center (EVIC)" section of this manual. On non EVIC – equipped vehicles perform the following steps:

1. Press the LOCK button for 4 to 10 seconds.
2. While the LOCK button is pressed (after 4 seconds), press the PANIC button. Release both buttons.

The “Sound Horn On Lock” and “Flash Lamps With Lock” feature can be reactivated by repeating this procedure.

To Unlatch the Deck Lid

Press the “Rear Release” button twice to unlatch the deck lid.

Panic Alarm

The panic mode flashes the park lights, and sounds the horn for about 3 minutes or until the alarm is turned off.

Using The Panic Alarm:

To turn the panic alarm feature ON or OFF, press and hold the PANIC button on the transmitter for at least one second and release. When the panic alarm is on, the headlights and park lights will flash, the horn will pulse on and off and the interior lights will turn on.

The panic alarm will stay on for 3 minutes unless you turn it off by pressing the PANIC button a second time or if the vehicle speed is 5 mph (8 km/h) or greater.

NOTE: When you turn off the panic alarm by pressing the PANIC button a second time, you may have to be closer to the vehicle due to the radio frequency noises of the system.

To Turn Off “Flash Lights With Lock”

NOTE: The Flash Lights With Lock feature can be turned on or off. On electronic vehicle information center (EVIC) equipped vehicles refer to “Personal Settings” in the EVIC section of this manual. On non EVIC - equipped vehicles perform the following steps:

1. Press the LOCK button for 4 to 10 seconds.
2. While the LOCK button is pressed, (after 4 seconds) press the UNLOCK button. Release both buttons.

34 THINGS TO KNOW BEFORE STARTING YOUR VEHICLE

3. Test the flash lamps with LOCK feature while outside of the vehicle, by pressing the LOCK button on the key fob with the ignition in the LOCK position, and the key removed.

NOTE: Pressing the LOCK button on the key fob, while you are in the vehicle, will activate the Security Alarm. Opening a door with the Security Alarm activated will cause the alarm to sound. Press the UNLOCK button to deactivate the Security Alarm.

The "Flash Lights On Lock/Unlock" feature can be reactivated by repeating this procedure.

To Program Additional Transmitters

NOTE: If vehicle is equipped with the optional Electronic Vehicle Information Center (EVIC) in the instrument cluster, the transmitters may also be programmed through the EVIC display.

Up to 8 transmitters can be programmed to your vehicle. To obtain additional transmitters, contact your authorized

dealer. To program a transmitter (within 23–50 feet (7–15 meters) of the vehicle), perform the following procedure:

1. Gather every transmitter that is to be used with the vehicle including any transmitters that are currently programmed.

2. **Enter Program Mode:** Turn the ignition to the ON position, and using a currently programmed transmitter; press and hold the "Unlock" button on the transmitter. Continue to hold the "Unlock" button, wait at least 4 but no longer than 10 seconds, then press and hold the PANIC button for at least 1 second. Release both buttons simultaneously.

3. **Program Each Transmitter:** All transmitters to be used with your vehicle must be programmed as follows:

Press and release the "Lock" and "Unlock" buttons simultaneously, followed by a press and release of ANY button on each transmitter to be programmed. You will hear a chime when a transmitter has been successfully programmed.

General Information

This transmitter complies with FCC rules part 15 and with RSS-210 of Industry Canada. Operation is subject to the following two conditions:

1. This device may not cause harmful interference.
2. This device must accept any interference that may be received, including interference that may cause undesired operation.

If your Remote Keyless Entry fails to operate from a normal distance, check for these two conditions:

1. Weak batteries in transmitter. The expected life of batteries is from one to two years
2. Closeness to a radio transmitter such as a radio station tower, airport transmitter, and some mobile or CB radios.

Transmitter Battery Service

The recommended replacement battery is the Panasonic CR2032 or equivalent.

1. Pry the transmitter halves apart with a dime or similar object. Make sure not to damage the rubber gasket material during removal.

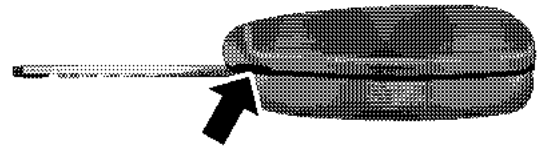
2

81182c72

Separating Transmitter Halves

2. Remove and replace the batteries. Avoid touching the new batteries with your fingers. Skin oils may cause battery deterioration. If you touch the battery, clean it with rubbing alcohol.

3. Reassemble the transmitter case. Snap the halves together and test transmitter operation.

SECURITY ALARM SYSTEM — IF EQUIPPED

The system monitors the doors, liftgate, and ignition switch for unauthorized operation.

If something triggers the alarm, the system will signal for about 18 minutes. For the first 3 minutes the horn will sound and the headlights, park lights, tail lights and the indicator light in the cluster will flash. Then the exterior lights will flash for another 15 minutes.

If the monitored system, which triggered the alarm is deactivated the alarm will continue to sound until 3 minutes of alarm time is reached. If the monitored

system, which triggered the alarm is deactivated after the alarm has been on for 3 minutes the alarm will shut off immediately.

To set the alarm:

1. Remove the keys from the ignition switch and get out of the vehicle.
2. Lock the door using either the door key, power door lock switch, or the Keyless Entry Transmitter and close all doors.
3. The indicator light in the instrument cluster will flash rapidly for 16 seconds. This shows that the system is arming. During this period, if a door is opened, the ignition switch is turned ON, or the power door locks are unlocked in any manner, the system will automatically disarm. After 16 seconds the indicator light will flash slowly. This shows that the system is fully armed.

To disarm the system:

Unlock a front door/liftgate using the Keyless Entry Transmitter.

Starting the vehicle with a valid Sentry key will disarm the system. A valid key is one that is programmed to that particular vehicle. A valid key will disarm the system, an invalid key will trigger the alarm.

Tamper Alert

If the horn sounds 3 times when you unlock a front door using either a key or the Keyless Entry Transmitter, the alarm has been activated. Check the vehicle for tampering.

Security System Manual Override

The system will not arm if you lock the doors using the manual door lock plunger.

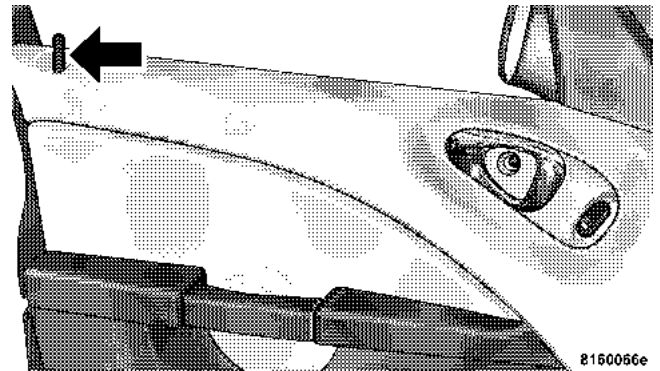

Door Lock Plunger

LIFTGATE (SEDAN)

NOTE: The key that is used to start the vehicle is also used to lock or unlock the doors and open the liftgate (if equipped). Rotate the key and pull the liftgate up.

To unlock the liftgate, insert the key into the lock and turn to the right. If equipped, the liftgate can also be unlocked using the remote keyless entry or by activating the power door lock switches located on the front doors. The central locking/unlocking feature (if equipped) can also be activated from the liftgate key cylinder.

Once unlocked, the liftgate can be opened or closed without using the key. To open the liftgate, squeeze the liftgate release touch pad located on the backside of the liftgate handle and pull the liftgate open with one fluid motion (if equipped).

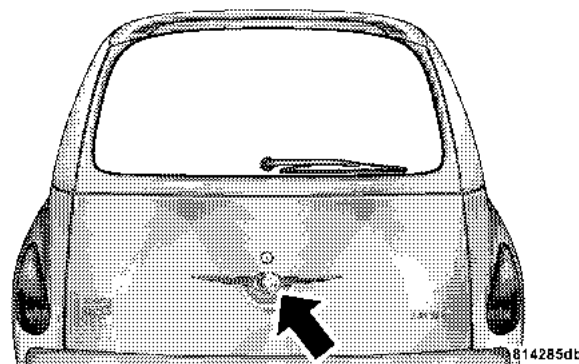

Liftgate Handle

NOTE: In the event of a power malfunction, or the remote transmitter is inoperative, insert the key into the liftgate lock cylinder and turn to the right. Using the liftgate handle, pull the liftgate open with one fluid motion.

WARNING!

- Driving with the liftgate open can allow poisonous exhaust gases into your vehicle. You and your passengers could be injured by these fumes. Keep the liftgate closed when you are operating the vehicle.
- If you are required to drive with the liftgate open, make sure that all windows are closed, and the climate control blower switch is set at high speed. DO NOT use the recirculation mode.

Gas props support the liftgate in the open position. However, because the gas pressure drops with temperature, it may be necessary to assist the props when opening the liftgate in cold weather.

DECK LID (CONVERTIBLE)

NOTE: The key that is used to start the vehicle is also used to lock or unlock the doors and open the deck lid.

To open the deck lid, insert the key into the lock and turn to the right. The deck lid can also be opened using the remote keyless entry or by using the power deck lid release switch located in the glove box.

WARNING!

- Driving with the deck lid open can allow poisonous exhaust gases into your vehicle. You and your passengers could be injured by these fumes. Keep the deck lid closed when you are operating the vehicle.
- If you are required to drive with the deck lid open, make sure that all windows are closed, and the climate control blower switch is set at high speed. DO NOT use the recirculation mode.

Gas props support the deck lid in the open position. However, because the gas pressure drops with temperature, it may be necessary to assist the props when opening the deck lid in cold weather.

Power Deck Lid Release

You can open the deck lid by pressing the Remote Keyless Entry Button or from inside the vehicle, using the switch located inside the glove box. On vehicles equipped with a manual transmission, the power deck lid release switch is disabled if the doors are locked, or if vehicle speed exceeds 0 mph (0 km/h), or when the clutch pedal is depressed. On vehicles equipped with an automatic transmission, the power deck lid release switch is disabled if the doors are locked, or the transmission is out of PARK.

EMERGENCY SEAT BACK RELEASE (SEDAN)

WARNING!

Do not allow children to have access to the liftgate area with the rear shelf panel in position 1 (Top) or position 2 (Middle), either by climbing into the liftgate from outside, or through the inside of the vehicle. Always close the liftgate when your vehicle is unattended. Once in the liftgate area, young children may not be able to escape, even if they entered through the rear seat. If trapped in the liftgate, children can die from suffocation or heat stroke.

As a security measure, a Seat Back Emergency Release lever is built into the left side rear seat back latching mechanism. In the event of an individual being locked inside the liftgate area with the rear shelf panel in position 1 (Top) or position 2 (Middle), the left side rear

seat back can be unlatched by pulling down on the glow-in-the-dark lever attached to the left rear seat back latching mechanism.

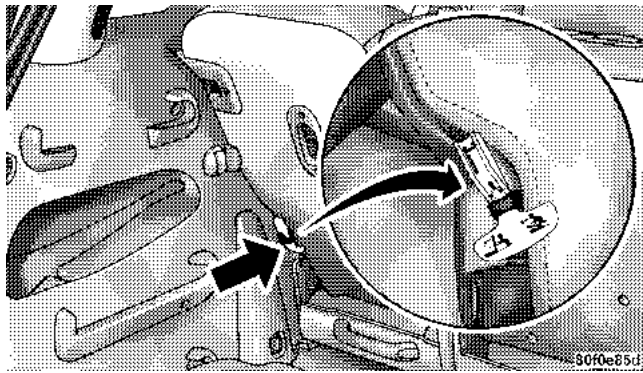

Emergency Seat Back Release

Once unlatched the seat back can be pushed forward to gain access into the interior of the vehicle.

NOTE: Make sure that the elastic loop is around the emergency release handle at all times. If the handle is pulled downward, entirely through the elastic loop, the handle will not return to its original position and the seat back may not operate properly.

2

EMERGENCY DECK LID RELEASE LATCH (CONVERTIBLE)

WARNING!

Do not allow children to have access to the trunk, either by climbing into the trunk from outside, or through the inside of the vehicle. Always close the deck lid when your vehicle is unattended. Once in the trunk, young children may not be able to escape, even if they entered through the rear seat. If trapped in the trunk, children can die from suffocation or heat stroke.

As a security measure, an emergency deck lid release lever is built into the deck lid latching mechanism. In the event of an individual being locked inside the trunk, the trunk can be simply opened by pulling on the glow-in-the-dark lever attached to the deck lid latching mechanism. See following picture.

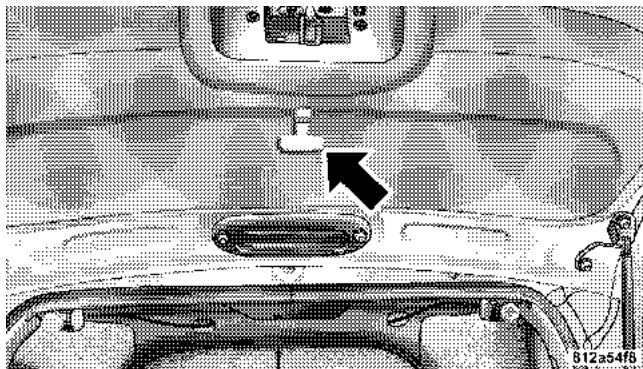

Emergency Deck Lid Release Handle

POWER WINDOWS

The power window switches are located on the instrument panel above the radio. The top left switch controls the left front window and the top right switch controls the right front window.

The lower left switch controls the left rear passenger's window and the lower right switch controls the right rear passenger's window.

The sedan has a window lock switch, located between the window switches allows you to disable the rear window switches that are located at the back of the center floor console.

The convertible has an "All windows up" and "All windows down," switch located between the window switches instead of the lock switch.

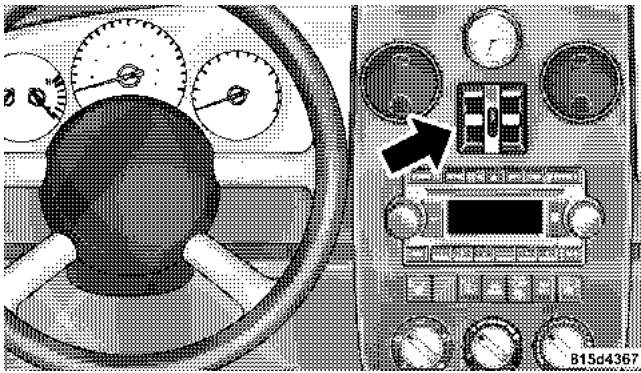

Power Window Switch

WARNING!

Never leave children in a vehicle, with the keys in the ignition switch. Occupants, particularly unattended children, can become entrapped by the windows while operating the power window switches. Such entrapment may result in serious injury or death.

2

Auto Down Feature

The driver's and passenger's front window switches have an auto down feature. Press the window switch past the detent, release, and the window will go down automatically. Press the switch a second time in either direction to stop the window.

To open the window part way, press the window switch part way and release it when you want the window to stop.

Rear Window Switches

There are also rear passenger window switches (sedan only) located at the rear of the center console.

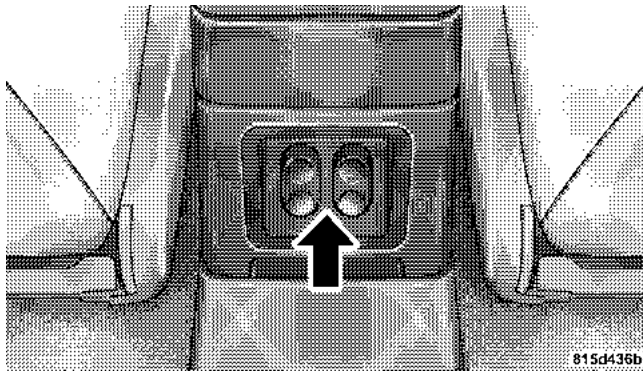

Rear Power Window Switches

Wind Buffeting

Wind buffeting can be described as the perception of pressure on the ears or a helicopter type sound in the ears. Your vehicle may exhibit wind buffeting with the windows down, or the sunroof (if equipped) in certain open or partially open positions. This is a normal occurrence and can be minimized. If the buffeting occurs with the rear windows open, open the front and rear windows together to minimize the buffeting. If the buffeting occurs with the sunroof open, adjust the sunroof opening to minimize the buffeting.

OCCUPANT RESTRAINTS (SEDAN)

Some of the most important safety features in your vehicle are the restraint systems. These include the front and rear seat belts for the driver and all passengers, front airbags for both the driver and front passenger and if equipped, side airbags for both the driver and front passenger. If you will be carrying children too small for

adult-size seat belts, your seat belts or the LATCH feature also, can be used to hold infant and child restraint systems.

Please pay close attention to the information in this section. It tells you how to use your restraint system properly to keep you and your passengers as safe as possible.

WARNING!

In a collision, you and your passengers can suffer much greater injuries if you are not properly buckled up. You can strike the interior of your vehicle or other passengers, or you can be thrown out of the vehicle. Always be sure you and others in your vehicle are buckled up properly.

Buckle up even though you are an excellent driver, even on short trips. Someone on the road may be a poor driver and cause a collision that includes you. This can happen far away from home or on your own street.

Research has shown that seat belts save lives, and they can reduce the seriousness of injuries in a collision. Some of the worst injuries happen when people are thrown from the vehicle. Seat belts reduce the possibility of ejection and the risk of injury caused by striking the inside of the vehicle. **Everyone** in a motor vehicle should be belted at all times.

Lap/Shoulder Belts

If the belt webbing is twisted, and comes in contact with the wearers body, the twisted belt should be corrected using the Lap/Shoulder belt untwisting procedure found in this section.

All the seats in your vehicle are equipped with Lap/Shoulder Belts.

The belt webbing retractor is designed to lock during very sudden stops or collisions. This feature allows the shoulder part of the belt to move freely with you under normal conditions. But in a collision, the belt will lock and reduce the risk of your striking the inside of the vehicle or being thrown out.

WARNING!

- It is extremely dangerous to ride in a cargo area, inside or outside of a vehicle. In a collision, people riding in these areas are more likely to be seriously injured or killed.
- Do not allow people to ride in any area of your vehicle that is not equipped with seats and seat belts.
- Be sure everyone in your vehicle is in a seat and using a seat belt properly.

WARNING!

- Wearing a seat belt incorrectly is dangerous. Seat belts are designed to go around the large bones of your body. These are the strongest parts of your body and can take the forces of a collision the best.
- Wearing your belt in the wrong place could make your injuries in a collision much worse. You might suffer internal injuries, or you could even slide out of part of the belt. Follow these instructions to wear your seat belt safely and to keep your passengers safe, too.
- Two people should never be belted into a single seat belt. People belted together can crash into one another in an accident, hurting one another badly. Never use a lap/shoulder belt or lap belt for more than one person, no matter what their size.

Lap/Shoulder Belt Operating Instructions

1. Enter the vehicle and close the door. Sit back and adjust the seat.
2. The seat belt latch plate is above the back of the front seat, next to your arm. Grasp the latch plate and pull out the belt. Slide the latch plate up the webbing as far as necessary to allow the belt to go around your lap.

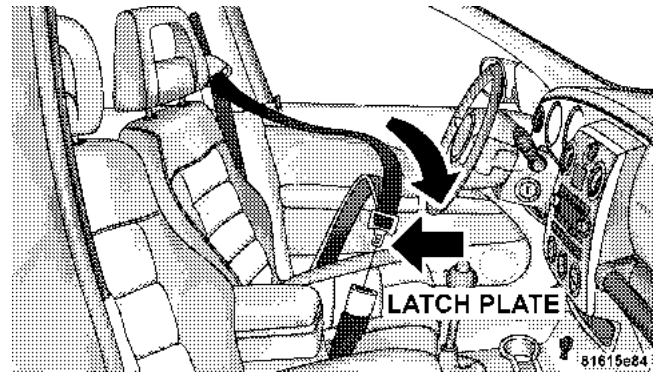
**Latch Plate**

3. When the belt is long enough to fit, insert the latch plate into the buckle until you hear a "click."

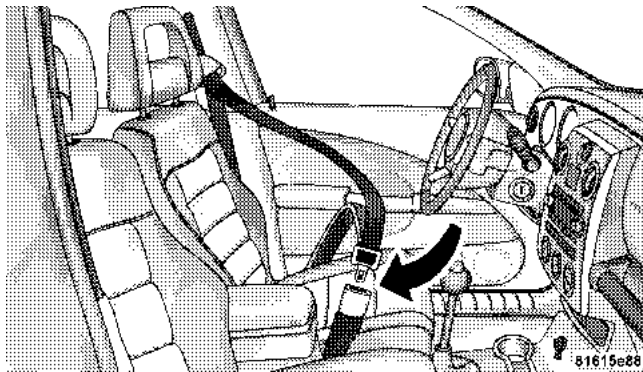

Latch Plate to Buckle

WARNING!

- A belt that is buckled into the wrong buckle will not protect you properly. The lap portion could ride too high on your body, possibly causing internal injuries. Always buckle your belt into the buckle nearest you.
- A belt that is too loose will not protect you as well. In a sudden stop you could move too far forward, increasing the possibility of injury. Wear your seat belt snugly.
- A belt that is worn under your arm is very dangerous. Your body could strike the inside surfaces of the vehicle in a collision, increasing head and neck injury. A belt worn under the arm can cause internal injuries. Ribs aren't as strong as shoulder bones. Wear the belt over your shoulder so that your strongest bones will take the force in a collision.
- A shoulder belt placed behind you will not protect you from injury during a collision. You are more likely to hit your head in a collision if you do not wear your shoulder belt. The lap and shoulder belt are meant to be used together.

4. Position the lap belt across your thighs, below your abdomen. To remove slack in the lap belt portion, pull up on the shoulder belt. To loosen the lap belt if it is too tight, tilt the latch plate and pull on the lap belt. A snug belt reduces the risk of sliding under the belt in a collision.

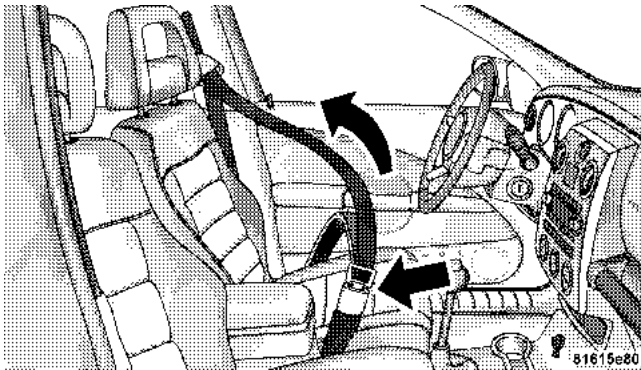

Removing Slack From Belt

WARNING!

- A lap belt worn too high can increase the risk of internal injury in a collision. The belt forces won't be at the strong hip and pelvic bones, but across your abdomen. Always wear the lap belt as low as possible and keep it snug.
- A twisted belt can't do its job as well. In a collision it could even cut into you. Be sure the belt is straight. If you can't straighten a belt in your vehicle, take it to your dealer and have it fixed.

5. Position the shoulder belt on your chest so that it is comfortable and not resting on your neck. The retractor will withdraw any slack in the belt.

6. To release the belt, push the red button on the buckle. The belt will automatically retract to its stowed position. If necessary, slide the latch plate down the webbing to allow the belt to retract fully.

WARNING!

A frayed or torn belt could rip apart in a collision and leave you with no protection. Inspect the belt system periodically, checking for cuts, frays, or loose parts. Damaged parts must be replaced immediately. Do not disassemble or modify the system. Seat belt assemblies must be replaced after a collision if they have been damaged (bent retractor, torn webbing, etc.).

Rear Center Lap/Shoulder Belt Retractor Lock-Out

This feature is designed to lock the retractor whenever the rear seat back is not fully latched. This prevents

someone from wearing the rear center lap/shoulder belt when the rear seat back is not fully latched.

NOTE:

- If the rear center lap/shoulder belt can not be pulled out, check that the rear seat back is fully latched.
- If the rear seat back is properly latched and the rear center lap/shoulder belt still can not be pulled out, the Automatic-Locking Retractor (ALR) system may be activated. To reset this feature you must let all of the belt webbing return into the retractor. You will not be able to pull out more webbing until all of the webbing has been returned back into the retractor.

WARNING!

The rear center lap/shoulder belt is equipped with a lock-out feature to ensure that the rear seat back is in the fully upright and locked position when occupied. If the rear seat back is not fully upright and locked and the rear center lap/shoulder belt can be pulled out of the retractor, the vehicle should immediately be taken to your dealer for service. Failure to follow this warning could result in serious or fatal injury.

Adjustable Upper Shoulder Belt Anchorage

In the front seat, the shoulder belt can be adjusted upward or downward to position the belt away from your neck. Push up or down on the anchorage button to release the anchorage, and move it up or down to the position that serves you best.

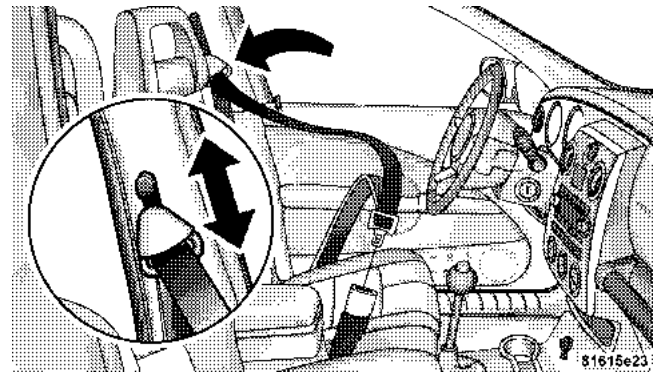
**Adjusting Upper Shoulder Belt**

As a guide, if you are shorter than average, you will prefer a lower position, and if you are taller than average, you'll prefer a higher position. When you release the anchorage, try to move it up or down to make sure that it is locked in position.

Lap/Shoulder Belt Untwisting Procedure

Use the following procedure to untwist a twisted lap/shoulder belt.

1. Position the latch plate as close as possible to the anchor point.

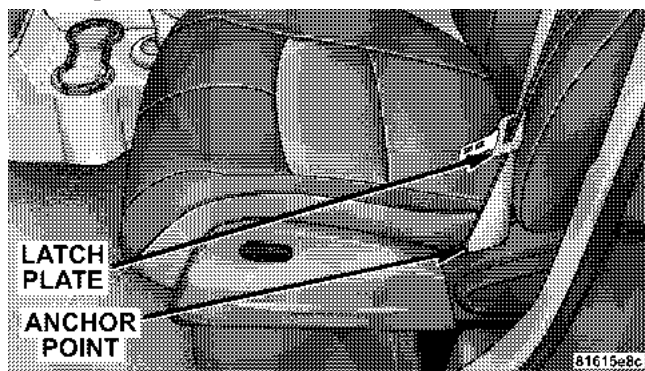

Positioning Latch Plate

2. At about 6 to 12 inches (15 to 30 cm) above the latch plate, grasp and twist the belt webbing 180° to create a fold that begins immediately above the latch plate.

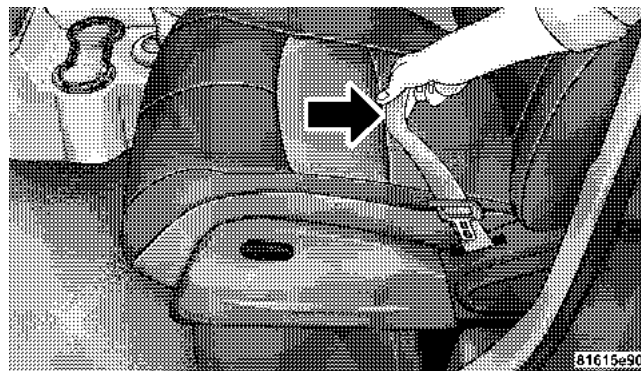

Creating A Fold

3. Slide the latch plate upward over the folded webbing. The folded webbing must enter the slot at the top of the latch plate.

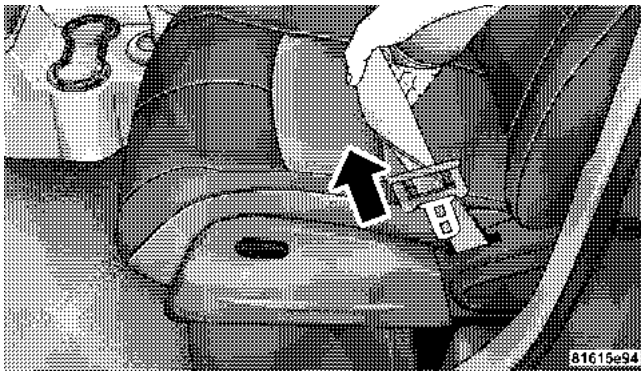

Sliding The Latch Plate

4. Continue to slide the latch plate up until it clears the folded webbing.

Seat Belt Pretensioners

The seat belts for both front seating positions are equipped with pretensioning devices that are designed to remove slack from the seat belt in the event of a collision. These devices improve the performance of the seat belt by assuring that the belt is tight about the occupant early in a collision. Pretensioners work for all size occupants, including those in child restraints.

NOTE: These devices are not a substitute for proper seat belt placement by the occupant. The seat belt still must be worn snugly and positioned properly.

The pretensioners are triggered by the front airbag control module (see Airbag Section). Like the front airbags, the pretensioners are single use items. After a collision that is severe enough to deploy the airbags and pretensioners, both must be replaced.

Enhanced Seat Belt Reminder System (BeltAlert)

If the driver's or front passenger's seat belt has not been buckled within 60 seconds of starting the vehicle and if the vehicle speed is greater than 5 mph (8 km/h), the Enhanced Warning System (BeltAlert) will alert the driver or front passenger to buckle their seat belt. The driver should also instruct all other occupants to buckle their seat belts. Once the warning is triggered, the Enhanced Warning System (BeltAlert) will continue to chime and flash the Seat Belt Warning Light for 96 seconds or until the driver's or front passenger's seat belt is buckled. The Enhanced Warning System (BeltAlert) will be reactivated if the driver's or front passenger's seat belt is unbuckled for more than 10 seconds and the vehicle speed is greater than 5 mph (8 km/h).

The Enhanced Warning System (BeltAlert) can be enabled or disabled by your authorized dealer or by following these steps:

NOTE: The following steps must occur within the first 60 seconds of the ignition switch being turned to the ON or START position. DaimlerChrysler does not recommend deactivating the Enhanced Warning System (BeltAlert).

1. Turn the ignition switch to the LOCK position and buckle the driver's seat belt.
2. Turn the ignition switch to the ON position and wait for the Seat Belt Warning Light to turn off.
3. Within 60 seconds of turning the ignition switch to the ON position, unbuckle and then re-buckle the driver's seat belt at least three times within 10 seconds, ending with the seat belt buckled.

NOTE: Watch for the Seat Belt Warning Light to turn on while unbuckling and off while re-buckling the seat belt. It may be necessary to retract the seat belt.

4. Turn the ignition switch to the LOCK position. A single chime will sound to signify that you have successfully completed the programming.

The Enhanced Warning System (BeltAlert) can be reactivated by repeating this procedure.

NOTE: Although the Enhanced Warning System (BeltAlert) has been deactivated, the Seat Belt Warning Light will continue to illuminate while the driver's or front passenger's seat belt remains unbuckled.

Seat Belts And Pregnant Women

We recommend that pregnant women use the seat belts throughout their pregnancy. Keeping the mother safe is the best way to keep the baby safe.

Pregnant women should wear the lap part of the belt across the thighs and as snug across the hips as possible.

Keep the belt low so that it does not come across the abdomen. That way the strong bones of the hips will take the force if there is a collision.

Driver and Front Passenger Supplemental Restraint System (SRS) - Airbag

This vehicle has airbags for both the driver and front passenger as a supplement to the seat belt restraint systems. The driver's front airbag is mounted in the center of the steering wheel. The passenger's front airbag is mounted in the instrument panel, above the glove compartment. The words SRS AIRBAG are embossed on the airbag covers.

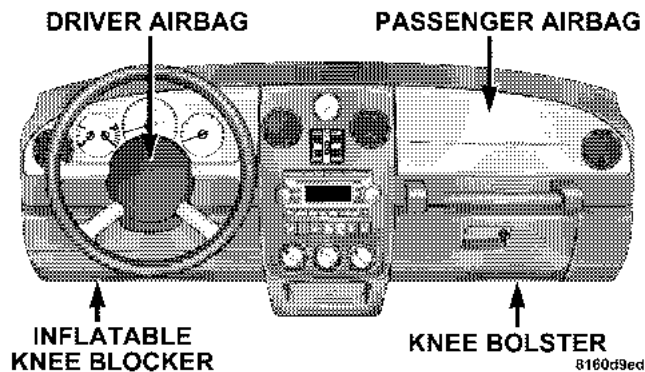

Front Airbag Components

NOTE: The front airbags are certified to the Federal regulations that allow less forceful deployment.

The front airbags have a multistage inflator design. This may allow the airbag to have different rates of inflation that are based on collision severity and occupant size. Also, the front passenger airbag is certified to the Federal

regulations that define Occupant Classification (Refer to "Occupant Classification System" in this section).

If the vehicle is equipped with side airbags, they are located inside the driver and front passenger seats, and their covers are also labeled SRS AIRBAG.

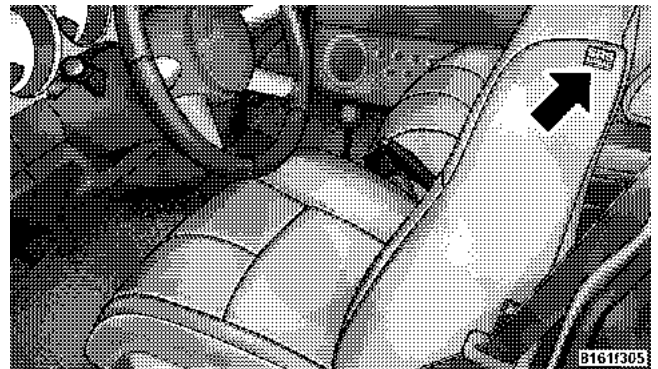

WARNING!

- Do not put anything on or around the airbag covers or attempt to manually open them. You may damage the airbags and you could be injured because the airbags are not there to protect you. These protective covers for the airbag cushions are designed to open only when the airbags are inflating.
- If your vehicle is equipped with side airbags, do not use accessory seat covers or place objects between you and the side airbags; the performance could be adversely affected and/or objects could be pushed into you, causing serious injury.
- If your vehicle is equipped with side airbags, do not attach cup holders or any other objects on or around the door. The inflating side airbag could drive the object into occupants, causing serious injury.

Airbags inflate in moderate to high speed impacts. Along with seat belts and pretensioners, front airbags work with the driver inflatable knee blocker to provide improved protection for the driver and front passenger. Side airbags also work with seat belts to improve occupant protection.

The seat belts are designed to protect you in many types of collisions. The front airbags deploy in moderate to severe frontal collisions. If your vehicle is equipped, the side airbag on the crash side of the vehicle is triggered in moderate to severe side collisions. In certain types of collisions, both the front and side airbags may be triggered. But even in collisions where the airbags work, you need the seat belts to keep you in the right position for the airbags to protect you properly.

NOTE: The passenger front airbag may not deploy even when the driver front airbag has if the Occupant Classification System (refer to "Occupant Classification System" in this section) has determined the passenger seat is

empty or is occupied by someone that is classified in the “child” category. This could be a child, a teenager, or even a small adult.

Here are some simple steps you can take to minimize the risk of harm from a deploying airbag.

1. Children 12 years old and under should always ride buckled up in a rear seat.

Infants in rear facing child restraints should **NEVER** ride in the front seat of a vehicle with a passenger front airbag. An airbag deployment can cause severe injury or death to infants in that position.

Children that are not big enough to properly wear the vehicle seat belt (see Section on Child Restraints) should be secured in the rear seat in child restraints or belt-positioning booster seats. Older children who do not use child restraints or belt-positioning booster seats should

ride properly buckled up in the rear seat. Never allow children to slide the shoulder belt behind them or under their arm.

If a child from 1 to 12 years old must ride in the front passenger seat because the vehicle is crowded, move the seat as far back as possible, and use the proper child restraint. Refer to the section on Child Restraint.

You should read the instructions provided with your child restraint to make sure that you are using it properly.

2. All occupants should wear their lap and shoulder belts properly.

3. The driver and front passenger seats should be moved back as far as practical to allow the front airbags room to inflate.

4. If your vehicle has side airbags, do not lean against the door, airbags will inflate forcefully into the space between you and the door.

5. If the airbag system in this vehicle needs to be modified to accommodate a disabled person, contact the Customer Center. Phone numbers are provided under "If You Need Assistance" in Section 9 of this manual.

WARNING!

- Relying on the airbags alone could lead to more severe injuries in a collision. The airbags work with your seat belt to restrain you properly. In some collisions the airbags won't deploy at all. Always wear your seat belts even though you have airbags.
- Being too close to the steering wheel or instrument panel during front airbag deployment could cause serious injury. Airbags need room to inflate. Sit back, comfortably extending your arms to reach the steering wheel or instrument panel.
- If the vehicle has side airbags, they also need room to inflate. Do not lean against the door. Sit upright in the center of the seat.

The front airbag system consists of the following:

- Occupant Restraint Controller
- Side Remote Acceleration Sensors (If equipped)
- Airbag Warning Light
- Driver Airbag
- Passenger Airbag
- Front Seat Mounted Side Airbags (If equipped)
- Steering Wheel and Column
- Instrument Panel
- Interconnecting Wiring
- Knee Impact Bolsters
- Driver Inflatable Knee Blocker
- Front Acceleration Sensors

- Driver and Front Passenger Seat Belt Pretensioners
- Occupant Classification System (OCS) for the Front Passenger Seat
 - Occupant Classification Module
 - Passenger Airbag Disable (PAD) Indicator Light
 - Weight Sensors

How The Airbag System Works

- The **Occupant Restraint Controller (ORC)** determines if a frontal collision is severe enough to require the airbags to inflate. The front airbag inflators are designed to provide different rates of airbag inflation from direction provided by the ORC. The ORC may also modify the rate of inflation based on the occupant size provided by the Occupant Classification Module. The ORC will not detect roll over.

The ORC also monitors the readiness of the electronic parts of the system whenever the ignition switch is in the START or RUN positions. These include all of the items listed above except the steering wheel and column, and knee bolsters. If the key is in the OFF position, in the ACC position, or not in the ignition, the airbags are not on and will not inflate.

During a moderate-to-severe rear impact the ORC may deploy the seat belt pretensioners alone.



Also, the ORC turns on the AIRBAG warning light and PAD indicator light in the instrument panel for 6 to 8 seconds for a self-check when the ignition is first turned on. After the self-check, the AIRBAG warning light will turn off. The PAD indicator light will function normally (Refer to "Passenger Airbag Disable (PAD) Indicator Light" in this section). If the ORC detects a malfunction in any part of the system, it turns on the AIRBAG warning light either

momentarily or continuously. A single chime will sound if the light comes on again after initial start up.

WARNING!

Ignoring the AIRBAG light in your instrument panel could mean you won't have the airbags to protect you in a collision. If the light does not come on, stays on after you start the vehicle, or if it comes on as you drive, have the airbag system checked right away.

- The **Occupant Classification System (OCS)** is part of a Federally regulated safety system required for this vehicle. It is designed to turn off the front passenger airbag for occupants that weigh less than a very small adult.

NOTE: Children 12 years and under should always ride buckled up in a rear seat in an appropriate child restraint.

62 THINGS TO KNOW BEFORE STARTING YOUR VEHICLE

- The OCS classifies an occupant using weight sensors mounted in the base of the front passenger seat. Any weight on the seat will be sensed by the system. Objects hanging on the seat or other passengers pushing down on the seat will also be sensed. The weight of an adult will cause the system to turn the airbag on. In this case, the OCS has classified the occupant of the seat as an adult. An adult occupant needs to sit in a normal position (with their feet on or near the floor) in order to be properly classified. Reclining the seat back too far may change how an occupant is classified by the OCS.
- The **Passenger Airbag Disable (PAD) Indicator Light** (an amber light located in the center of the instrument panel) tells the driver and front passenger when the front passenger airbag is turned off. The PAD Indicator lamp illuminates the words "PASS AIR BAG OFF" to show that the front passenger airbag will not inflate during a collision requiring airbags. When the right

front passenger seat is empty or when very light objects are placed on the seat, the passenger air bag will not inflate even though the Passenger Airbag Disable (PAD) indicator lamp is not illuminated.

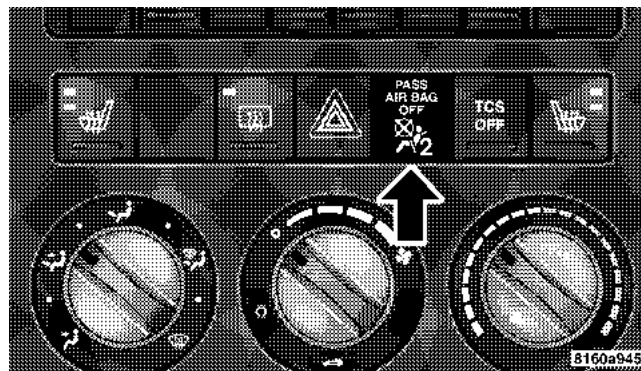

Passenger Airbag Disabled Light

The PAD indicator light should not be illuminated when an adult passenger is properly seated in the

front passenger seat. In this case, the air bag is ready to be inflated if a collision requiring an airbag occurs.

For all other occupants, the PAD indicator light will be illuminated indicating that the front passenger airbag is turned off and will not inflate.

NOTE: Even though this vehicle is equipped with an occupant classification system, children 12 years and under should always ride buckled up in a rear seat in an appropriate child restraint (see section on child restraints).

WARNING!

Never place a rear facing infant seat in front of an airbag. A deploying passenger airbag can cause death or serious injury to a child in a rear facing infant seat.

Front Passenger Seat Occupant	Passenger Airbag Disable (PAD) Indicator Light	Airbag Status
Adult	OFF	ON
Child	ON	OFF
Grocery Bags, Heavy Briefcases and Other Relatively Light Objects	ON	OFF
Empty or Very Small Objects	OFF*	OFF
* Since the system senses weight, some small objects will turn the PAD Indicator Light on.		

Drivers and adult passengers should verify that the PAD Indicator Light is not illuminated when an adult is riding in the front passenger seat. If an adult occupant's weight is transferred to another part of the vehicle (like the door

or instrument panel), the weight sensors in the seat may not properly classify the occupant. Objects lodged under the seat or between the seat and the center console can prevent the occupant's weight from being measured properly and may result in the occupant being improperly classified. Ensure that the front passenger seat back does not touch anything placed on the second row of seats because this can also affect occupant classification. Also, if you fold down the seats in the second row check to be sure they don't touch the front passenger seat.

If the front passenger seat is damaged in any way, it should only be serviced by an authorized dealer. If the seat is removed (or even if the seat attachment bolts are loosened or tightened in any way), take the vehicle to an authorized dealer.

If there is a fault present in the OCS, the Airbag Warning Light (a red light located in the center of the instrument cluster directly in front of the driver) will be turned on.

This indicates that you should take the vehicle to an authorized dealer. The Airbag Warning Light is turned on whenever there is a fault that can affect the operation of the airbag system. If there is a fault present in the OCS, both the PAD Indicator Light and the Airbag Warning Light are illuminated to show that the passenger airbag is turned off until the fault is cleared. If an object is lodged under the seat and interferes with operation of the weight sensors, a fault will occur which turns on both the PAD Indicator Light and the Airbag Warning Light. Once the lodged object is removed, the fault will be automatically cleared after a short period of time.

- The **Driver and Passenger Airbag/Inflator Units** are located in the center of the steering wheel and the right side of the instrument panel. When the ORC detects a collision requiring the airbags, it signals the inflator units. A large quantity of nontoxic gas is generated to inflate the front airbags. Different airbag inflation rates

may be possible based on collision severity and occupant size. The steering wheel hub trim cover and the upper right side of the instrument panel separate and fold out of the way as the bags inflate to their full size. The bags fully inflate in about 50 - 70 milliseconds. This is about half of the time it takes to blink your eyes. The bags then quickly deflate while helping to restrain the driver and front passenger. The driver's front airbag gas is vented through vent holes in the sides of the airbag. The passenger's front airbag gas is vented through vent holes in the sides of the airbag. In this way the airbags do not interfere with your control of the vehicle.

- The **Occupant Classification Module (OCM)** is located beneath the front passenger seat. The OCM classifies the occupant into categories based on the measurements made by the seat weight sensors. The OCM communicates with the Occupant Restraint Controller (ORC). The ORC uses the occupant category to

determine whether the front passenger airbag should be turned off. It also determines the rate of airbag inflation during a collision.

- Your vehicle has four **Weight Sensors** located between the seat and the floor pan. The weight sensors measure applied weight and transfers that information to the OCM.
- The **Side Impact (SRS) Seat Mounted Side Airbags (If equipped)** are designed to activate only in certain side collisions.

The ORC module determines if a side collision is severe enough to require the side airbags to inflate. The side airbag control module will not detect roll over, front or rear collisions.

The ORC Module monitors the readiness of the electronic parts of the system whenever the ignition switch is in the START or ON positions. These include all of the items previously mentioned.

In moderate to severe side collisions, the side airbag inflator on the crash side of the vehicle is triggered, releasing a quantity of nontoxic gas. The inflating side airbag exits through the seat seam into the space between the occupant and the door. The side airbag moves at a very high speed and with such a high force, that it could injure you if you are not seated properly, or if items are positioned in the area where the side airbag inflates. This especially applies to children.

- When the ORC and the impact sensors detect a collision requiring the **Driver Inflatable Knee Blocker**, it signals the inflator unit. A quantity of nontoxic gas is generated to inflate the Driver Inflatable Knee Blocker. The Driver Inflatable Knee Blocker

inflates rearward towards the driver's knees to help protect the knees and position you for the best interaction with the front airbag. The Driver Inflatable Knee Blocker fully inflates in about 50 milliseconds, this is only about half of the time it takes you to blink your eyes. It then quickly deflates while helping to protect the driver's knees.

- The **Knee Impact Bolsters** help protect the knees, and position everyone for the best interaction with the front airbag.

The front passenger seat assembly contains critical components that affect the front passenger airbag deployment. Correctly functioning front passenger seat components are critical for the Occupant Classification System (OCS) to properly classify the front passenger and calculate the proper airbag deployment. Do not make any modifications to the front passenger seat components, assembly, or to the seat cover.

The following requirements must be strictly adhered to:

- Do not modify the front passenger seat assembly or components in any way.
 - Do not modify the front seat center console or center position seat in any way.
 - Do not use prior or future model year seat covers not designated for the specific model being repaired. Always use the correct seat cover specified for the vehicle.
 - Do not replace the seat cover with an aftermarket seat cover.
 - Do not add a secondary seat cover other than those approved by DaimlerChrysler/Mopar.
- At no time should any supplemental restraint system (SRS) component or SRS related component or fastener be modified or replaced with any part except those which are approved by DaimlerChrysler/Mopar.

WARNING!

Unapproved modifications or service procedures to the front passenger seat assembly, its related components, or seat cover may inadvertently change the airbag deployment in case of a frontal crash. This could result in death or serious injury to the front seat passenger if the vehicle is involved in an accident. A modified vehicle may not comply with required Federal Motor Vehicle Safety Standards (FMVSS).

If A Deployment Occurs

The airbag systems are designed to deploy when the airbag control modules detect a moderate-to-severe collision, to help restrain the driver and front passenger, and then immediately deflate.

NOTE: A frontal collision that is not severe enough to need airbag protection will not activate the system. This does not mean something is wrong with the airbag system.

If you do have a collision which deploys the airbags, any or all of the following may occur:

- The nylon airbag material may sometimes cause abrasions and/or skin reddening to the driver and front passenger as the airbags deploy and unfold. The abrasions are similar to friction rope burns or those you might get sliding along a carpet or gymnasium floor. They are not caused by contact with chemicals. They are not permanent and normally heal quickly.
- It is not advisable to drive your vehicle after the airbags have deployed. If you are involved in another collision, the airbags will not be in place to protect you.

However, if you haven't healed significantly within a few days, or if you have any blistering, see your doctor immediately. As the airbags deflate you may see some smoke-like particles. The particles are a normal by-product of the process that generates the nontoxic gas used for airbag inflation. These airborne particles may irritate the skin, eyes, nose, or throat. If you have skin or eye irritation, rinse the area with cool water. For nose or throat irritation, move to fresh air. If the irritation continues, see your doctor. If these particles settle on your clothing, follow the garment manufacturer's instructions for cleaning.

WARNING!

Deployed airbags and seat belt pretensioners cannot protect you in another collision. Have the airbags, seat belt pretensioners, and the front passenger seat belt retractor assembly, replaced by an authorized dealer as soon as possible. Also, have the Occupant Classification System serviced as well.

Maintaining Your Airbag System

WARNING!

- Modifications to any part of the airbag system could cause it to fail when you need it. You could be injured if the airbag system is not there to protect you. Do not modify the components or wiring, including adding any kind of badges or stickers to the steering wheel hub trim cover or the upper right side of the instrument panel. Do not modify the front bumper, vehicle body structure, or add aftermarket side steps or running boards.
- Do not attempt to modify any part of your advanced airbag system. The airbag may inflate accidentally or may not function properly if modifications are made. Take your vehicle to an authorized dealer for any advanced airbag system service. If your seat including your trim cover and cushion needs to be serviced in any way (including removal or loosening/tightening of seat attachment bolts), take the vehicle to your authorized dealer. Only manufacturer approved seat accessories may be used. If it is necessary to modify an advanced airbag system for persons with disabilities, contact your authorized dealer.
- Do not place or hang any items such as add-on video players on the right front passenger seat back. The additional weight may cause the Occupant Classification System to be unable to correctly classify the right front occupant. This could allow the passenger frontal airbag to inflate when it is not desired.
- You need proper knee impact protection in a collision. Do not mount or locate any aftermarket equipment on or behind the knee bolsters/ driver inflatable knee blocker.
- It is dangerous to try to repair any part of the airbag system yourself. Be sure to tell anyone who works on your vehicle that it has an airbag system.

Airbag Light

You will want to have the airbags ready to inflate for your protection in a collision. While the airbag system is designed to be maintenance free, if any of the following occurs, have an authorized dealer service the system immediately.

- The AIRBAG light does not come on during the 6 to 8 seconds when the ignition switch is first turned on.
- The light remains on after the 6 to 8 second interval.
- The light comes on and remains on while driving.

Event Data Recorder (EDR)

In the event of an airbag deployment, your vehicle is designed to record up to 2-seconds of specific vehicle data parameters (see list below) in an event data recorder prior to the moment of airbag deployment. Please note that such data are ONLY recorded if an airbag deploys, and are otherwise unavailable. In conjunction with other

data gathered during a complete accident investigation, the electronic data may be used by DaimlerChrysler and others to learn more about the possible causes of crashes and associated injuries in order to assess and improve vehicle performance. In addition to crash investigations initiated by DaimlerChrysler, such investigations may be requested by customers, insurance carriers, government officials, and professional crash researchers, such as those associated with universities, and with hospital and insurance organizations.

In the event that an investigation is undertaken by DaimlerChrysler (regardless of initiative), the company or its designated representative will first obtain permission of the appropriate custodial entity for the vehicle (usually the vehicle owner or lessee) before accessing the electronic data stored, unless ordered to download data by a court with legal jurisdiction (i.e., pursuant to a warrant). A copy of the data will be provided to the custodial entity upon request. General data that does not

identify particular vehicles or crashes may be released for incorporation in aggregate crash databases, such as those maintained by the US government and various states. Data of a potentially sensitive nature, such as would identify a particular driver, vehicle, or crash, will be treated confidentially. Confidential data will not be disclosed by DaimlerChrysler to any third party except when:

1. Used for research purposes, such as to match data with a particular crash record in an aggregate database, provided confidentiality of personal data is thereafter preserved
2. Used in defense of litigation involving a DaimlerChrysler product
3. Requested by police under a legal warrant
4. Otherwise required by law

Data Parameters that May Be Recorded:

- Diagnostic trouble code(s) and warning lamp status for electronically-controlled safety systems, including the airbag system
- Airbag disable lamp status (if equipped)
- "Time" of airbag deployment (in terms of ignition cycles and vehicle mileage)
- Airbag deployment level (if applicable)
- Seatbelt status
- Brake status (service and parking brakes)
- Accelerator status (including vehicle speed)
- Engine control status (including engine speed)
- Cruise control status
- Traction/stability control status

Child Restraint

Everyone in your vehicle needs to be buckled up at all times — babies and children, too. Every state in the United States and all Canadian provinces require that small children ride in proper restraint systems. This is the law, and you can be prosecuted for ignoring it.

Children 12 years and under should ride properly buckled up in a rear seat, if available. According to crash statistics, children are safer when properly restrained in the rear seats, rather than in the front.

WARNING!

In a collision, an unrestrained child, even a tiny baby, can become a missile inside the vehicle. The force required to hold even an infant on your lap could become so great that you could not hold the child, no matter how strong you are. The child and others could be badly injured. Any child riding in your vehicle should be in a proper restraint for the child's size.

Infants And Small Children

There are different sizes and types of restraints for children from newborn size to the child almost large enough for an adult safety belt. Always check the child seat owner's manual to ensure you have the correct seat for your child. Use the restraint that is correct for your child:

- Safety experts recommend that children ride rearward-facing in the vehicle until they are at least one year old and weigh at least 20 lbs (9 kg). Two types of child restraints can be used rearward-facing: infant carriers and "convertible" child seats. Both types of child restraints are held in the vehicle by the lap/shoulder belt or the LATCH child restraint anchorage system.
- The infant carrier is only used rearward-facing in the vehicle. It is recommended for children who weigh up to about 20 lbs (9 kg). "Convertible" child seats can be used either rearward-facing or forward-facing in the vehicle. Convertible child seats often have a higher weight limit in the rearward-facing direction than infant carriers do, so they can be used rearward-facing by children who weigh more than 9 kg (20 lbs) but are less than one year old.
- Rearward-facing child seats must **NEVER** be used in the front seat of a vehicle with a front passenger airbag. An airbag deployment could cause severe injury or death to infants in this position.
- Children who weigh more than 20 lbs (9 kg) and who are older than one year can ride forward-facing in the vehicle. Forward-facing child seats and convertible child seats used in the forward-facing direction are for children who weigh 20 to 40 lbs (9 to 18 kg) and who are older than one year. These child seats are also held in the vehicle by the lap/shoulder belt or the LATCH child restraint anchorage system.
- The belt-positioning booster seat is for children weighing more than 40 lbs (18 kg), but who are still too small to fit the vehicle's seat belts properly. If the child cannot sit with knees bent over the vehicle's cushion while the child's back is against the seat back; they should use a Belt Positioning Booster Seat. The child and booster seat

74 THINGS TO KNOW BEFORE STARTING YOUR VEHICLE

are held in the vehicle by the lap/shoulder belt. (Some booster seats are equipped with a front shield and are held in the vehicle by the lap portion.)

NOTE: For additional information refer to www.nhtsa.dot.gov or www.seatcheck.org.

WARNING!

- **Improper installation can lead to failure of an infant or child restraint. It could come loose in a collision. The child could be badly injured or killed. Follow the manufacturer's directions exactly when installing an infant or child restraint.**
- **A rearward facing child restraint should only be used in a rear seat. A rearward facing child restraint in the front seat may be struck by a deploying passenger airbag which may cause severe or fatal injury to the infant.**

Here are some tips on getting the most out of your child restraint:

- Before buying any restraint system, make sure that it has a label certifying that it meets all applicable Safety Standards. We also recommend that you make sure that you can install the child restraint in the vehicle where you will use it, before you buy it.
- The restraint must be appropriate for your child's weight and height. Check the label on the restraint for weight and height limits.
- Carefully follow the instructions that come with the restraint. If you install the restraint improperly, it may not work when you need it.

The passenger seat belts are equipped with either cinching latch plates or seat belt retractors that can be switched to an automatic locking mode, which are designed to keep the lap portion tight around the child

restraint so that it is not necessary to use a locking clip. If the seat belt has a cinching latch plate, pulling up on the shoulder portion of the lap/shoulder belt will tighten the belt. The cinching latch plate will keep the belt tight, however, any seat belt system will loosen with time, so check the belt occasionally and pull it tight if necessary.

If the seat belt has a switchable retractor, it will have a distinctive label. To operate the switchable retractor, please refer to Automatic-Locking Retractor (ALR) in this section.

- In the rear seat, you may have trouble tightening the lap/shoulder belt on the child restraint because the buckle or latch plate is too close to the belt path opening on the restraint. Disconnect the latch plate from the buckle and twist the short buckle end of the belt several times to shorten it. Insert the latch plate into the buckle with the release button facing out.

- If the belt still can't be tightened, or if by pulling and pushing on the restraint loosens the belt, disconnect the latch plate from the buckle, turn the latch plate around, and insert the latch plate into the buckle again. If you still can't make the child restraint secure, try a different seating position.

- Buckle the child into the seat according to the child restraint manufacturer's directions.
- When your child restraint is not in use, secure it in the vehicle with the seat belt or remove it from the vehicle. Don't leave it loose in the vehicle. In a sudden stop or collision, it could strike the occupants or seat backs and cause serious personal injury.

Automatic-Locking Retractor (ALR)

To operate the switchable retractor, pull the belt from the retractor until there is enough to allow you to pass through the child restraint and slide the latch plate into the buckle. Then pull on the belt until it is all removed

from the retractor. Allow the belt to return into the retractor, pulling on the excess webbing to tighten the lap portion about the child restraint. Follow the instructions of the child restraint manufacture.

NOTE: To reset this feature you must let all of the belt webbing return into the retractor. You will not be able to pull out more webbing until all of the webbing has been returned back into the retractor.

Lower Anchors and Tether for Children (LATCH)

Your vehicle is equipped with the child restraint anchorage system called LATCH, which stands for Lower Anchors and Tether for CHildren. The LATCH system provides for the installation of the child restraint without using the vehicle seat belt. All three rear seating positions have lower anchorages that are capable of accommodating LATCH-compatible child seats having flexible, webbing-mounted lower attachments. Child seats with

fixed lower attachments must be installed in the outboard positions only. Regardless of the specific type of lower attachment, **NEVER** install LATCH-compatible child seats such that two seats share a common lower anchorage. If you are installing LATCH-compatible child restraints in adjacent rear seating positions, you can use the LATCH anchors or the vehicle's seat belt for the outboard position, but you must use the vehicle's seat belt at the center position. If your child restraints are not LATCH-compatible, you can only install the child restraints using the vehicle's seat belts. Please refer to, *Installing the Child Restraint System* for typical installation instructions.

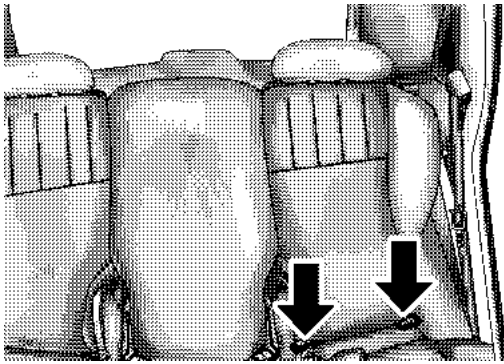

80f0e8af

Latch Anchorages

Child restraints systems having attachments designed to connect to the lower anchorages are now available. Child restraints having tether straps and hooks for connection to the top tether anchorage have been available for some time. In fact, many child restraint manufacturers will

provide add-on tether strap kits for some of their older products. Tether anchorage kits are also available for most older vehicles.

Because the lower anchorages are to be introduced to passenger carrying vehicles over a period of years, child restraint systems having attachments for those anchorages will continue to have features for installation in vehicles using the lap or lap/shoulder belt. They will also have tether straps, and you are urged to take advantage of all of the available attachments provided with your child restraint in any vehicle.

NOTE: When using the LATCH attaching system to install a child restraint, please ensure that all seat belts not being used for occupant restraints are stowed and out of reach of children. It is recommended that before installing the child restraint, buckle the seat belt so the seat belt is tucked behind the child restraint and out of reach. If the buckled seat belt interferes with the child

restraint installation, instead of tucking the seat belt behind the child restraint, route the seat belt through the child restraint belt path and then buckle it. This should stow the seat belt out of the reach of an inquisitive child. Remind all children in the vehicle that the seat belts are not toys and should not be played with, and never leave your child unattended in the vehicle.

Installing the Child Restraint System

We urge that you carefully follow the directions of the manufacturer when installing your child restraint. Many, but not all, restraint systems will be equipped with separate straps on each side, with each having a hook or connector and a means for adjusting the tension in the strap. Forward-facing toddler restraints and some rearward-facing infant restraints will also be equipped with a tether strap with a hook and means for adjusting the tension in the strap.

In general, you will first loosen the adjusters on the lower and tether straps so that you can more easily attach the hook or connector to the lower and tether anchorages. The tether strap should be routed under the center of the head restraint and attached to the tether anchor on the rear of the seat back. Then tighten all three straps as you push the child restraint rearward and downward into the seat.

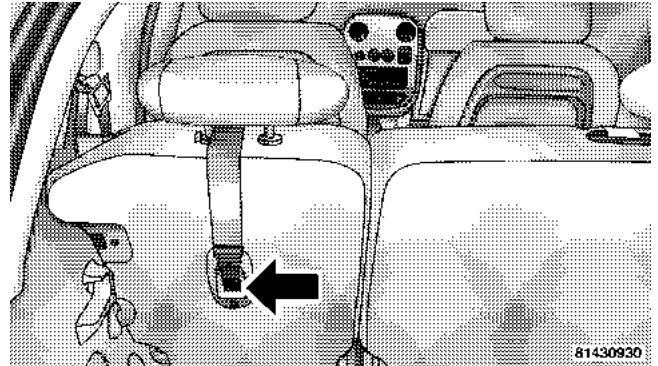

Tether Strap Mounting

Not all child restraint systems will be installed as we have described here. Again, carefully follow the instructions that come with the child restraint system.

NOTE: If your child restraint seat is not LATCH compatible, install the restraint using the vehicle seat belts.

WARNING!

An incorrectly anchored tether strap could lead to increased head motion and possible injury to the child. Use only the anchor position directly behind the child seat to secure a child restraint top tether strap.

Children Too Large For Booster Seats

Children who are large enough to wear the shoulder belt comfortably, and whose legs are long enough to bend

over the front of the seat when their back is against the seat back, should use the lap/shoulder belt in a rear seat.

- Make sure that the child is upright in the seat.
- The lap portion should be low on the hips and as snug as possible.
- Check belt fit periodically. A child’s squirming or slouching can move the belt out of position.
- If the shoulder belt contacts the face or neck, move the child closer to the center of the vehicle. Never allow a child to put the shoulder belt under an arm or behind their back.

Transporting Pets

Airbags deploying in the front seat could harm your pet. An unrestrained pet will be thrown about and possibly injured, or injure a passenger during panic braking or in a collision.

Pets should be restrained in the rear seat in pet harnesses or pet carriers that are secured by seat belts.

OCCUPANT RESTRAINTS (CONVERTIBLE)

Some of the most important safety features in your vehicle are the restraint systems. These include the front and rear seat belts for the driver and all passengers, front airbags for both the driver and front passenger and if equipped, side airbags for both the driver and front passenger. If you will be carrying children too small for adult-size seat belts, your seat belts or the LATCH feature also, can be used to hold infant and child restraint systems.

Please pay close attention to the information in this section. It tells you how to use your restraint system properly to keep you and your passengers as safe as possible.

WARNING!

In a collision, you and your passengers can suffer much greater injuries if you are not properly buckled up. You can strike the interior of your vehicle or other passengers, or you can be thrown out of the vehicle. Always be sure you and others in your vehicle are buckled up properly.

Buckle up even though you are an excellent driver, even on short trips. Someone on the road may be a poor driver and cause a collision that includes you. This can happen far away from home or on your own street.

Research has shown that seat belts save lives, and they can reduce the seriousness of injuries in a collision. Some of the worst injuries happen when people are thrown from the vehicle. Seat belts reduce the possibility of

ejection and the risk of injury caused by striking the inside of the vehicle. **Everyone** in a motor vehicle should be belted at all times.

Lap/Shoulder Belts

All the seats in your vehicle are equipped with Lap/Shoulder Belts.

If the belt webbing is twisted, and comes in contact with the wearers body, the twisted belt should be corrected using the Lap/Shoulder belt untwisting procedure found in this section.

The belt webbing retractor is designed to lock during very sudden stops or collisions. This feature allows the shoulder part of the belt to move freely with you under normal conditions. But in a collision, the belt will lock and reduce the risk of your striking the inside of the vehicle or being thrown out.

WARNING!

- **It is extremely dangerous to ride in a cargo area, inside or outside of a vehicle. In a collision, people riding in these areas are more likely to be seriously injured or killed.**
- **Do not allow people to ride in any area of your vehicle that is not equipped with seats and seat belts.**
- **Be sure everyone in your vehicle is in a seat and using a seat belt properly.**

WARNING!

- Wearing a seat belt incorrectly is dangerous. Seat belts are designed to go around the large bones of your body. These are the strongest parts of your body and can take the forces of a collision the best.
- Wearing your belt in the wrong place could make your injuries in a collision much worse. You might suffer internal injuries, or you could even slide out of part of the belt. Follow these instructions to wear your seat belt safely and to keep your passengers safe, too.
- Two people should never be belted into a single seat belt. People belted together can crash into one another in an accident, hurting one another badly. Never use a lap/shoulder belt or lap belt for more than one person, no matter what their size.

Lap/Shoulder Belt Operating Instructions

1. Enter the vehicle and close the door. Sit back and adjust the seat.
2. The seat belt latch plate is above the back of the front seat, next to your arm. Grasp the latch plate and pull out the belt. Slide the latch plate up the webbing as far as necessary to allow the belt to go around your lap.

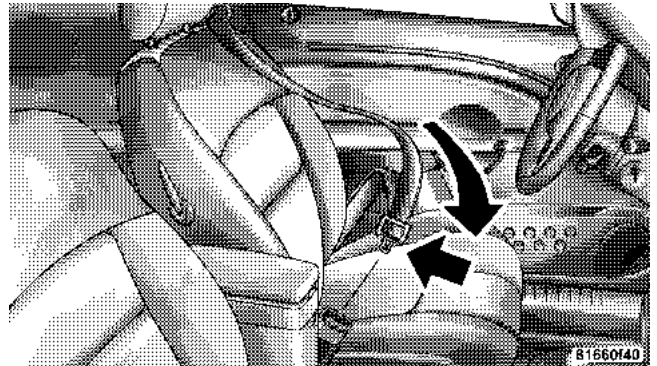

Latch Plate

3. When the belt is long enough to fit, insert the latch plate into the buckle until you hear a “click.”

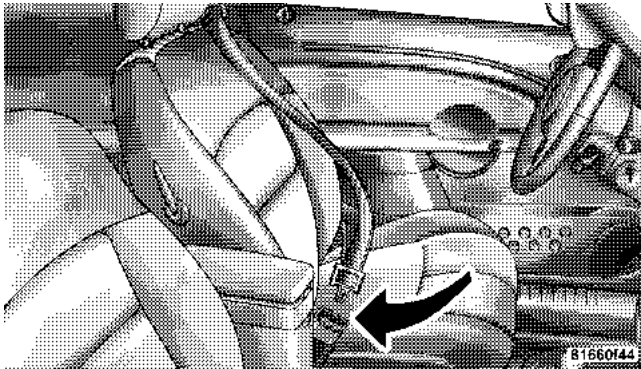

Latch Plate To Buckle

WARNING!

- A belt that is buckled into the wrong buckle will not protect you properly. The lap portion could ride too high on your body, possibly causing internal injuries. Always buckle your belt into the buckle nearest you.
- A belt that is too loose will not protect you as well. In a sudden stop you could move too far forward, increasing the possibility of injury. Wear your seat belt snugly.
- A belt that is worn under your arm is very dangerous. Your body could strike the inside surfaces of the vehicle in a collision, increasing head and neck injury. A belt worn under the arm can cause internal injuries. Ribs aren't as strong as shoulder bones. Wear the belt over your shoulder so that your strongest bones will take the force in a collision.
- A shoulder belt placed behind you will not protect you from injury during a collision. You are more likely to hit your head in a collision if you do not wear your shoulder belt. The lap and shoulder belt are meant to be used together.

4. Position the lap belt across your thighs, below your abdomen. To remove slack in the lap belt portion, pull up on the shoulder belt. To loosen the lap belt if it is too tight, tilt the latch plate and pull on the lap belt. A snug belt reduces the risk of sliding under the belt in a collision.

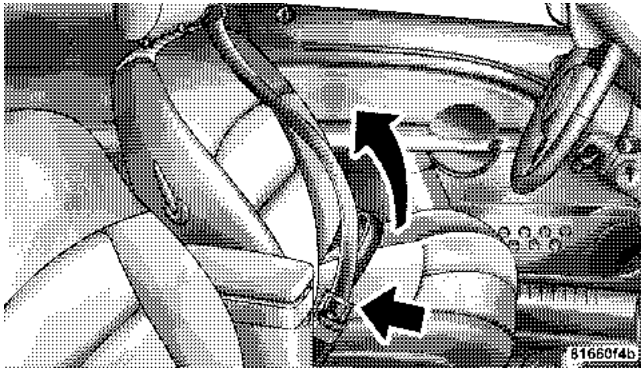

Removing Slack From Belt

WARNING!

- A lap belt worn too high can increase the risk of internal injury in a collision. The belt forces won't be at the strong hip and pelvic bones, but across your abdomen. Always wear the lap belt as low as possible and keep it snug.
- A twisted belt can't do its job as well. In a collision it could even cut into you. Be sure the belt is straight. If you can't straighten a belt in your vehicle, take it to your dealer and have it fixed.

5. Position the shoulder belt on your chest so that it is comfortable and not resting on your neck. The retractor will withdraw any slack in the belt.

6. To release the belt, push the red button on the buckle. The belt will automatically retract to its stowed position. If necessary, slide the latch plate down the webbing to allow the belt to retract fully.

WARNING!

A frayed or torn belt could rip apart in a collision and leave you with no protection. Inspect the belt system periodically, checking for cuts, frays, or loose parts. Damaged parts must be replaced immediately. Do not disassemble or modify the system. Seat belt assemblies must be replaced after a collision if they have been damaged (bent retractor, torn webbing, etc.).

Seat Belt Webbing Guide

NOTE: The manufacturer recommends that the seat belt is routed through the seat belt webbing guide when using the seatbelt.

The seat belt webbing guide should be used to improve seat belt accessibility. The seat belt can be removed from the guide to allow for easier access to the rear seats.

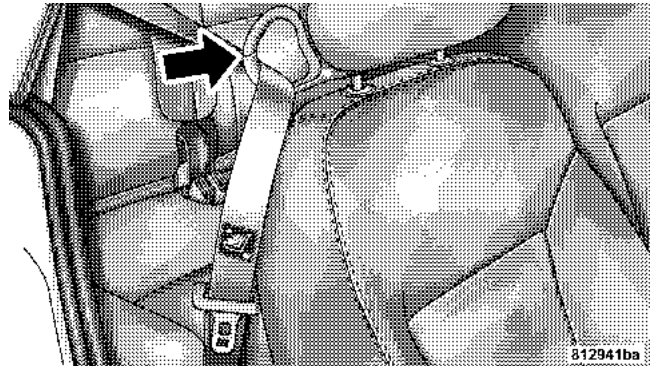

Seat Belt Webbing Guide

Lap/Shoulder Belt Untwisting Procedure

Use the following procedure to untwist a twisted lap/shoulder belt.

1. Position the latch plate as close as possible to the anchor point.

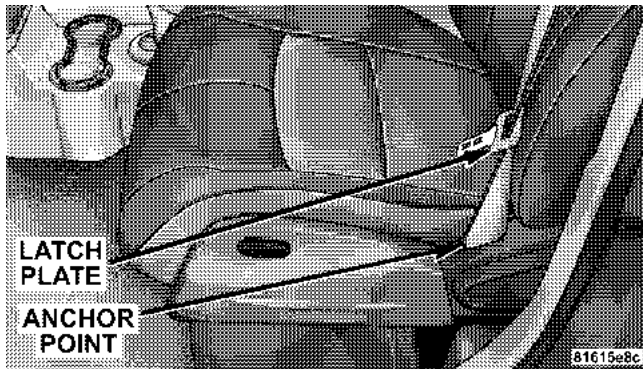

Positioning Latch Plate

2. At about 6 to 12 inches (15 to 30 cm) above the latch plate, grasp and twist the belt webbing 180° to create a fold that begins immediately above the latch plate.

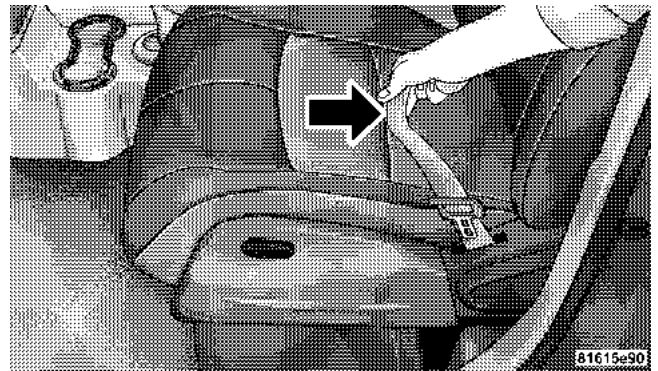

Creating A Fold

3. Slide the latch plate upward over the folded webbing. The folded webbing must enter the slot at the top of the latch plate.

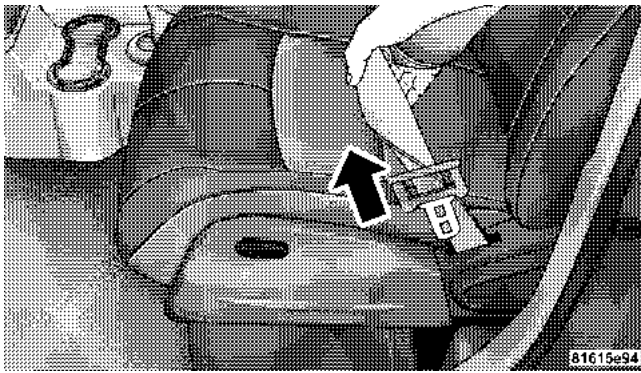

Sliding The Latch Plate

4. Continue to slide the latch plate up until it clears the folded webbing.

Seat Belt Pretensioners

The seat belts for both front seating positions are equipped with pretensioning devices that are designed to remove slack from the seat belt in the event of a collision. These devices improve the performance of the seat belt by assuring that the belt is tight about the occupant early in a collision. Pretensioners work for all size occupants, including those in child restraints.

NOTE: These devices are not a substitute for proper seat belt placement by the occupant. The seat belt still must be worn snugly and positioned properly.

The pretensioners are triggered by the front airbag control module (see Airbag Section). Like the front airbags, the pretensioners are single use items. After a collision that is severe enough to deploy the airbags and pretensioners, both must be replaced.

Enhanced Seat Belt Reminder System (BeltAlert)

If the driver's or front passenger's seat belt has not been buckled within 60 seconds of starting the vehicle and if the vehicle speed is greater than 5 mph (8 km/h), the Enhanced Warning System (BeltAlert) will alert the driver or front passenger to buckle their seat belt. The driver should also instruct all other occupants to buckle their seat belts. Once the warning is triggered, the Enhanced Warning System (BeltAlert) will continue to chime and flash the Seat Belt Warning Light for 96 seconds or until the driver's or front passenger's seat belt is buckled. The Enhanced Warning System (BeltAlert) will be reactivated if the driver's or front passenger's seat belt is unbuckled for more than 10 seconds and the vehicle speed is greater than 5 mph (8 km/h).

The Enhanced Warning System (BeltAlert) can be enabled or disabled by your authorized dealer or by following these steps:

NOTE: The following steps must occur within the first 60 seconds of the ignition switch being turned to the ON or START position. DaimlerChrysler does not recommend deactivating the Enhanced Warning System (BeltAlert).

1. Turn the ignition switch to the LOCK position and buckle the driver's seat belt.
2. Turn the ignition switch to the ON position and wait for the Seat Belt Warning Light to turn off.
3. Within 60 seconds of turning the ignition switch to the ON position, unbuckle and then re-buckle the driver's seat belt at least three times within 10 seconds, ending with the seat belt buckled.

NOTE: Watch for the Seat Belt Warning Light to turn on while unbuckling and off while re-buckling the seat belt. It may be necessary to retract the seat belt.

4. Turn the ignition switch to the LOCK position. A single chime will sound to signify that you have successfully completed the programming.

The Enhanced Warning System (BeltAlert) can be reactivated by repeating this procedure.

NOTE: Although the Enhanced Warning System (BeltAlert) has been deactivated, the Seat Belt Warning Light will continue to illuminate while the driver's or front passenger's seat belt remains unbuckled.

Seat Belts And Pregnant Women

We recommend that pregnant women use the seat belts throughout their pregnancy. Keeping the mother safe is the best way to keep the baby safe.

Pregnant women should wear the lap part of the belt across the thighs and as snug across the hips as possible.

Keep the belt low so that it does not come across the abdomen. That way the strong bones of the hips will take the force if there is a collision.

Driver and Front Passenger Supplemental Restraint System (SRS) - Airbag

This vehicle has airbags for both the driver and front passenger as a supplement to the seat belt restraint systems. The driver's front airbag is mounted in the center of the steering wheel. The passenger's front airbag is mounted in the instrument panel, above the glove compartment. The words SRS AIRBAG are embossed on the airbag covers.

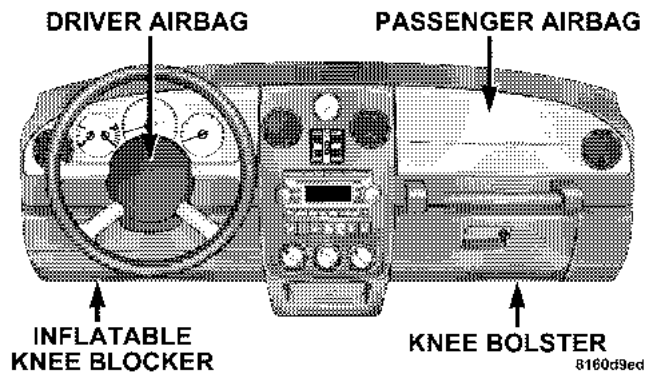

Front Airbag Components

NOTE: The front airbags are certified to the Federal regulations that allow less forceful deployment.

The front airbags have a multistage inflator design. This may allow the airbag to have different rates of inflation that are based on collision severity and occupant size. Also, the front passenger airbag is certified to the Federal

regulations that define Occupant Classification (Refer to "Occupant Classification System" in this section).

If the vehicle is equipped with side airbags, they are located inside the driver and front passenger seats, and their covers are also labeled SRS AIRBAG.

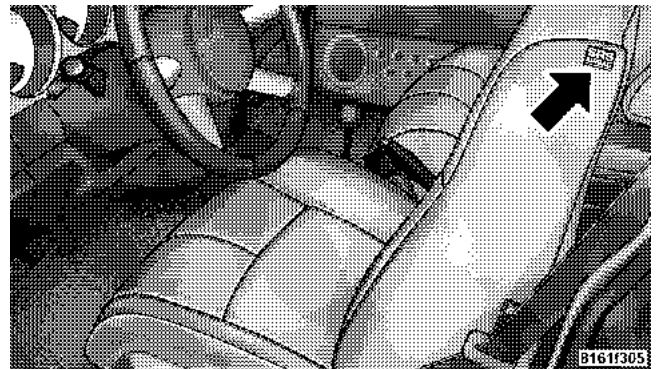

WARNING!

- Do not put anything on or around the airbag covers or attempt to manually open them. You may damage the airbags and you could be injured because the airbags are not there to protect you. These protective covers for the airbag cushions are designed to open only when the airbags are inflating.
- If your vehicle is equipped with side airbags, do not use accessory seat covers or place objects between you and the side airbags; the performance could be adversely affected and/or objects could be pushed into you, causing serious injury.
- If your vehicle is equipped with side airbags, do not attach cup holders or any other objects on or around the door. The inflating side airbag could drive the object into occupants, causing serious injury.

Airbags inflate in moderate to high speed impacts. Along with seat belts and pretensioners, front airbags work with the driver inflatable knee blocker to provide improved protection for the driver and front passenger. Side airbags also work with seat belts to improve occupant protection.

The seat belts are designed to protect you in many types of collisions. The front airbags deploy in moderate to severe frontal collisions. If your vehicle is equipped, the side airbag on the crash side of the vehicle is triggered in moderate to severe side collisions. In certain types of collisions, both the front and side airbags may be triggered. But even in collisions where the airbags work, you need the seat belts to keep you in the right position for the airbags to protect you properly.

NOTE: The passenger front airbag may not deploy even when the driver front airbag has if the Occupant Classification System (refer to "Occupant Classification System" in this section) has determined the passenger seat is

empty or is occupied by someone that is classified in the “child” category. This could be a child, a teenager, or even a small adult.

Here are some simple steps you can take to minimize the risk of harm from a deploying airbag.

1. Children 12 years old and under should always ride buckled up in a rear seat.

Infants in rear facing child restraints should **NEVER** ride in the front seat of a vehicle with a passenger front airbag. An airbag deployment can cause severe injury or death to infants in that position.

Children that are not big enough to properly wear the vehicle seat belt (see Section on Child Restraints) should be secured in the rear seat in child restraints or belt-positioning booster seats. Older children who do not use child restraints or belt-positioning booster seats should

ride properly buckled up in the rear seat. Never allow children to slide the shoulder belt behind them or under their arm.

If a child from 1 to 12 years old must ride in the front passenger seat because the vehicle is crowded, move the seat as far back as possible, and use the proper child restraint. Refer to the section on Child Restraint.

You should read the instructions provided with your child restraint to make sure that you are using it properly.

2. All occupants should wear their lap and shoulder belts properly.

3. The driver and front passenger seats should be moved back as far as practical to allow the front airbags room to inflate.

4. If your vehicle has side airbags, do not lean against the door, airbags will inflate forcefully into the space between you and the door.

5. If the airbag system in this vehicle needs to be modified to accommodate a disabled person, contact the Customer Center. Phone numbers are provided under "If You Need Assistance" in Section 9 of this manual.

WARNING!

- Relying on the airbags alone could lead to more severe injuries in a collision. The airbags work with your seat belt to restrain you properly. In some collisions the airbags won't deploy at all. Always wear your seat belts even though you have airbags.
- Being too close to the steering wheel or instrument panel during front airbag deployment could cause serious injury. Airbags need room to inflate. Sit back, comfortably extending your arms to reach the steering wheel or instrument panel.
- If the vehicle has side airbags, they also need room to inflate. Do not lean against the door. Sit upright in the center of the seat.

The front airbag system consists of the following:

- Occupant Restraint Controller
- Side Remote Acceleration Sensors (If Equipped)
- Airbag Warning Light
- Driver Airbag
- Passenger Airbag
- Front Seat Mounted Side Airbags (If equipped)
- Steering Wheel and Column
- Instrument Panel
- Interconnecting Wiring
- Knee Impact Bolsters
- Driver Inflatable Knee Blocker
- Front Acceleration Sensors

- Driver and Front Passenger Seat Belt Pretensioners
- Occupant Classification System (OCS) for the Front Passenger Seat
 - Occupant Classification Module
 - Passenger Airbag Disable (PAD) Indicator Light
 - Weight Sensors

How The Airbag System Works

- The **Occupant Restraint Controller (ORC)** determines if a frontal collision is severe enough to require the airbags to inflate. The front airbag inflators are designed to provide different rates of airbag inflation from direction provided by the ORC. The ORC may also modify the rate of inflation based on the occupant size provided by the Occupant Classification Module. The ORC will not detect roll over.

The ORC also monitors the readiness of the electronic parts of the system whenever the ignition switch is in the START or RUN positions. These include all of the items listed above except the steering wheel and column, and knee bolsters. If the key is in the OFF position, in the ACC position, or not in the ignition, the airbags are not on and will not inflate.

During a moderate-to-severe rear impact the ORC may deploy the seat belt pretensioners alone.



Also, the ORC turns on the AIRBAG warning light and PAD indicator light in the instrument panel for 6 to 8 seconds for a self-check when the ignition is first turned on. After the self-check, the AIRBAG warning light will turn off. The PAD indicator light will function normally (Refer to "Passenger Airbag Disable (PAD) Indicator Light" in this section). If the ORC detects a malfunction in any part of the system, it turns on the AIRBAG warning light either

momentarily or continuously. A single chime will sound if the light comes on again after initial start up.

WARNING!

Ignoring the AIRBAG light in your instrument panel could mean you won't have the airbags to protect you in a collision. If the light does not come on, stays on after you start the vehicle, or if it comes on as you drive, have the airbag system checked right away.

- The **Occupant Classification System (OCS)** is part of a Federally regulated safety system required for this vehicle. It is designed to turn off the front passenger airbag for occupants that weigh less than a very small adult.

NOTE: Children 12 years and under should always ride buckled up in a rear seat in an appropriate child restraint.

- The OCS classifies an occupant using weight sensors mounted in the base of the front passenger seat. Any weight on the seat will be sensed by the system. Objects hanging on the seat or other passengers pushing down on the seat will also be sensed. The weight of an adult will cause the system to turn the airbag on. In this case, the OCS has classified the occupant of the seat as an adult. An adult occupant needs to sit in a normal position (with their feet on or near the floor) in order to be properly classified. Reclining the seat back too far may change how an occupant is classified by the OCS.
- The **Passenger Airbag Disable (PAD) Indicator Light** (an amber light located in the center of the instrument panel) tells the driver and front passenger when the front passenger airbag is turned off. The PAD Indicator lamp illuminates the words "PASS AIR BAG OFF" to show that the front passenger airbag will not inflate during a collision requiring airbags. When the right

front passenger seat is empty or when very light objects are placed on the seat, the passenger air bag will not inflate even though the Passenger Airbag Disable (PAD) indicator lamp is not illuminated.

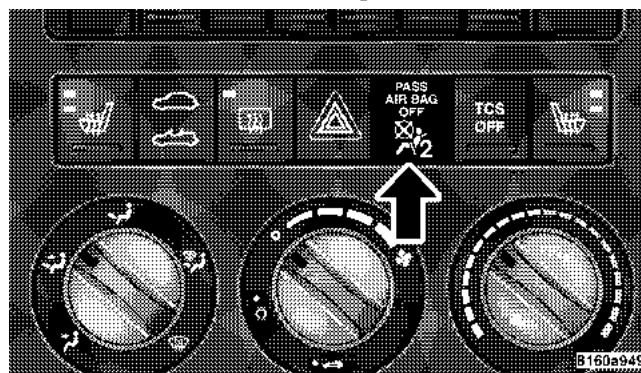

Passenger Airbag Disabled Light

The PAD indicator light should not be illuminated when teenagers, most children in a forward facing

child restraint or booster seats, most children that can properly wear the vehicle’s seat belt, and when an adult passenger is properly seated in the front passenger seat. In this case, the air bag is ready to be inflated if a collision requiring an airbag occurs.

For all other occupants, the PAD indicator light will be illuminated indicating that the front passenger airbag is turned off and will not inflate.

NOTE: Even though this vehicle is equipped with an occupant classification system, children 12 years and under should always ride buckled up in a rear seat in an appropriate child restraint (see section on child restraints).

WARNING!

Never place a rear facing infant seat in front of an airbag. A deploying passenger airbag can cause death or serious injury to a child in a rear facing infant seat.

Front Passenger Seat Occupant	Passenger Airbag Disable (PAD) Indicator Light	Airbag Status
Adult	OFF	ON
Child	ON	OFF
Grocery Bags, Heavy Briefcases and Other Relatively Light Objects	ON	OFF
Empty or Very Small Objects	OFF*	OFF
* Since the system senses weight, some small objects will turn the PAD Indicator Light on.		

Drivers and adult passengers should verify that the PAD Indicator Light is not illuminated when an adult is riding in the front passenger seat. If an adult occupant’s weight is transferred to another part of the vehicle (like the door

or instrument panel), the weight sensors in the seat may not properly classify the occupant. Objects lodged under the seat or between the seat and the center console can prevent the occupant's weight from being measured properly and may result in the occupant being improperly classified. Ensure that the front passenger seat back does not touch anything placed on the second row of seats because this can also affect occupant classification. Also, if you fold down the seats in the second row check to be sure they don't touch the front passenger seat.

If the front passenger seat is damaged in any way, it should only be serviced by an authorized dealer. If the seat is removed (or even if the seat attachment bolts are loosened or tightened in any way), take the vehicle to an authorized dealer.

If there is a fault present in the OCS, the Airbag Warning Light (a red light located in the center of the instrument cluster directly in front of the driver) will be turned on.

This indicates that you should take the vehicle to an authorized dealer. The Airbag Warning Light is turned on whenever there is a fault that can affect the operation of the airbag system. If there is a fault present in the OCS, both the PAD Indicator Light and the Airbag Warning Light are illuminated to show that the passenger airbag is turned off until the fault is cleared. If an object is lodged under the seat and interferes with operation of the weight sensors, a fault will occur which turns on both the PAD Indicator Light and the Airbag Warning Light. Once the lodged object is removed, the fault will be automatically cleared after a short period of time.

- The **Driver and Passenger Airbag/Inflator Units** are located in the center of the steering wheel and the right side of the instrument panel. When the ORC detects a collision requiring the airbags, it signals the inflator units. A large quantity of nontoxic gas is generated to inflate the front airbags. Different airbag inflation rates

may be possible based on collision severity and occupant size. The steering wheel hub trim cover and the upper right side of the instrument panel separate and fold out of the way as the bags inflate to their full size. The bags fully inflate in about 50 - 70 milliseconds. This is about half of the time it takes to blink your eyes. The bags then quickly deflate while helping to restrain the driver and front passenger. The driver's front airbag gas is vented through vent holes in the sides of the airbag. The passenger's front airbag gas is vented through vent holes in the sides of the airbag. In this way the airbags do not interfere with your control of the vehicle.

- The **Occupant Classification Module (OCM)** is located beneath the front passenger seat. The OCM classifies the occupant into categories based on the measurements made by the seat weight sensors. The OCM communicates with the Occupant Restraint Controller (ORC). The ORC uses the occupant category to

determine whether the front passenger airbag should be turned off. It also determines the rate of airbag inflation during a collision.

- Your vehicle has four **Weight Sensors** located between the seat and the floor pan. The weight sensors measure applied weight and transfers that information to the OCM.
- The **Side Impact (SRS) Seat Mounted Side Airbags (If equipped)** are designed to activate only in certain side collisions. The ORC module determines if a side collision is severe enough to require the side airbags to inflate. The side airbag control module will not detect roll over, front or rear collisions.

The ORC Module monitors the readiness of the electronic parts of the system whenever the ignition switch is in the START or ON positions. These include all of the items previously mentioned.

In moderate to severe side collisions, the side airbag inflator on the crash side of the vehicle is triggered, releasing a quantity of nontoxic gas. The inflating side airbag exits through the seat seam into the space between the occupant and the door. The side airbag moves at a very high speed and with such a high force, that it could injure you if you are not seated properly, or if items are positioned in the area where the side airbag inflates. This especially applies to children.

- When the ORC and the impact sensors detect a collision requiring the **Driver Inflatable Knee Blocker**, it signals the inflator unit. A quantity of nontoxic gas is generated to inflate the Driver Inflatable Knee Blocker. The Driver Inflatable Knee Blocker inflates rearward towards the driver's knees to help protect the knees and position you for the best interaction with the front airbag. The Driver Inflatable Knee Blocker fully inflates in about 50 milliseconds,

this is only about half of the time it takes you to blink your eyes. It then quickly deflates while helping to protect the driver's knees.

- The **Knee Impact Bolsters** help protect the knees, and position everyone for the best interaction with the front airbag.

The front passenger seat assembly contains critical components that affect the front passenger airbag deployment. Correctly functioning front passenger seat components are critical for the Occupant Classification System (OCS) to properly classify the front passenger and calculate the proper airbag deployment. Do not make any modifications to the front passenger seat components, assembly, or to the seat cover.

The following requirements must be strictly adhered to:

- Do not modify the front passenger seat assembly or components in any way.

- Do not modify the front seat center console or center position seat in any way.
- Do not use prior or future model year seat covers not designated for the specific model being repaired. Always use the correct seat cover specified for the vehicle.
- Do not replace the seat cover with an aftermarket seat cover.
- Do not add a secondary seat cover other than those approved by DaimlerChrysler/Mopar.
- At no time should any supplemental restraint system (SRS) component or SRS related component or fastener be modified or replaced with any part except those which are approved by DaimlerChrysler/Mopar.

WARNING!

Unapproved modifications or service procedures to the front passenger seat assembly, its related components, or seat cover may inadvertently change the airbag deployment in case of a frontal crash. This could result in death or serious injury to the front seat passenger if the vehicle is involved in an accident. A modified vehicle may not comply with required Federal Motor Vehicle Safety Standards (FMVSS).

If A Deployment Occurs

The airbag systems are designed to deploy when the airbag control modules detect a moderate-to-severe collision, to help restrain the driver and front passenger, and then immediately deflate.

NOTE: A frontal collision that is not severe enough to need airbag protection will not activate the system. This does not mean something is wrong with the airbag system.

If you do have a collision which deploys the airbags, any or all of the following may occur:

- The nylon airbag material may sometimes cause abrasions and/or skin reddening to the driver and front passenger as the airbags deploy and unfold. The abrasions are similar to friction rope burns or those you might get sliding along a carpet or gymnasium floor. They are not caused by contact with chemicals. They are not permanent and normally heal quickly. However, if you haven't healed significantly within a few days, or if you have any blistering, see your doctor immediately. As the airbags deflate you may see some smoke-like particles. The particles are a normal by-product of the process that generates the nontoxic gas used for airbag inflation. These airborne particles may

irritate the skin, eyes, nose, or throat. If you have skin or eye irritation, rinse the area with cool water. For nose or throat irritation, move to fresh air. If the irritation continues, see your doctor. If these particles settle on your clothing, follow the garment manufacturer's instructions for cleaning.

- It is not advisable to drive your vehicle after the airbags have deployed. If you are involved in another collision, the airbags will not be in place to protect you.

WARNING!

Deployed airbags and seat belt pretensioners cannot protect you in another collision. Have the airbags, seat belt pretensioners, and the front passenger seat belt retractor assembly, replaced by an authorized dealer as soon as possible. Also, have the Occupant Classification System serviced as well.

Maintaining Your Airbag System

WARNING!

- Modifications to any part of the airbag system could cause it to fail when you need it. You could be injured if the airbag system is not there to protect you. Do not modify the components or wiring, including adding any kind of badges or stickers to the steering wheel hub trim cover or the upper right side of the instrument panel. Do not modify the front bumper, vehicle body structure, or add aftermarket side steps or running boards.
- Do not attempt to modify any part of your advanced airbag system. The airbag may inflate accidentally or may not function properly if modifications are made. Take your vehicle to an authorized dealer for any advanced airbag system service. If your seat including your trim cover and cushion needs to be serviced in any way (including removal or loosening/tightening of seat attachment bolts), take the vehicle to your authorized dealer. Only manufacturer approved seat accessories may be used. If it is necessary to modify an advanced airbag system for persons with disabilities, contact your authorized dealer.
- Do not place or hang any items such as add-on video players on the right front passenger seat back. The additional weight may cause the Occupant Classification System to be unable to correctly classify the right front occupant. This could allow the passenger frontal airbag to inflate when it is not desired.
- You need proper knee impact protection in a collision. Do not mount or locate any aftermarket equipment on or behind the knee bolsters/ driver inflatable knee blocker.
- It is dangerous to try to repair any part of the airbag system yourself. Be sure to tell anyone who works on your vehicle that it has an airbag system.

Airbag Light

You will want to have the airbags ready to inflate for your protection in a collision. While the airbag system is designed to be maintenance free, if any of the following occurs, have an authorized dealer service the system immediately.

- The AIRBAG light does not come on during the 6 to 8 seconds when the ignition switch is first turned on.
- The light remains on after the 6 to 8 second interval.
- The light comes on and remains on while driving.

Event Data Recorder (EDR)

In the event of an airbag deployment, your vehicle is designed to record up to 2-seconds of specific vehicle data parameters (see list below) in an event data recorder prior to the moment of airbag deployment. Please note that such data are ONLY recorded if an airbag deploys, and are otherwise unavailable. In conjunction with other

data gathered during a complete accident investigation, the electronic data may be used by DaimlerChrysler and others to learn more about the possible causes of crashes and associated injuries in order to assess and improve vehicle performance. In addition to crash investigations initiated by DaimlerChrysler, such investigations may be requested by customers, insurance carriers, government officials, and professional crash researchers, such as those associated with universities, and with hospital and insurance organizations.

In the event that an investigation is undertaken by DaimlerChrysler (regardless of initiative), the company or its designated representative will first obtain permission of the appropriate custodial entity for the vehicle (usually the vehicle owner or lessee) before accessing the electronic data stored, unless ordered to download data by a court with legal jurisdiction (i.e., pursuant to a warrant). A copy of the data will be provided to the custodial entity upon request. General data that does not

identify particular vehicles or crashes may be released for incorporation in aggregate crash databases, such as those maintained by the US government and various states. Data of a potentially sensitive nature, such as would identify a particular driver, vehicle, or crash, will be treated confidentially. Confidential data will not be disclosed by DaimlerChrysler to any third party except when:

1. Used for research purposes, such as to match data with a particular crash record in an aggregate database, provided confidentiality of personal data is thereafter preserved
2. Used in defense of litigation involving a DaimlerChrysler product
3. Requested by police under a legal warrant
4. Otherwise required by law

Data Parameters that May Be Recorded:

- Diagnostic trouble code(s) and warning lamp status for electronically-controlled safety systems, including the airbag system
- Airbag disable lamp status (if equipped)
- "Time" of airbag deployment (in terms of ignition cycles and vehicle mileage)
- Airbag deployment level (if applicable)
- Seatbelt status
- Brake status (service and parking brakes)
- Accelerator status (including vehicle speed)
- Engine control status (including engine speed)
- Cruise control status
- Traction/stability control status

Child Restraint

Everyone in your vehicle needs to be buckled up at all times — babies and children, too. Every state in the United States and all Canadian provinces require that small children ride in proper restraint systems. This is the law, and you can be prosecuted for ignoring it.

Children 12 years and under should ride properly buckled up in a rear seat, if available. According to crash statistics, children are safer when properly restrained in the rear seats, rather than in the front.

WARNING!

In a collision, an unrestrained child, even a tiny baby, can become a missile inside the vehicle. The force required to hold even an infant on your lap could become so great that you could not hold the child, no matter how strong you are. The child and others could be badly injured. Any child riding in your vehicle should be in a proper restraint for the child's size.

Infants And Small Children

There are different sizes and types of restraints for children from newborn size to the child almost large enough for an adult safety belt. Always check the child seat owner's manual to ensure you have the correct seat for your child. Use the restraint that is correct for your child:

- Safety experts recommend that children ride rearward-facing in the vehicle until they are at least one year old and weigh at least 20 lbs (9 kg). Two types of child restraints can be used rearward-facing: infant carriers and "convertible" child seats. Both types of child restraints are held in the vehicle by the lap/shoulder belt or the LATCH child restraint anchorage system.
- The infant carrier is only used rearward-facing in the vehicle. It is recommended for children who weigh up to about 20 lbs (9 kg). "Convertible" child seats can be used either rearward-facing or forward-facing in the vehicle. Convertible child seats often have a higher weight limit in the rearward-facing direction than infant carriers do, so they can be used rearward-facing by children who weigh more than 9 kg (20 lbs) but are less than one year old.

- Rearward-facing child seats must **NEVER** be used in the front seat of a vehicle with a front passenger airbag. An airbag deployment could cause severe injury or death to infants in this position.
- Children who weigh more than 20 lbs (9 kg) and who are older than one year can ride forward-facing in the vehicle. Forward-facing child seats and convertible child seats used in the forward-facing direction are for children who weigh 20 to 40 lbs (9 to 18 kg) and who are older than one year. These child seats are also held in the vehicle by the lap/shoulder belt or the LATCH child restraint anchorage system.
- The belt-positioning booster seat is for children weighing more than 40 lbs (18 kg), but who are still too small to fit the vehicle's seat belts properly. If the child cannot sit with knees bent over the vehicle's cushion while the child's back is against the seat back; they should use a Belt Positioning Booster Seat. The child and booster seat

are held in the vehicle by the lap/shoulder belt. (Some booster seats are equipped with a front shield and are held in the vehicle by the lap portion.)

NOTE: For additional information refer to www.nhtsa.dot.gov or www.seatcheck.org.

WARNING!
<ul style="list-style-type: none"> • Improper installation can lead to failure of an infant or child restraint. It could come loose in a collision. The child could be badly injured or killed. Follow the manufacturer's directions exactly when installing an infant or child restraint. • A rearward facing child restraint should only be used in a rear seat. A rearward facing child restraint in the front seat may be struck by a deploying passenger airbag which may cause severe or fatal injury to the infant.

Here are some tips on getting the most out of your child restraint:

- Before buying any restraint system, make sure that it has a label certifying that it meets all applicable Safety Standards. We also recommend that you make sure that you can install the child restraint in the vehicle where you will use it, before you buy it.
- The restraint must be appropriate for your child's weight and height. Check the label on the restraint for weight and height limits.
- Carefully follow the instructions that come with the restraint. If you install the restraint improperly, it may not work when you need it.

The passenger seat belts are equipped with seat belt retractors that can be switched to an automatic locking mode, which are designed to keep the lap portion tight around the child restraint so that it is not necessary to use a locking clip.

Pull the belt from the retractor until there is enough to allow you to pass through the child restraint and slide the latch plate into the buckle. Then pull on the belt until it is all removed from the retractor. Allow the belt to return into the retractor, as the belt retracts, you will hear a clicking sound. This indicates that the seat belt is now in the automatic locking mode. Pull on the excess webbing to tighten the lap portion about the child restraint. Follow the instructions of the child restraint manufacture.

NOTE: To reset this feature you must let all of the belt webbing return into the retractor. You will not be able to pull out more webbing until all of the webbing has been returned back into the retractor.

- In the rear seat, you may have trouble tightening the lap/shoulder belt on the child restraint because the buckle or latch plate is too close to the belt path opening on the restraint. Disconnect the latch plate from the buckle and twist the short buckle end of the

belt several times to shorten it. Insert the latch plate into the buckle with the release button facing out.

- If the belt still can't be tightened, or if by pulling and pushing on the restraint loosens the belt, disconnect the latch plate from the buckle, turn the latch plate around, and insert the latch plate into the buckle again. If you still can't make the child restraint secure, try a different seating position.
- Buckle the child into the seat according to the child restraint manufacturer's directions.
- When your child restraint is not in use, secure it in the vehicle with the seat belt or remove it from the vehicle. Don't leave it loose in the vehicle. In a sudden stop or collision, it could strike the occupants or seat backs and cause serious personal injury.

Lower Anchors and Tether for Children (LATCH)

Your vehicle is equipped with the child restraint anchorage system called LATCH, which stands for Lower Anchors and Tether for Children. The LATCH system provides for the installation of the child restraint without using the vehicle seat belt. Both rear seating positions have exclusive lower anchorages located at the rear of the seat cushion. They are round bars, part of the seat and body structure, and are readily visible. In addition, there are two tether strap anchorages located behind the rear seat head form, in the convertible top storage area.

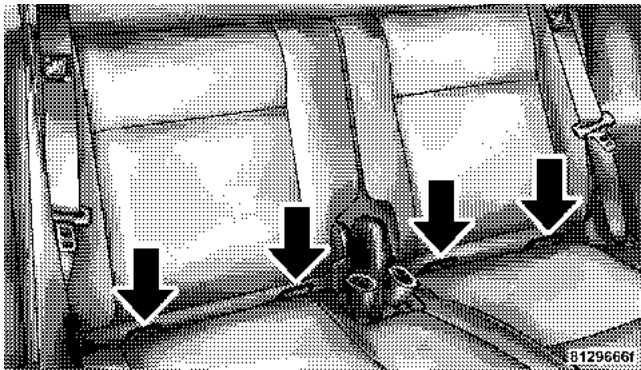

Latch Anchors

Child restraints systems having attachments designed to connect to the lower anchorages are now available. Child restraints having tether straps and hooks for connection to the top tether anchorage have been available for some time. In fact, many child restraint manufacturers will

provide add-on tether strap kits for some of their older products. Tether anchorage kits are also available for most older vehicles.

Because the lower anchorages are to be introduced to passenger carrying vehicles over a period of years, child restraint systems having attachments for those anchorages will continue to have features for installation in vehicles using the lap or lap/shoulder belt. They will also have tether straps, and you are urged to take advantage of all of the available attachments provided with your child restraint in any vehicle.

NOTE: When using the LATCH attaching system to install a child restraint, please ensure that all seat belts not being used for occupant restraints are stowed and out of reach of children. It is recommended that before installing the child restraint, buckle the seat belt so the seat belt is tucked behind the child restraint and out of reach. If the buckled seat belt interferes with the child

restraint installation, instead of tucking the seat belt behind the child restraint, route the seat belt through the child restraint belt path and then buckle it. This should stow the seat belt out of the reach of an inquisitive child. Remind all children in the vehicle that the seat belts are not toys and should not be played with, and never leave your child unattended in the vehicle.

Installing the Child Restraint System

We urge that you carefully follow the directions of the manufacturer when installing your child restraint. Many, but not all, restraint systems will be equipped with separate straps on each side, with each having a hook or connector and a means for adjusting the tension in the strap. Forward-facing toddler restraints and some rearward-facing infant restraints will also be equipped with a tether strap with a hook and means for adjusting the tension in the strap.

In general, you will first loosen the adjusters on the lower and tether straps so that you can more easily attach the hook or connector to the lower and tether anchorages. The tether strap should be routed over the center of the head form and attached to the tether anchor, located behind the rear seat head form, in the convertible top storage area. Then tighten all three straps as you push the child restraint rearward and downward into the seat.

NOTE: To gain access to the anchorages, locate the child tether anchorage decals on the carpet behind the rear seat head forms and use a small screwdriver to pry the carpet flap open. The carpet flap is attached in two different places.

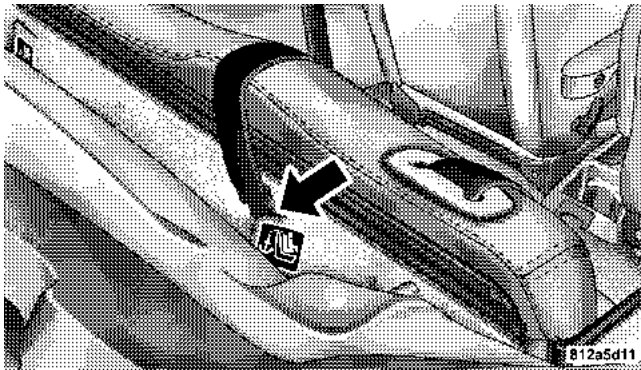

Tether Strap Mounting

Not all child restraint systems will be installed as we have described here. Again, carefully follow the instructions that come with the child restraint system.

NOTE: If your child restraint seat is not LATCH compatible, install the restraint using the vehicle seat belts.

WARNING!

An incorrectly anchored tether strap could lead to increased head motion and possible injury to the child. Use only the anchor position directly behind the child seat to secure a child restraint top tether strap.

Children Too Large For Booster Seats

Children who are large enough to wear the shoulder belt comfortably, and whose legs are long enough to bend over the front of the seat when their back is against the seat back, should use the lap/shoulder belt in a rear seat.

- Make sure that the child is upright in the seat.
- The lap portion should be low on the hips and as snug as possible.

- Check belt fit periodically. A child's squirming or slouching can move the belt out of position.
- If the shoulder belt contacts the face or neck, move the child closer to the center of the vehicle. Never allow a child to put the shoulder belt under an arm or behind their back.

Transporting Pets

Airbags deploying in the front seat could harm your pet. An unrestrained pet will be thrown about and possibly injured, or injure a passenger during panic braking or in a collision.

Pets should be restrained in the rear seat in pet harnesses or pet carriers that are secured by seat belts.

ENGINE BREAK-IN RECOMMENDATIONS

A long break-in period is not required for the engine in your new vehicle.

Drive moderately during the first 300 miles (500 km). After the initial 60 miles (100 km), speeds up to 50 or 55 mph (80 or 90 km/h) are desirable.

While cruising, brief full-throttle acceleration, within the limits of local traffic laws, contributes to a good break-in. Wide open throttle acceleration in low gear can be detrimental and should be avoided.

The engine oil installed in the engine at the factory is a high quality energy conserving type lubricant. Oil changes should be consistent with anticipated climate conditions under which vehicle operations will occur. The recommended viscosity and quality grades are shown in Section 7 of this manual. **NON-DETERGENT OR STRAIGHT MINERAL OILS MUST NEVER BE USED.**

A new engine may consume some oil during its first few thousand miles (kilometers) of operation. This should be considered as a normal part of the break-in and not interpreted as an indication of difficulty.

SAFETY TIPS

Exhaust Gas

WARNING!
Exhaust gases can injure or kill. They contain carbon monoxide (CO) which is colorless and odorless. Breathing it can make you unconscious and can eventually poison you. To avoid breathing (CO) follow the safety tips below.

Do not run the engine in a closed garage or in confined areas any longer than needed to move your vehicle in or out of the area.

If it is necessary to sit in a parked vehicle with the engine running, adjust your heating or cooling controls to force outside air into the vehicle. Set the blower at high speed.

WARNING!
If you are required to drive with the deck lid/liftgate open, make sure that all windows are closed, and the climate control blower switch is set at high speed. DO NOT use the recirculation mode.

Safety Checks You Should Make Inside The Vehicle

Seat Belts

Inspect the belt system periodically, checking for cuts, frays and loose parts. Damaged parts must be replaced immediately. Do not disassemble or modify the system.

Front seat belt assemblies must be replaced after a collision. Rear seat belt assemblies must be replaced after a collision if they have been damaged (bent retractor, torn webbing, etc. If there is any question regarding belt or retractor condition, replace the belt.

Airbag Light

The light should come on and remain on for 6 to 8 seconds as a bulb check when the ignition switch is first turned ON. If the LED is not lit during starting, have it checked. If the light stays on or comes on while driving, have the system checked by an authorized dealer.

Defroster

Check operation by selecting the defrost mode and place the blower control on high speed. You should be able to feel the air directed against the windshield.

Periodic Safety Checks You Should Make Outside The Vehicle**Tires**

Examine tires for excessive tread wear or uneven wear patterns. Check for stones, nails, glass, or other objects lodged in the tread. Inspect tread and sidewall for cuts or cracks. Check wheel nuts for tightness, and tires (including spare) for proper pressure.

Lights

Have someone observe the operation of exterior lights while you work the controls. Check turn signal and high beam indicator lights on the instrument panel.

Fluid Leaks

Check area under vehicle after overnight parking for fuel, engine coolant, oil or other fluid leaks. Also, if gasoline fumes are detected or fuel, power steering fluid or brake fluid leaks are suspected, the cause should be located and corrected immediately.

UNDERSTANDING THE FEATURES OF YOUR VEHICLE

CONTENTS

■ Convertible Top Operation	121	□ Outside Mirror—Driver’s Side	134
□ To Lower The Top	121	□ Outside Mirror—Passenger’s Side	134
□ To Raise The Top	124	□ Electric Remote-Control Mirrors — If Equipped	135
□ Convertible Top Boot Cover Installation—If Equipped	126	□ Illuminated Vanity Mirrors — If Equipped	135
□ Convertible Top Boot Cover Removal And Storage	130	□ Sun Visor Sliding Feature	136
□ Convertible Top Manual Override	132	■ Hands-Free Communication (UConnect™) — If Equipped	136
■ Mirrors	133	□ Operations	138
□ Inside Day/Night Mirror — If Equipped	133	□ Phone Call Features	145

118 UNDERSTANDING THE FEATURES OF YOUR VEHICLE

□ UConnect™ System Features	147	□ Folding Rear Seat (Sedan)	166
□ Advanced Phone Connectivity	152	□ Folding Rear Seat (Convertible)	168
□ Things You Should Know About Your UConnect™ System	154	□ Tumbling Rear Seat (Sedan)	169
■ Seats	159	□ Tumbling Rear Seat (Convertible)	171
□ Front Seat Adjustment	159	□ Rear Seat Removal (Sedan)	175
□ Power Seat Adjuster — If Equipped	160	■ To Open And Close The Hood	177
□ Manual Lumbar—If Equipped	162	■ Lights	178
□ Folding Front Passenger Seat — If Equipped . .	162	□ Map/Reading Lights (Sedan)	178
□ Driver’s Seat Back Tilt—If Equipped	163	□ Map/Reading Lights (Convertible)	179
□ Passenger Seat Back Tilt (Easy Entry System) (Convertible)	163	□ Interior Lights	180
□ Adjustable Head Restraints	164	□ Multi-Function Control Lever	181
□ Heated Seats — If Equipped	165	□ Headlights, Parking Lights, Instrument Panel Lights	182

<hr/>		UNDERSTANDING THE FEATURES OF YOUR VEHICLE 119
<input type="checkbox"/> Daytime Running Lights (DRL)(Canada Only) .182	<input type="checkbox"/> Lights-On Reminder182	<input type="checkbox"/> Fog Lights — If Equipped183
<input type="checkbox"/> Turn Signals183	<input type="checkbox"/> Highbeam/Lowbeam Select Switch183	<input type="checkbox"/> Passing Light183
<input checked="" type="checkbox"/> Windshield Wipers And Washers184	<input type="checkbox"/> Windshield Washers184	<input type="checkbox"/> Mist Feature184
<input type="checkbox"/> Windshield Wiper Operation185	<input type="checkbox"/> Intermittent Wiper System185	<input type="checkbox"/> Rear Window Wiper/Washer (Sedan Models Only)186
<input checked="" type="checkbox"/> Tilt Steering Column187	<input checked="" type="checkbox"/> Traction Control Switch — If Equipped188	<input checked="" type="checkbox"/> Electronic Speed Control — If Equipped189
	<input type="checkbox"/> To Activate189	<input type="checkbox"/> To Set At A Desired Speed190
	<input type="checkbox"/> To Deactivate190	<input type="checkbox"/> To Resume Speed190
	<input type="checkbox"/> To Vary The Speed Setting190	<input type="checkbox"/> Manual Transaxle191
	<input type="checkbox"/> To Accelerate For Passing191	<input checked="" type="checkbox"/> Garage Door Opener — If Equipped192
	<input type="checkbox"/> Programming The Universal Transceiver194	<input type="checkbox"/> “Rolling Code” Programming196

120 UNDERSTANDING THE FEATURES OF YOUR VEHICLE

□ Canadian Programming/Gate Programming . . .197	■ Storage205
□ Operation198	□ Center Console/Armrest Storage Bin205
□ Reprogramming A Single Button198	□ Storage Pockets207
□ Security198	■ Rear Shelf Panel— If Equipped207
■ Power Sunroof — If Equipped199	□ Position 1 (Top)208
□ Express Open Feature200	□ Position 2 (Middle)209
□ Wind Buffeting201	□ Position 3 (Floor)209
□ Sunroof Maintenance201	□ Position 4 (Vertical)210
■ Electrical Power Outlets201	□ Position 5 (Table)210
□ Electrical Outlet Use With Engine Off204	■ Roof Luggage Rack — If Equipped212
■ Console Features204	

CONVERTIBLE TOP OPERATION**WARNING!**

The convertible top does not provide the structural protection that a reinforced metal roof does, and the fabric top cannot be expected to prevent the ejection of the occupants of a vehicle in a collision. Therefore it is important that all occupants wear their seat belts at all times when riding in a convertible. Studies have shown that it is generally safer to remain inside a vehicle during a collision, than to be ejected from the vehicle.

To Lower The Top:

NOTE: Thoroughly dry the convertible top and top storage area, prior to leaving the top lowered for an extended period of time. This will help prevent possible mildew build-up.

CAUTION!

To avoid damage to the convertible top or its components, your vehicle is equipped with a feature that prevents convertible top operation at speeds over 10 mph (16 km/h).

CAUTION!

To fully insure that no damage occurs, be sure that the vehicle is at a complete stop with the gear selector in the Park position (automatic transaxle) or in the Neutral position (manual transaxle) before lowering or raising the top.

CAUTION!

Do not operate the convertible top with ice or snow build-up on the top. Damage to the top may occur.

CAUTION!

To avoid damage to either the top or the rear window, check the top storage area at the rear of the vehicle interior to be sure that it is clear of debris or other items. Be sure that child seat flip up bars are lowered. Do not use the top storage area for other storage purposes.

NOTE: When closing the convertible top all windows will drop slightly from the full up position.

1. Turn the ignition key to the ON position.
2. Release the top from the windshield header by pulling down on the latch handle and turning the latch handle clockwise until it stops.

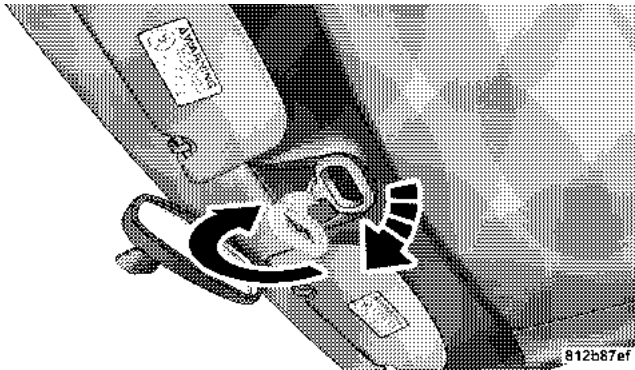

Releasing Convertible Top Latches

3. Press the Power Top Switch to lower the top just enough to disengage the top pins from the header, turn the handle counterclockwise and raise the handle to the stowed position.

NOTE: The Power Top Switch has two detent positions for lowering the convertible top. Pressing and holding

the Power Top Switch lightly in the first detent position will lower the windows slightly and the convertible top to the full down position. Pressing and holding the switch in the second detent position will lower all four windows completely and the top to the full down position.



Convertible Top Switch

4. Continue pressing the Power Top Switch until the convertible top is lowered completely.
5. Install the Convertible Top Boot Cover, if equipped. Refer to Convertible Top Boot Cover Installation–If Equipped, in this section.

CAUTION!

Damage to the convertible top boot cover could result if the latch handle is not completely closed when the top is lowered. The convertible top boot cover cannot be installed while the latch handle is open.

To Raise The Top:

CAUTION!

To avoid damage to the convertible top or its components, your vehicle is equipped with a feature that prevents convertible top operation at speeds over 10 mph (16 km/h).

CAUTION!

To fully insure that no damage occurs, be sure that the vehicle is at a complete stop with the gear selector in the Park position (automatic transaxle) or in the Neutral position (manual transaxle) before lowering or raising the top.

1. Remove the convertible top boot cover, if equipped. Refer to Convertible Top Boot Cover Removal and Storage, in this section.
2. Turn the ignition to the ON position.
3. Press the Power Top Switch to raise the top. Before the top reaches the windshield, open the latch handle and turn the handle clockwise to open the latches. Press the switch again to continue raising the top until the two pins seat themselves in the windshield header.

NOTE: If the top is not latched right away, it may be necessary to press the power top switch, "UP" or "DOWN" quickly, to align the pins to the windshield header.

4. Pull down on the latch handle and rotate it counter-clockwise to engage the latches.

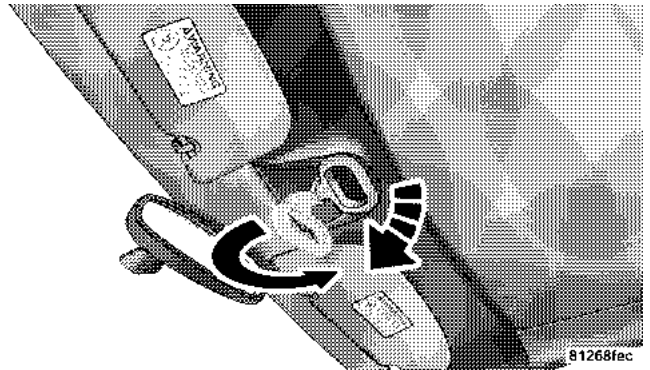

Engaging Convertible Top Latches

5. Raise the latch handle into the stowed position.

CAUTION!

Car top carriers, ski racks, etc., should not be attached to the convertible top mechanism as they will damage the top. Do not place objects on the convertible top, in the top well or on the sport bar. Damage to the convertible top may occur.

Convertible Top Boot Cover Installation–If Equipped

1. With the top down and the convertible top latch handle in the stowed position, lay the unfolded boot cover across the convertible top.

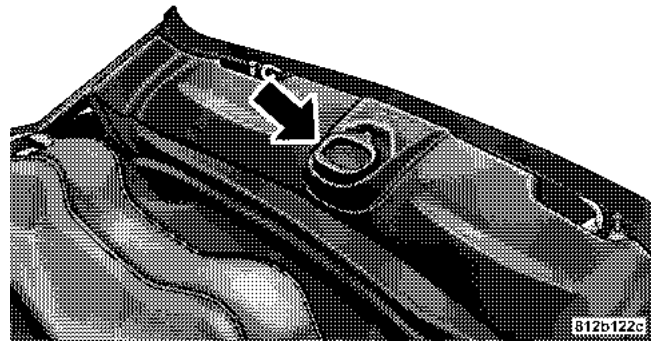

Convertible Top Latch Handle

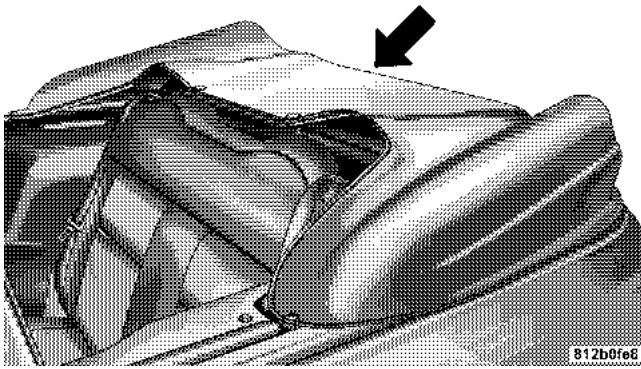

Boot Laying Across Convertible Top

2. Install the rear edge of the boot, first tucking the rear edge of the boot under the rear and both sides of the rails.

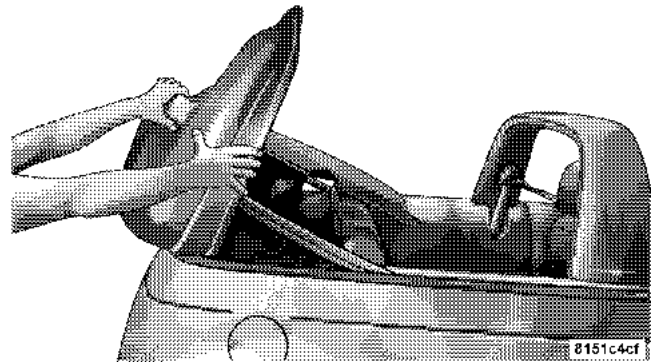

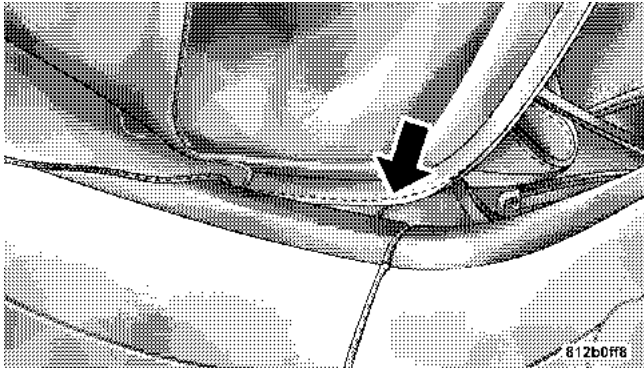

Tucking Boot Under Rail

3. Pull the right and left boot arms forward and engage both boot arm snaps. Make sure both snaps are fully engaged.

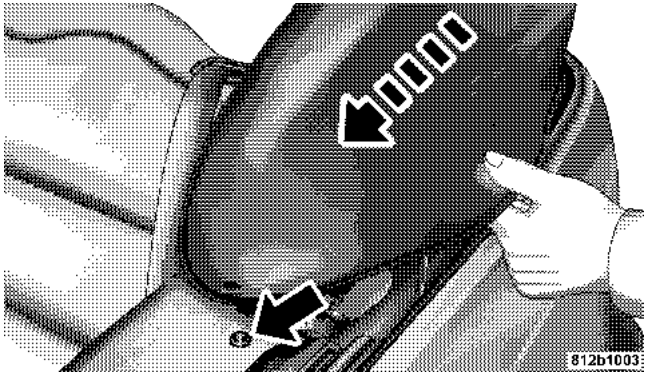

Engaging Boot Arm Snaps

4. Engage the boot center section retainer using the tabs provided.

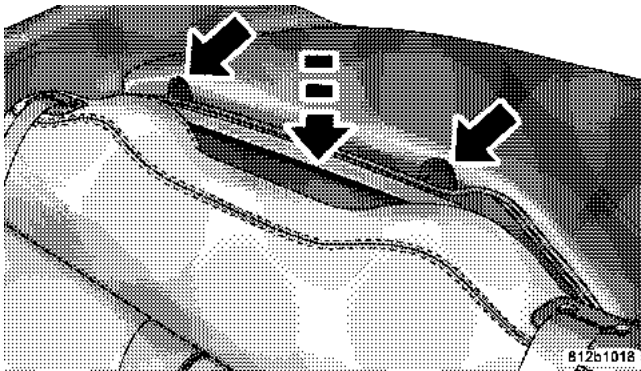

Engaging Boot Center Section

5. Tuck the rear flap of the boot in behind the Upper Moulding.

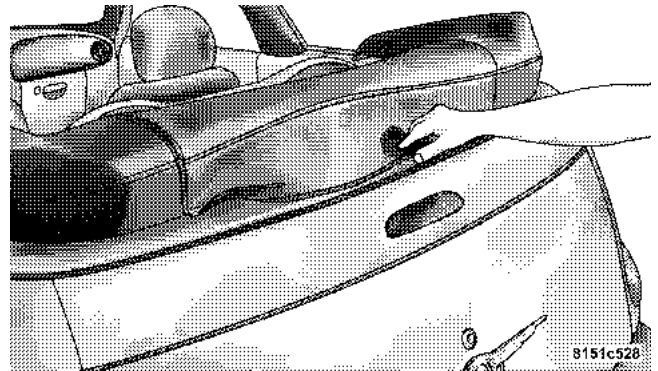

Tucking In Rear Flap

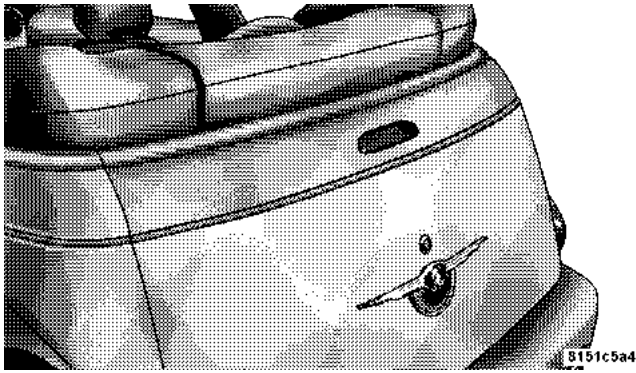

Convertible Top Boot Cover Removal and Storage

1. Unsnap the snaps and remove the top cover boot.
2. Lay the boot cover flat with the center section retainer facing the rear of the car.

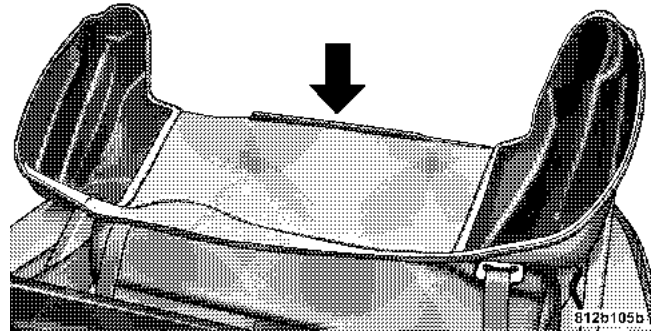

Boot Removed And Laying Flat

3. First fold the left side of the boot cover to the middle of the boot cover.

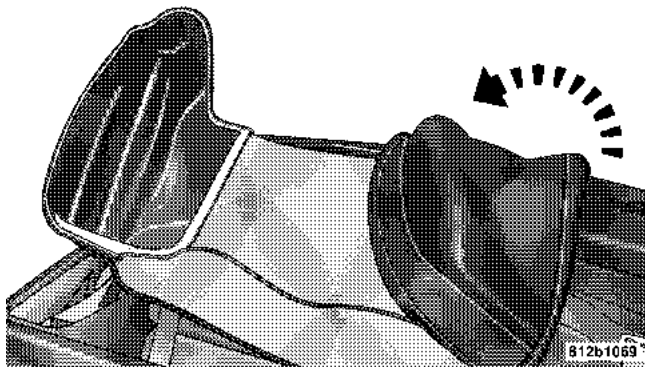

Folding Boot Cover Left Side

4. Second fold the right side of the boot cover to the middle, fitting it inside the left side of the boot cover and store it in the trunk or a dry secure area.

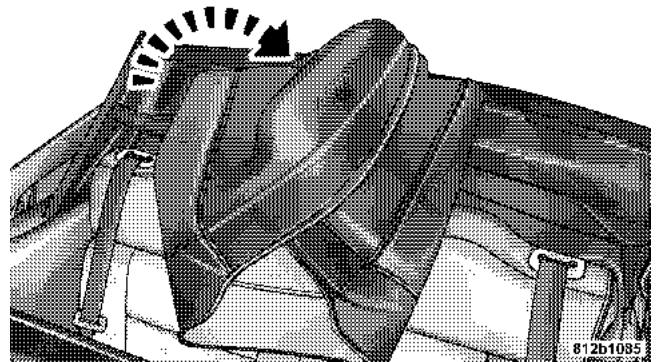

Folding Boot Cover Right Side

3

CAUTION!

Do not lay heavy objects on top of the boot or lay the boot on top of sharp/pointy objects. Damage could occur to the boot.

CONVERTIBLE TOP MANUAL OVERRIDE

If your vehicle is experiencing electrical failure (low battery, etc.) and it is necessary to raise the convertible top, perform the following steps:

1. Locate the convertible top motor bypass screw, which is found in the trunk under the convertible top storage area.
2. Turn the screw counterclockwise until the screw stops. This will relieve the hydraulic pressure and allow the convertible top to be raised manually.

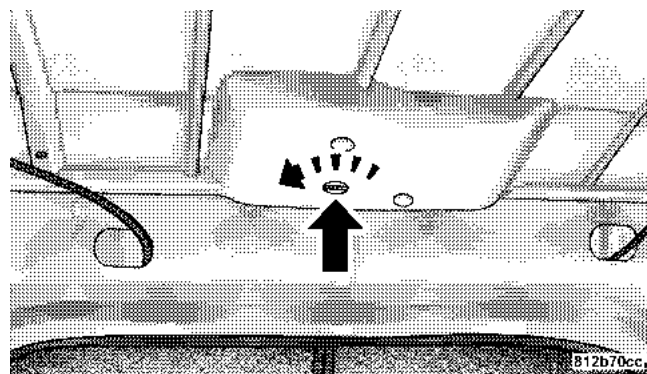

Bleeder Screw

3. Using the latch handle raise the top until the two pins seat themselves in the windshield header.
4. Rotate the latch handle clockwise to open the latches.
5. Pull down and rotate the handle counterclockwise to engage the latches.

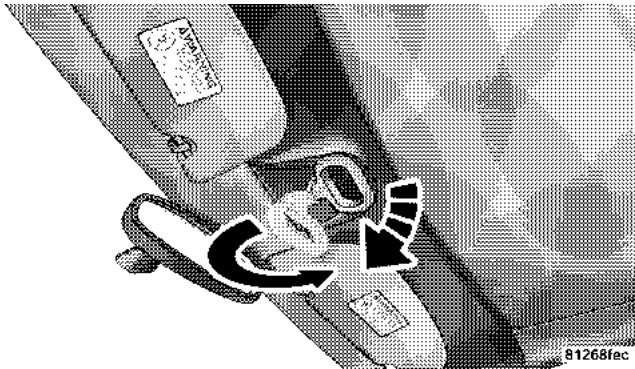

Engaging Convertible Top Latches

6. Raise the handle into the stowed position.
7. Close the convertible top motor bypass screw by turning the screw clockwise until it stops. Tighten the screw securely.

NOTE: Failure to tighten the bypass screw securely can cause convertible top operating concerns.

MIRRORS

Inside Day/Night Mirror — If Equipped

Adjust the mirror to center on the view through the rear window. A two point pivot system allows for horizontal and vertical mirror adjustment.

Annoying headlight glare can be reduced by moving the small control under the mirror to the night position (toward rear of vehicle). The mirror should be adjusted while set in the day position (toward windshield).

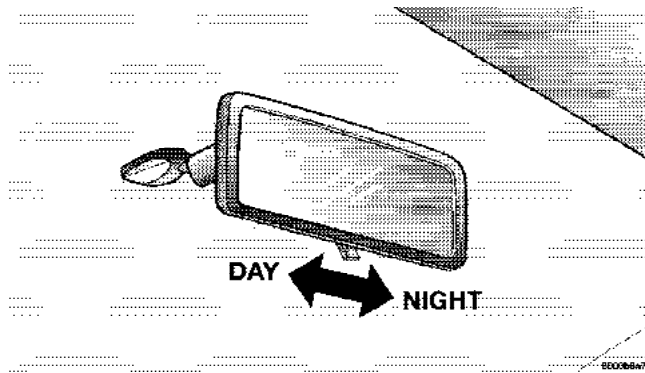

Adjusting Rear View Mirror

Outside Mirror—Driver’s Side

Adjust the outside mirror to center on the adjacent lane of traffic, with a slight overlap of the view obtained on the inside mirror.

Outside Mirror—Passenger’s Side

Adjust the convex outside mirror so you can just see the side of your vehicle in the part of the mirror closest to the vehicle.

WARNING!
Vehicles and other objects seen in the passenger side convex mirror will look smaller and farther away than they really are. Relying too much on your passenger side mirror could cause you to collide with another vehicle or other object. Use your inside mirror when judging the size or distance of a vehicle seen in this convex mirror.

Electric Remote-Control Mirrors — If Equipped

The power mirror switch is located to the left of the steering column on the instrument panel. To adjust the view in the outside mirrors, turn the rotary knob to the left (L), center (O) or Right (R) position. After selecting the mirror, move the knob in the same direction you want the mirror to move. Use the center (O) position to guard against accidentally moving a mirror position.

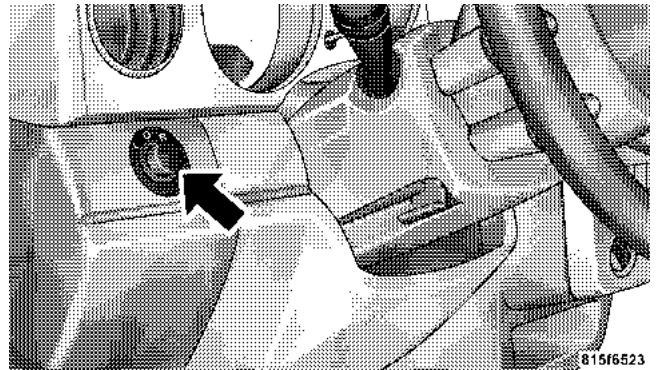

Power Mirror Switch

Illuminated Vanity Mirrors — If Equipped

NOTE: The driver vanity mirror will become inoperable when the vehicle alarm is enabled.

NOTE: The passenger vanity mirror will become inoperable if left on for more than 10 minutes.

An illuminated vanity mirror is on the sun visor. To use the mirror, rotate the sun visor down and swing the mirror cover upward. The lights turn on automatically. Closing the mirror cover turns off the lights.

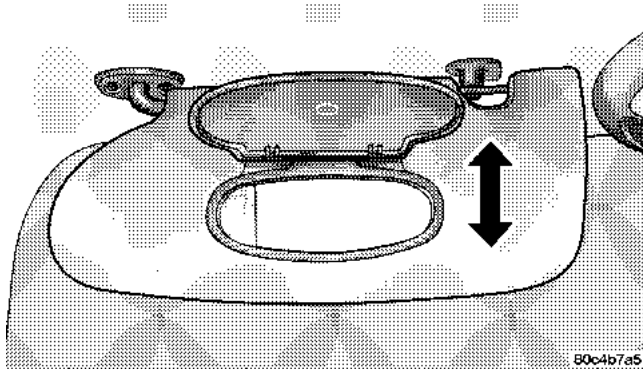

Illuminated Vanity Mirror

Sun Visor Sliding Feature

The sun visors may be pulled out to provide extended coverage of the side glass.

HANDS-FREE COMMUNICATION (UConnect™) — IF EQUIPPED

UConnect™ is a voice-activated, hands-free, in-vehicle communications system. UConnect™ allows you to dial a phone number with your cellular phone using simple voice commands (e.g., "Call" ... "Mike" ... "Work" or "Dial" ... "248-555-1212"). Your cellular phone's audio is transmitted through your vehicle's audio system; the system will automatically mute your radio when using the UConnect™ system.

NOTE: The UConnect™ system use requires a cellular phone equipped with the Bluetooth "Hands-Free Profile," version 0.96 or higher. See www.chrysler.com/uconnect for supported phones.

UConnect™ allows you to transfer calls between the system and your cellular phone as you enter or exit your vehicle, and enables you to mute the system’s microphone for private conversation.

The UConnect™ phonebook enables you to store up to 32 names and four numbers per name. Each language has a separate 32 name phonebook accessible only in that language. This system is driven through your Bluetooth™ Hands-Free profile cellular phone. UConnect™ features Bluetooth™ technology - the global standard that enables different electronic devices to connect to each other without wires or a docking station, so UConnect works no matter where you stow your cellular phone (be it your purse, pocket, or briefcase), as long as your phone is turned on and has been paired to the vehicle’s UConnect™ system. The UConnect™ system allows up to seven cellular phones to be linked to system. Only one linked (or paired) cellular phone can be used

with the system at a time. The system is available in English, Spanish, or French languages (as equipped).

The rearview mirror contains the microphone for the system and the control buttons that will enable you to access the system.

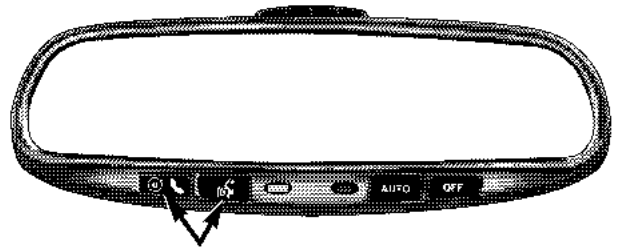

8105b20d

UConnect™ Switches

The UConnect™ system can be used with any Hands-Free Profile certified Bluetooth™ cellular phone. See www.chrysler.com/uconnect for supported phones. If your cellular phone supports a different profile (e.g., Headset Profile), you may not be able to use any UConnect™ features. Refer to your cellular service provider or the phone manufacturer for details.

The UConnect™ system is fully integrated with the vehicle's audio system. The volume of the UConnect™ system can either be adjusted from the radio volume control knob, or from the steering wheel radio control (right switch), if so equipped.

The radio display will be used for visual prompts from the UConnect™ system such as "CELL" or caller ID on certain radios.

Operations

Voice commands can be used to operate the UConnect™ system and to navigate through the UConnect™ menu structure. Voice commands are required after most UConnect™ system prompts. You will be prompted for a specific command and then guided through the available options.

- Prior to giving a voice command, one must wait for the voice on beep, which follows the "Ready" prompt or another prompt.
- For certain operations, compound commands can be used. For example, instead of saying "Setup" and then "Phone Pairing," the following compound command can be said: "Setup Phone Pairing."
- For each feature explanation in this section, only the combined form of the voice command is given. You can also break the commands into parts and say each part of the command, when you are asked for it. For

example, you can either use the combined form voice command "Phonebook New Entry," or you can break the combined form command into two voice commands: "Phonebook" and "New Entry." Please remember, the UConnect™ system works best when you talk in a normal conversational tone, as if speaking to someone sitting eight feet away from you.

Voice Command Tree

Refer to "Voice Tree" at the end of this section.

Help Command

If you need assistance at any prompt or if you want to know what your options are at any prompt, say "Help" following the voice on beep. The UConnect™ system will play all the options at any prompt if you ask for help.

To activate the UConnect™ system from idle, simply press the 'Phone' button and follow audible prompts for directions. All UConnect™ system sessions begin with a press of the 'Phone' button on the mirror.

Cancel Command

At any prompt, after the voice on beep, you can say "Cancel" and you will be returned to the main menu. However, in a few instances the system will take you back to the previous menu.

Pair (Link) UConnect™ System to a Cellular Phone

To begin using your UConnect™ system, you must pair your compatible Bluetooth™ enabled cellular phone.

NOTE: The UConnect™ system use requires a cellular phone equipped with the Bluetooth "Hands-Free Profile," version 0.96 or higher. See www.chrysler.com/uconnect for supported phones.

To complete the pairing process, you will need to reference your cellular phone owner's manual. One of the following vehicle specific websites may also provide detailed instructions for pairing with the brand of phone that you have:

NOTE:

- www.chrysler.com/uconnect
- www.dodge.com/uconnect
- www.jeep.com/uconnect

The following are general phone to UConnect™ System pairing instructions:

- Press the 'Phone' button to begin.
- After the "Ready" prompt and the following beep, say "Setup Phone Pairing."
- When prompted, after the voice on beep, say "Pair a Phone."
- You will be asked to say a four-digit pin number which you will later need to enter into your cellular. You can enter any four-digit pin number. You will not need to remember this pin number after the initial pairing process.
- The UConnect™ system will then prompt you to begin the cellular phone pairing process on your cellular phone. Before attempting to pair phone, please see your cellular phone's user manual (Bluetooth section) for instructions on how to complete this step.
- For identification purposes, you will be prompted to give the UConnect™ system a name for your cellular phone. Each cellular phone that is paired should be given a unique phone name.
- You will then be asked to give your cellular phone a priority level between 1 and 7, 1 being the highest priority. You can pair up to seven cellular phones to your UConnect™ system. However, at any given time, only one cellular phone can be in use, connected to your UConnect™ System. The priority allows the UConnect™ system to know which cellular phone to use if multiple cellular phones are in the vehicle at the same time. For example, if priority 3 and priority 5

phones are present in the vehicle, the UConnect™ system will use the priority 3 cellular phone when you make a call. You can select to use a lower priority cellular phone at any time (refer to "Advanced Phone Connectivity").

Dial by Saying a Number

- Press the 'Phone' button to begin.
- After the "Ready" prompt and the following beep, say "Dial."
- System will prompt you to say the number you want call.
- For example, you can say "234-567-8901." The phone number that you enter must be of valid length and combination. The UConnect™ limits the user from dialing invalid combination of numbers. For example,

234-567-890 is nine digits long, which is not a valid phone number - the closest valid phone number has ten digits.

- The UConnect™ system will confirm the phone number and then dial. The number will appear in the display of certain radios.

Call by Saying a Name

- Press the "Phone" button to begin.
- After the "Ready" prompt and the following beep, say "Call."
- System will prompt you to say the name of the person you want call.
- After the "Ready" prompt and the following beep, say the name of the person you want to call. For example,

you can say "John Doe," where John Doe is a previously stored name entry in the UConnect™ phonebook. Refer to "Add Names to Your UConnect™ Phonebook," to learn how to store a name in the phonebook.

- The UConnect™ system will confirm the name and then dial the corresponding phone number, which may appear in the display of certain radios.

Add Names to Your UConnect™ Phonebook

NOTE: Adding names to phonebook is recommended when vehicle is not in motion.

- Press the "Phone" button to begin.
- After the "Ready" prompt and the following beep, say "Phonebook New Entry."

- When prompted, say the name of the new entry. Use of long names helps the voice recognition and is recommended. For example, say "Robert Smith" or "Robert" instead of "Bob."
- When prompted, enter the number designation (e.g.: "Home," "Work," "Mobile," or "Pager"). This will allow you to store multiple numbers for each phonebook entry, if desired.
- When prompted, recite the phone number for the phonebook entry that you are adding.

After you are finished adding an entry into the phonebook, you will be given the opportunity to add more phone numbers to the current entry or to return to the main menu.

The UConnect™ system will allow you to enter up to 32 names in the phonebook with each name having up to

four associated phone numbers and designations. Each language has a separate 32 name phonebook accessible only in that language.

Edit Entries in the UConnect™ Phonebook

NOTE: Editing phonebook entries is recommended when vehicle is not in motion.

- Press the 'Phone' button to begin.
- After the "Ready" prompt and the following beep, say "Phonebook Edit."
- You will then be asked for the name of the phonebook entry that you wish to edit.
- Next, choose the number designation (home, work, mobile, or pager) that you wish to edit.
- When prompted, recite the new phone number for the phonebook entry that you are editing.

After you are finished editing an entry in the phonebook, you will be given the opportunities to edit another entry in the phonebook, call the number you just edited, or return to the main menu.

"Phonebook Edit" can be used to add another phone number to a name entry that already exists in the phonebook. For example, the entry John Doe may have a mobile and a home number, but you can add John Doe's work number later using the "Phonebook Edit" feature.

Delete Entries in the UConnect™ Phonebook

NOTE: Editing phonebook entries is recommended when vehicle is not in motion.

- Press the 'Phone' button to begin.
- After the "Ready" prompt and the following beep, say "Phonebook Delete."

- After you enter the Phonebook Delete menu, you will then be asked for the name of the entry that you wish to delete. You can either say the name of a phonebook entry that you wish to delete or you can say "List Names" to hear a list of the entries in the phonebook from which you choose. To select one of the entries from the list, press the "Voice Recognition" button while the UConnect™ system is playing the desired entry and say "Delete."
- After you enter the name, the UConnect™ system will ask you which designation you wish to delete: home, work, mobile or pager. Say the designation you wish to delete.
- Note that only the phonebook entry in the current language is deleted.

After confirmation, the phonebook entries will be deleted. Note that only the phonebook in the current language is deleted.

Delete All Entries in the UConnect™ Phonebook

- Press the 'Phone' button to begin.
- After the "Ready" prompt and the following beep, say "Phonebook Erase All."
- The UConnect™ system will ask you to verify that you wish to delete all the entries from the phonebook.
- After confirmation, the phonebook entries will be deleted.

List All Names in the UConnect™ Phonebook

- Press the 'Phone' button to begin.
- After the "Ready" prompt and the following beep, say "Phonebook List Names."
- The UConnect™ system will play the names of all the phonebook entries.

- To call one of the names in the list, press the "Voice Recognition" button during the playing of the desired name and say "Call." NOTE: the user can also exercise "Edit" or "Delete" operations at this point.
- The UConnect™ system will then prompt you as to number designation you wish to call.
- The selected number will be dialed.

Phone Call Features

The following features can be accessed through the UConnect™ system if the feature(s) are available on your cellular service plan. For example, if your cellular service plan provides three-way calling, this feature can be accessed through the UConnect™ system. Check with your cellular service provider for the features that you have.

Answer or Reject an Incoming Call - No Call Currently in Progress

When you receive a call on your cellular phone, the UConnect™ system will interrupt the vehicle audio system, if on, and will ask if you would like to answer the call. To reject the call, press and hold the 'Phone' button until you hear a single beep indicating that the incoming call was rejected.

Answer or Reject an Incoming Call - Call Currently in Progress

If a call is currently in progress and you have another incoming call, you will hear the same network tones for call waiting that you normally hear when using your cell phone. Press the 'Phone' button to place the current call on hold and answer the incoming call. NOTE: The UConnect™ system compatible phones in market today do not support rejecting an incoming call when another call is in progress. Therefore, the user can only either answer an incoming call or ignore it.

Making a Second Call while Current Call in Progress

To make a second call while you are currently in a call, press the 'Voice Recognition' button and say "Dial" or "Call" followed by the phone number or phonebook entry you wish to call. The first call will be on hold while the second call is in progress. To go back to the first call, refer to "Toggling Between Calls." To combine two calls, refer to "Conference Call."

Place/Retrieve a Call from Hold

To put a call on hold, press the 'Phone' button until you hear a single beep which will indicate that the call has been placed on hold. To bring the call back from hold, press and hold the 'Phone' button until you hear a single beep.

Toggling Between Calls

If two calls are in progress (one active and one on hold), press the 'Phone' button until you hear a single beep

indicating that the active and hold status of the two calls have switched. Only one call can be placed on hold at one time.

Conference Call

When two calls are in progress (one active and one on hold), press and hold the 'Phone' button until you hear a double beep indicating that the two calls have been joined into one conference call.

Three-Way Calling

To initiate three-way calling, press the 'Voice Recognition' button while a call is in progress and make a second phone call as described under "Making a Second Call while Current Call in Progress." After the second call has established, press and hold the 'Phone' button until you hear a double beep indicating that the two calls have been joined into one conference call.

Call Termination

To end a call in progress, momentarily press the 'Phone' button. Only the active call(s) will be terminated and if there is a call on hold, it will become the new active call.

Redial

- Press the 'Phone' button to begin.
- After the "Ready" prompt and the following beep, say "Redial."
- The UConnect™ system will call the last number that was dialed on your cellular phone. Note: this may not be the last number dialed from the UConnect™ system.

Call Continuation

Call continuation is progression of a phone call on UConnect™ system after the vehicle ignition key has been switched to off. Call continuation functionality available on the vehicle can be any one of three types:

- After ignition key is switched off, a call can continue on the UConnect™ system either until the call ends or until the vehicle battery condition dictates cessation of the call on the UConnect™ system and transfer of the call to the mobile phone.
- After ignition key is switched to off, a call can continue on the UConnect™ system for certain duration, after which the call is automatically transferred from the UConnect™ system to the mobile phone.
- An active call is automatically transferred to the mobile phone after ignition key is switched to off.

UConnect™ System Features**Language Selection**

To change the language that the UConnect™ system is using,

- Press the 'Phone' button to begin.

- After the "Ready" prompt and the following beep, say the name of the language you wish to switch to (English, Espanol, or Francais, if so equipped).
- Continue to follow the system prompts to complete language selection.

After selecting one of the languages, all prompts and voice commands will be in that language.

NOTE: After every UConnect™ language change operation, only the language specific 32 name phonebook is usable. The paired phone name is not language specific and usable across all languages.

Emergency Assistance

If you are in an emergency and the mobile phone is reachable:

- Pick up the phone and manually dial the emergency number for your area.

If the phone is not reachable and the UConnect™ system is operational, you may reach the emergency number as follows:

- Press the 'Phone' button to begin.
- After the "Ready" prompt and the following beep, say "Emergency" and the UConnect™ system will instruct the paired cellular phone to call the emergency number. This feature is only supported in the USA.

NOTE: The emergency number dialed is based on the Country where the vehicle is purchased (911 for USA and Canada and 060 for Mexico). The number dialed may not be applicable with the available cellular service and area.

The UConnect™ system does slightly lower your chances of successfully making a phone call as to that for the cell phone directly.

Your phone must be turned on and paired to the UConnect™ system to allow use of this vehicle feature in

emergency situations when the cell phone has network coverage and stays paired to the UConnect™ system.

Towing Assistance

If you need towing assistance,

- Press the 'Phone' button to begin.
- After the "Ready" prompt and the following beep, say "Towing Assistance."

NOTE: The Towing Assistance number dialed is based on the Country where the vehicle is purchased (1-800-528-2069 for USA, 1-877-213-4525 for Canada, 55-14-3454 for Mexico city and 1-800-712-3040 for outside Mexico city in Mexico).

Please refer to the 24-Hour "Towing Assistance" coverage details in the Warranty information booklet and on the 24-Hour Towing Assistance Card.

Paging

To learn how to page, refer to "Working with Automated Systems." Paging works properly except for pagers of certain companies which time-out a little too soon to work properly with the UConnect™ system.

Voice Mail Calling

To learn how to access your voice mail, refer to "Working with Automated Systems."

Working with Automated Systems

This method is designed to be used in instances where one generally has to press numbers on the cellular phone keypad while navigating through an automated telephone system.

You can use your UConnect™ system to access a voice-mail system or an automated service, such as, paging service or automated customer service. Some services require immediate response selection, in some instances, that may be too quick for use of UConnect™ system.

When calling a number with your UConnect™ system that normally requires you to enter in a touch-tone sequence on your cellular phone keypad, you can push the 'Voice Recognition' button and say the sequence you wish to enter followed by the word "Send." For example, if required to enter your pin number followed with a pound 3 7 4 6 #, you can press the 'Voice Recognition' button and say "3 7 4 6 # Send." Saying a number, or sequence of numbers, followed by "Send" is also to be used to navigate through an automated customer service center menu structure and to leave a number on a pager.

Barge In - Overriding Prompts

The 'Voice Recognition' button can be used when you wish to skip part of a prompt and issue your voice recognition command immediately. For example, if a prompt is playing "Would you like to pair a phone, clear a...," you could press the 'Voice Recognition' button and say "Pair a Phone" to select that option without having to listen to the rest of the voice prompt.

Turning Confirmation Prompts On/Off

Turning confirmation prompts off will stop the system from confirming your choices (e.g. the UConnect™ system will not repeat a phone number before you dial it).

- Press the 'Phone' button to begin.
- After the "Ready" prompt and the following beep, say "Setup Confirmations." The UConnect™ system will play the current confirmation prompt status and you will be given the choice to change it.

Phone and Network Status Indicators

If available on the radio and/or on a premium display such as the instrument panel cluster, and supported by your cell phone, the UConnect™ system will provide notification to inform you of your phone and network status when you are attempting to make a phone call using UConnect™. The status is given for roaming network signal strength, phone battery strength, etc.

Dialing Using the Cellular Phone Keypad

You can dial a phone number with your cellular phone keypad and still use the UConnect™ system (while dialing via the cell phone keypad, the user must exercise caution and take precautionary safety measures). By dialing a number with your paired Bluetooth™ cellular phone, the audio will be played through your vehicle's audio system. The UConnect™ system will work the same as if you dial the number using voice recognition.

NOTE: Certain brands of mobile phones do not send the dial ring to the UConnect™ system to play it on the vehicle audio system, so you will not hear it. Under this situation, after successfully dialing a number, the user may feel that the call did not go through even though the call is in progress. Once your call is answered, you will hear the audio.

Mute/Un-mute (Mute off)

When you mute the UConnect™ system, you will still be able to hear the conversation coming from the other party, but the other party will not be able to hear you. In order to mute the UConnect™ system:

- Press the 'Voice Recognition' button.
- After the "Ready" prompt and the following beep, say "Mute."

In order to un-mute the UConnect™ system:

- Press the 'Voice Recognition' button.
- After the "Ready" prompt and the following beep, say "Mute-off."

Information Service

When using AT&T Wireless Service, dialing to phone number "#121," you can access voice activated automated system to receive news, weather, stocks, traffic, etc. related information.

Advanced Phone Connectivity**Transfer Call to and from Cellular Phone**

The UConnect™ system allows on going calls to be transferred to your cellular phone to the UConnect™ system without terminating the call. To transfer an ongoing call from your UConnect™ paired cellular phone to the UConnect™ system or vice-versa, press the 'Voice Recognition' button and say "Transfer Call."

Connect or Disconnect Link Between the UConnect™ System and Cellular Phone

Your cellular phone can be paired with many different electronic devices, but can only be actively "connected" with one electronic device at a time.

If you would like to connect or disconnect the Bluetooth™ connection between a UConnect™ paired cellular phone and the UConnect™ system, follow the instruction described in your cellular phone user's manual.

List Paired Cellular Phone Names

- Press the 'Phone' button to begin.
- After the "Ready" prompt and the following beep, say "Setup Phone pairing".
- When prompted, say "List Phones."
- The UConnect™ system will play the phone names of all paired cellular phones in order from the highest to the lowest priority. To "select" or "delete" a paired phone being announced, press the 'Voice recognition' button and say "Select" or "Delete." Also, see the next two sections for an alternate way to "select" or "delete" a paired phone.

Select another Cellular Phone

This feature allows you to select and start using another phone with the UConnect™ system. The phone must have been previously paired to the UConnect™ system that you want to use it with.

- Press the 'Phone' button to begin.
- After the "Ready" prompt and the following beep, say "Setup Select Phone."
- The phone names along with priority numbers will be announced.
- When prompted say the priority number of the cellular phone you wish to select. You can also press the 'Voice Recognition' button anytime while the list is being played, then say the priority number of the phone that you wish to select.

- The selected phone will be used for the next phone call. If the selected phone is not available, the UConnect™ system will return to using the highest priority phone present in or near (approximately within 30 feet) the vehicle.

Delete UConnect™ Paired Cellular Phones

- Press the 'Phone' button to begin.
- After the "Ready" prompt and the following beep, say "Setup Phone Pairing."
- At the next prompt, say "Delete."
- The phone names along with priority numbers will be announced.
- When prompted say the priority number of the cellular phone you wish to delete. You can also press the

'Voice Recognition' button anytime while the list is being played and say the priority number of the phone you wish to delete.

Things You Should Know About Your UConnect™ System

Voice Recognition (VR)

- Always wait for the beep before speaking.
- Speak normally, without pausing, just as you would speak to a person sitting approximately eight (8) feet away from you.
- Make sure that no one other than you is speaking during a voice recognition period.
- Performance is maximized under:
 - low-to-medium blower setting,
 - low-to-medium vehicle speed,
 - low road noise,
 - smooth road surface,
 - fully closed windows,
 - dry weather condition.
- Even though the system is designed for users speaking in North American English, French, and Spanish accents, the system may not always work for some.
- When navigating through an automated system, such as, voice mail, or when sending a page, at the end of speaking the digit string, make sure to say "send."
- Storing names in phonebook when vehicle is not in motion is recommended.
- It is not recommended to store similar sounding names in the UConnect™ phonebook.

- UConnect™ phonebook name tag recognition rate is optimized for the voice of the person who stored the name in the phonebook.
- You can say "O" (letter "O") for "0" (zero). "800" must be spoken "eight-zero-zero."
- Even though international dialing for most number combinations is supported, some shortcut dialing number combinations may not be supported.

Far End Audio Performance

- Audio quality is maximized under:
 - low-to-medium blower setting,
 - low-to-medium vehicle speed,
 - low road noise,
 - smooth road surface,
 - fully closed windows, and

- dry weather condition.
- Operation from driver seat.
- Performance, such as, audio clarity, echo, and loudness to a large degree, rely on the phone and network, and not the UConnect™ system.
- Echo at far end can sometime be reduced by lowering the in-vehicle audio volume.

Bluetooth Communication Link

Cellular phones have been found to occasionally lose connection to the UConnect™ system. When this happens, the connection can generally be re-established by switching the phone off/on. Your cell phone is recommended to remain in Bluetooth "on" mode.

Power-Up

After switching the ignition key from OFF to either ON or ACC position, or after a reset, you must wait at least five (5) seconds prior to using the system.

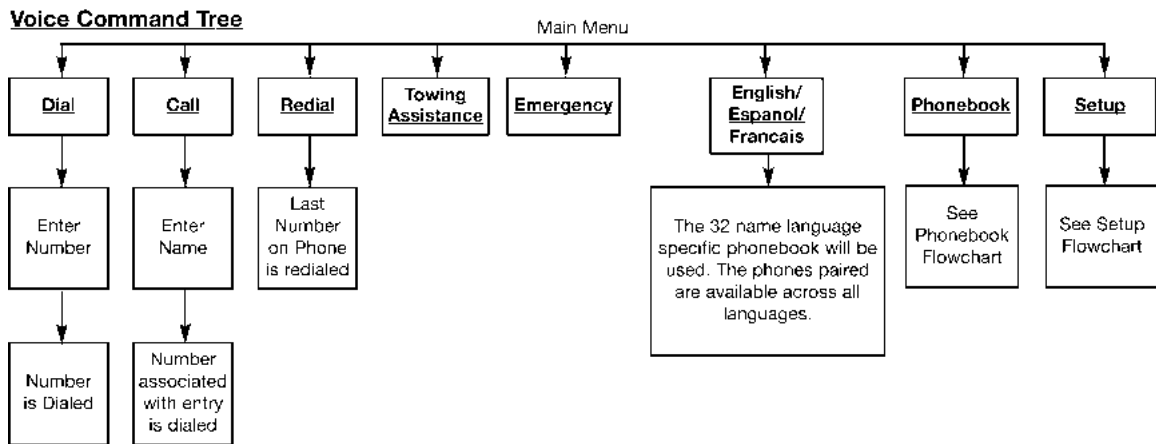

Note: Available Voice commands are shown in bold face and are underlined.

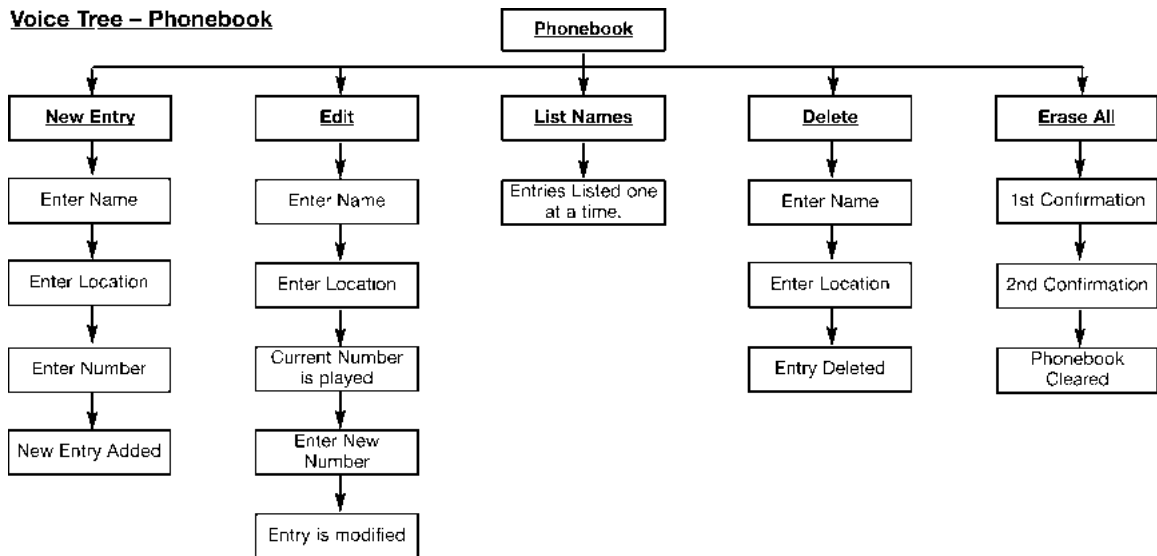

Note: Available Voice commands are shown in bold face and are underlined.

8131b294

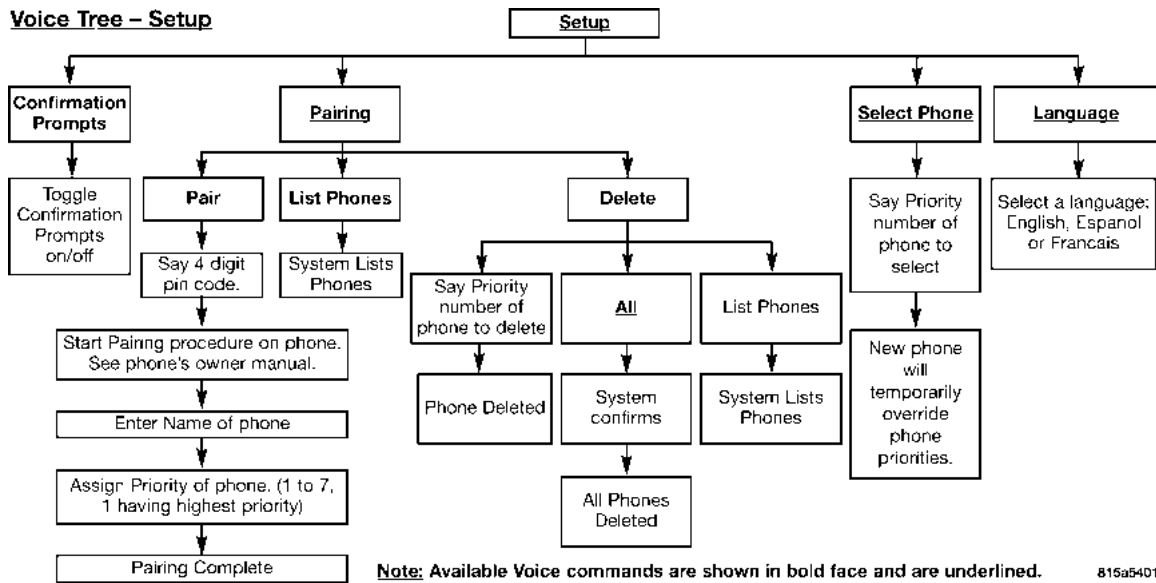

	North American English
Primary	Alternate(s)
Zero	Oh
Add location	Add new
All	All of them
Confirmation prompts	Confirmations prompts
Delete a name	Delete
Language	Select language
List names	List all
List paired phones	List phones
Pager	Beeper
Phone pairing	Pairing
Phonebook	Phone book
Return to main menu	Return. Main menu
Select phone	select
Set up	Phone settings phone set up

SEATS

Front Seat Adjustment

The adjusting bar is at the front of the seats, near the floor. Pull the bar up to move the seat to the desired position.

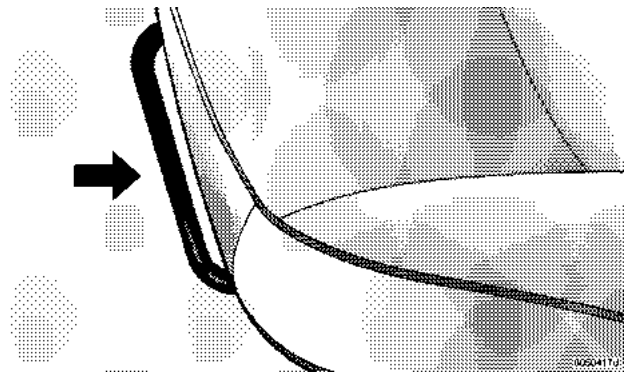

Manual Adjusting Bar

Using body pressure, move forward and rearward on the seat to be sure the seat adjusters have latched.

WARNING!

- Adjusting a seat while the vehicle is moving is dangerous. The sudden movement of the seat could cause you to lose control. The seat belt might not be properly adjusted and you could be injured. Adjust the seat only while the vehicle is parked.
- Do not ride with the seatback reclined so that the shoulder belt is no longer resting against your chest. In a collision you could slide under the seat belt and be seriously or even fatally injured. Use the recliner only when the vehicle is parked.

Power Seat Adjuster — If Equipped

WARNING!

Do not ride with the seatback reclined so that the seat belt is no longer resting against your chest. In a collision you could slide under the seat belt and be seriously or even fatally injured. Use the recliner only when the vehicle is parked.

6-Way Power Seat with Manual Recliner

The seat switch is on the outboard side of the seat near the floor. Use this switch to move the seat up or down, forward or rearward, or to tilt the seat.

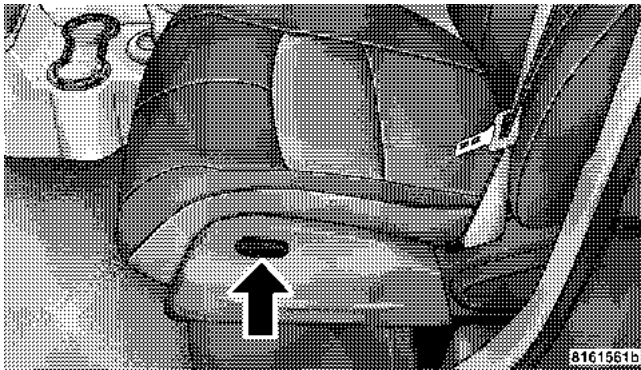

Power Seat Switch

This seat also has a manual recline lever located just to the rear of the power seat switch. To recline, lean forward slightly before lifting the lever, then lean back to the desired position and release the lever. Lean forward and lift the lever to return the seatback to its normal position.

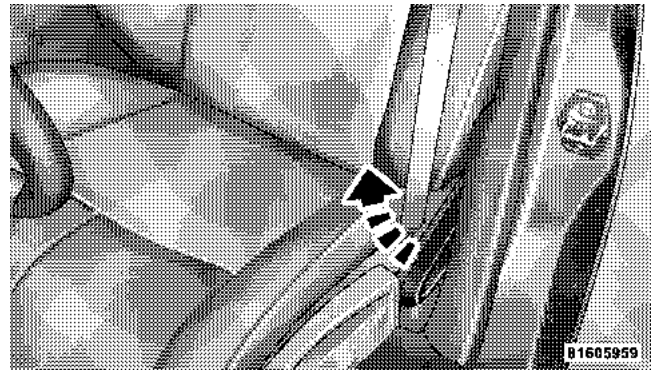

Recliner Control Lever

Manual Lumbar—If Equipped

The Lumbar adjustment is located on the inboard side of the driver's seat. To increase support, rotate the handle down.

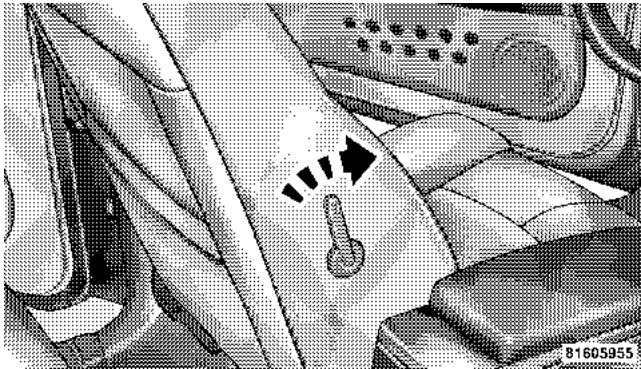

Lumbar Adjust Handle

Folding Front Passenger Seat — If Equipped

The passenger front seat may be folded fully forward to provide additional cargo space.

To fold the seat forward pull up on the recliner lever located on the outboard side of the seat.

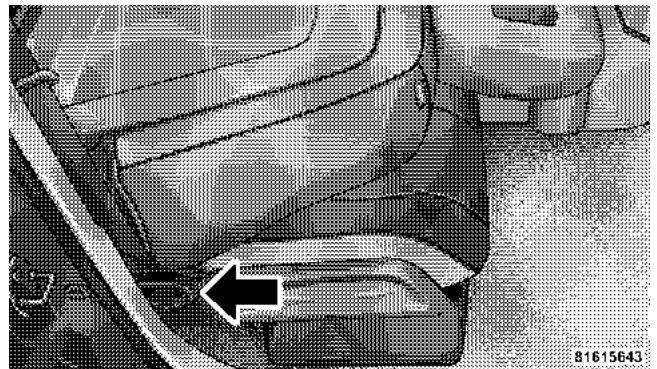

Folding Seat Control Lever

Driver's Seat Back Tilt—If Equipped

How to operate the driver's seat:

1. Push the lever down until seat back releases.
2. Push the seat back forward.
3. To return seat to a sitting position, push seat back rearward.

NOTE: The driver's front seat has a full recliner memory, which will allow the seat back to return to its original position.

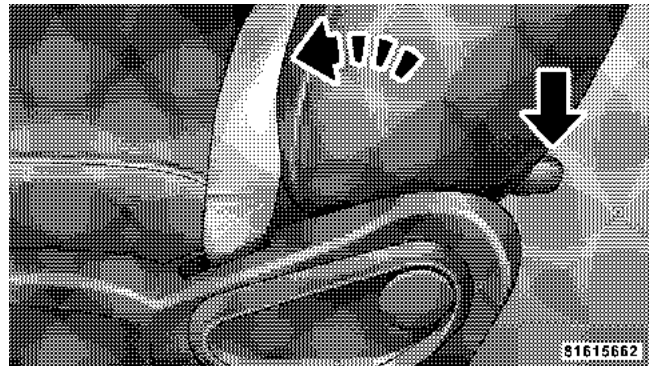

Driver's Seat Back Tilt Lever

**Passenger Seat Back Tilt (Easy Entry System)
(Convertible)**

How to operate the passenger front seat:

1. Push the lever down until seat back releases.

2. Push seat back forward until it slides toward the dashboard.



Passenger Seat Back Tilt Lever

3. To return seat to a sitting position, rotate seat back upright until it locks.
4. Push seat rearward until the track locks.

NOTE: The passenger front seat has a full recliner memory, which will allow the seat back to returned to its original position.

NOTE: The passenger front seat has a track memory, which returns the seat to just past the half way point of the track regardless of original position.

Adjustable Head Restraints

Head restraints can reduce the risk of whiplash injury in the event of impact from the rear. Pull up or push down on the head restraints so that the upper edge is as high as practical. To raise the head restraint, pull up on the head restraint. To lower the head restraint, depress the button and push down on the head restraint.

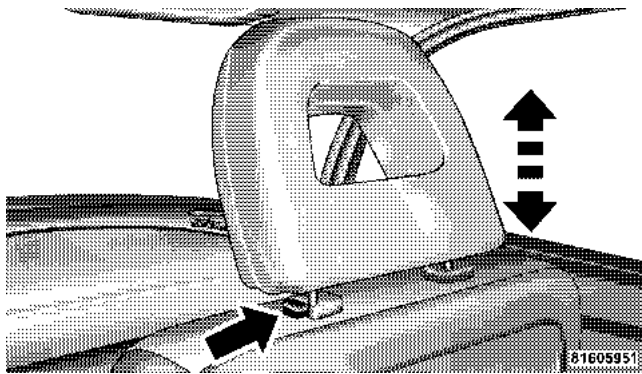

Adjustable Head Restraints

Heated Seats — If Equipped

This feature heats the front driver's and passenger's seats. The control for the heater is located on the instrument panel, below the radio. After turning on the ignition, you may choose OFF, HIGH, or LOW heat settings. An indicator on the switch shows which setting has been chosen.

3

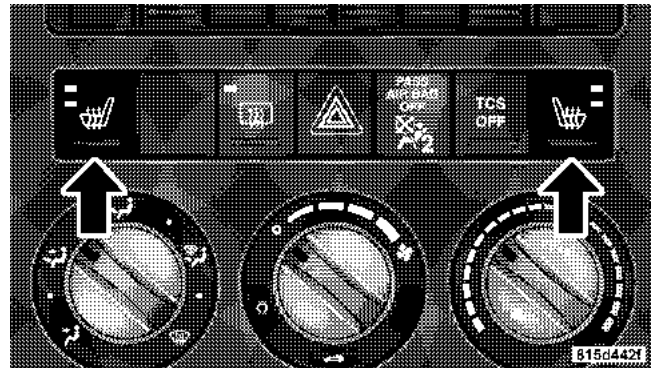

Heated Seat Switch

Pressing the switch once will select high-level heating.

Pressing the switch a second time will select low-level heating. Pressing the switch a third time will shut the heating elements off.

When high-temperature heating is selected, the heaters provide a boosted heat level during the first four minutes of operation after heating is activated. The heat output then drops to the normal high-temperature level. If high-level heating is selected, the system will automatically switch to the low level after about 30 minutes of continuous operation. At that time, the number of illuminated LEDs changes from two to one, indicating the change. Operation on the low setting also turns off automatically after about 30 minutes of continuous operation.

NOTE: Once a heat setting is selected, heat will be felt within 2 to 3 minutes.

Folding Rear Seat (Sedan)

To provide additional storage area, each rear seatback can be folded forward. Push and hold the buttons shown in the picture to fold down either or both seatbacks.

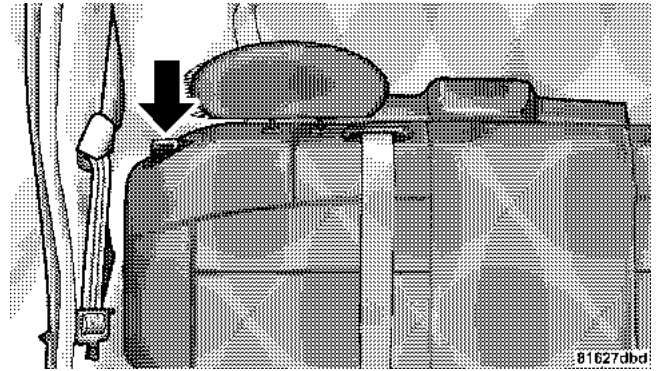

Folding Rear Seat Button

WARNING!

- It is extremely dangerous to ride in a cargo area, inside or outside of a vehicle. In a collision, people riding in these areas are more likely to be seriously injured or killed.
- Do not allow people to ride in any area of your vehicle that is not equipped with seats and seat belts
- Be sure that everyone in your vehicle is in a seat and using a seat belt properly.

NOTE:

- If the rear center lap/shoulder belt appears to be locked into place, check to verify that the seatback is fully latched.

- If the seatback is properly latched and the rear center lap/shoulder belt still does not operate properly check and see if the Automatic Locking retractor (ALR) system is activated.

WARNING!

The rear center lap/shoulder belt is equipped with a lock-out feature to ensure that the seatback is in the fully upright and locked position when occupied. If the rear seatback is not fully upright and locked and the rear center lap/shoulder belt can be pulled out of the retractor, the vehicle should immediately be taken to your dealer for service. Failure to follow this warning could result in serious or fatal injury.

Folding Rear Seat (Convertible)

To provide additional storage area, each rear seatback can be folded forward. The seat back release knobs are located in the trunk area. Pull the left side seatback release knob to fold down the left side seatback. Pull the right side seatback release knob to fold down the right side seatback.

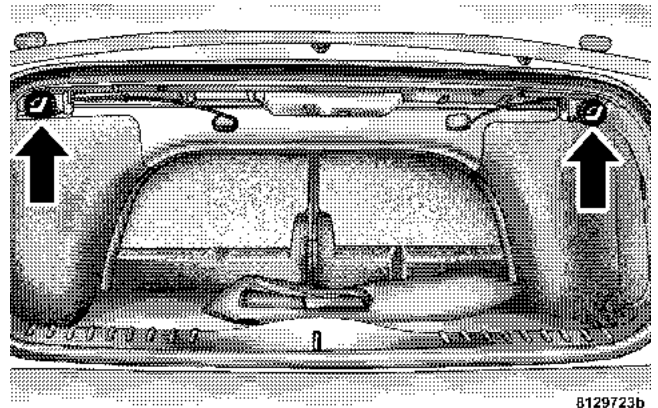

8129723b

Folding Rear Seat Release Knobs

WARNING!

- It is extremely dangerous to ride in a cargo area, inside or outside of a vehicle. In a collision, people riding in these areas are more likely to be seriously injured or killed.
- Do not allow people to ride in any area of your vehicle that is not equipped with seats and seat belts.
- Be sure that everyone in your vehicle is in a seat and using a seat belt properly.

NOTE: Prior to lifting either seatback to the upright position, be sure that the seat belt is brought forward to avoid trapping it behind the seatback.

Tumbling Rear Seat (Sedan)

To provide additional storage in the cargo area, each rear seat can be tumbled forward.

CAUTION!

It is important that the front seats be pulled forward to the midpoint of the seat track to avoid contact between the rear seat and the front seatback. If the front seat is not pulled forward the two seats will make contact during the tumbling motion and cause damage to the rear seat material. After the rear seat is tumbled forward and secured the front seat can then be repositioned to the preferred position.

170 UNDERSTANDING THE FEATURES OF YOUR VEHICLE

- Push and hold the button on the seatback and fold down the rear seatback.

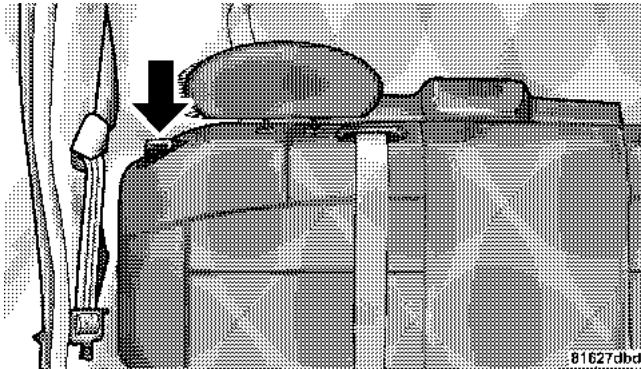

Folding Rear Seat Button

- Pull the release handle located on the outboard side of the seat. Lift up the seat and tumble the seat forward.

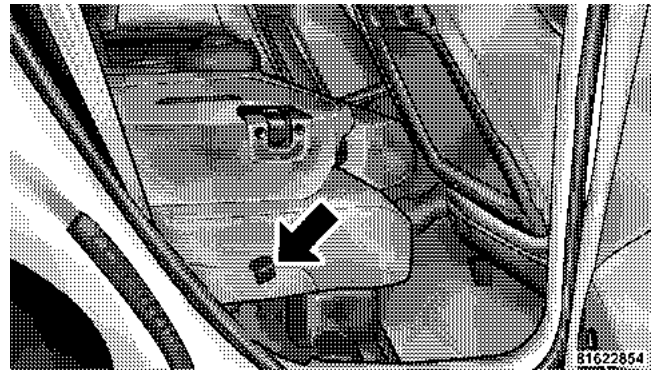

Tumbling Seat Release Strap

- Attach the elastic strap, located at the base of the seat cushion, onto the hook bar on the center trim panel to hold the seat in place.

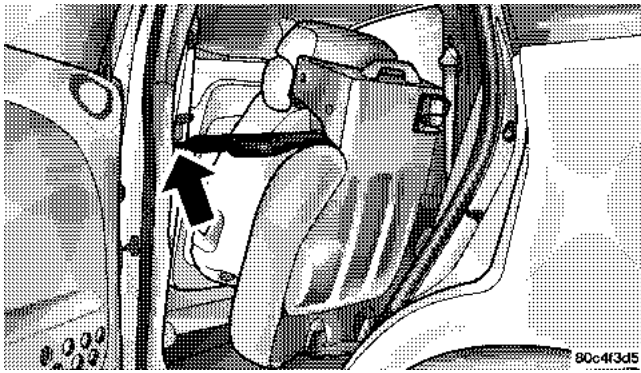

Tumbling Seat Strap

To return the rear seat to its upright latched position, rotate the seat cushion rearward to latch the seat. Then lift the seatback to its upright latched position.

NOTE: The elastic strap should be reinstalled in the clip on the base of the seat cushion before returning the seat to its normal position.

Tumbling Rear Seat (Convertible)

To provide additional storage area, each rear seat can be tumbled forward.

CAUTION!

It is important that the front seats be pulled forward to the midpoint of the seat track to avoid contact between the rear seat and the front seatback. If the front seat is not pulled forward the two seats will make contact during the tumbling motion and cause damage to the rear seat material. After the rear seat is tumbled forward and secured the front seat can then be repositioned to the preferred position.

3

To tumble the seat forward use the following procedure:

1. The seat back release knobs are located in the trunk area. Pull the left side seatback release knob to fold down

172 UNDERSTANDING THE FEATURES OF YOUR VEHICLE

the left side seatback. Pull the right side seatback release knob to fold down the right side seatback.

2. From inside the vehicle, fold the rear seat back down flat.

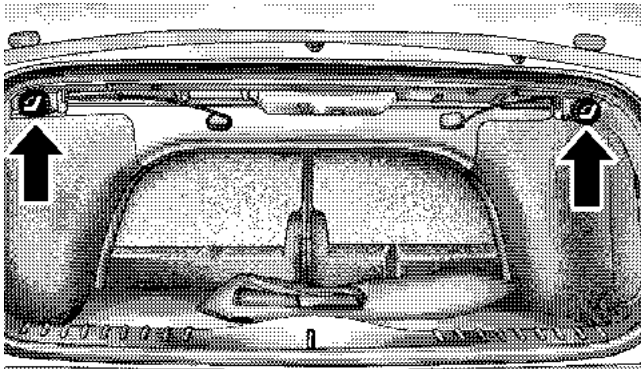

8129723b

Folding Rear Seat Release Knobs

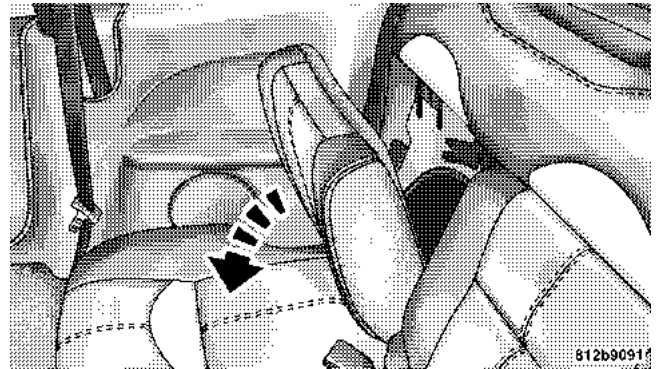

812b9091f

Folding Rear Seat Back

3. Pull the release handle located at the bottom of the folded seat back and tumble the seat forward.

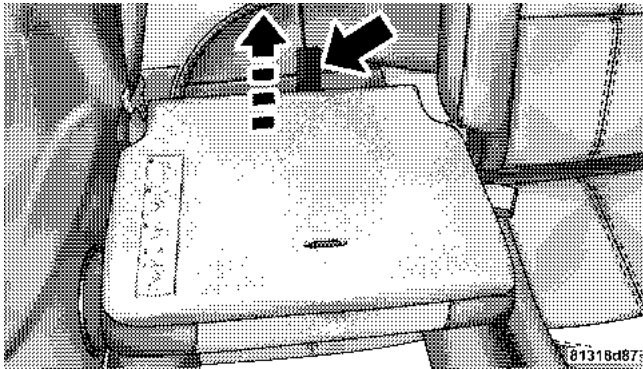

Tumbling Rear Seat

4. Attach the cinching tether strap, located at the side of the seat cushion, onto the hook bar on the center trim panel and tighten by pulling the cinching strap until the seat is secure.

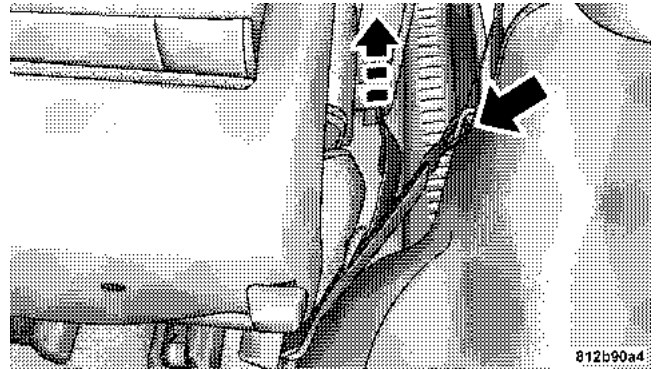

Cinching Tether Strap

To return the tumbling rear seat to the latched (normal) position use the following procedure:

1. Loosen the strap by pushing rearward on the cinching tether strap buckle.

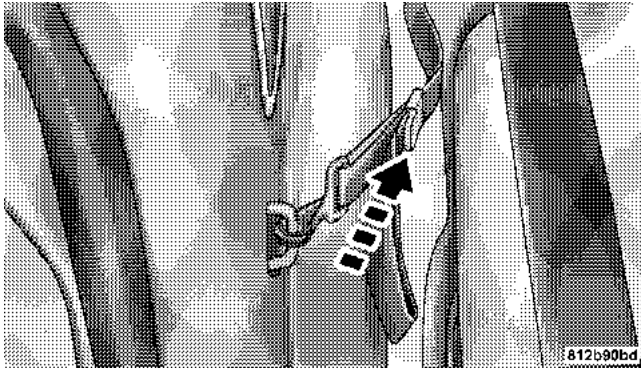

Releasing Cinching Tether Strap

2. Disconnect the cinching tether strap.

NOTE: The strap should be reinstalled in the side pocket on the seat cushion before returning the seat to the latched (normal) position.

NOTE: Prior to rotating the seat cushions rearward, be sure that the rear seat belt buckles are secured with the straps, so that the buckles are accessible.

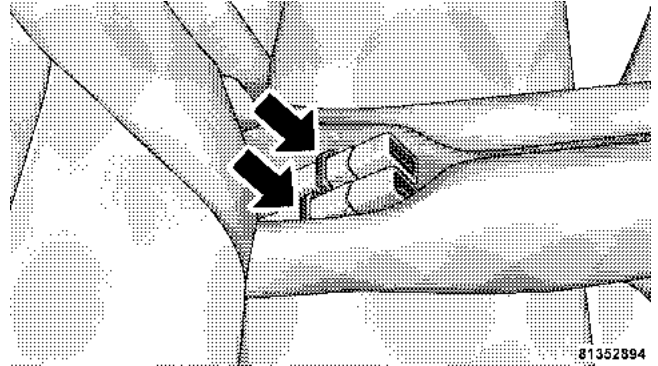

Rear Seat Belt Buckle Straps

NOTE: Prior to lifting either seatback to the upright position, be sure that the seat belt is brought forward to avoid trapping it behind the seatback.

3. Rotate the seat cushion rearward to latch the seat. Then lift the seatback to its upright latched position.

WARNING!

In an accident, you or others in your vehicle could be injured if seats are not properly latched to their attachments. Always be sure the seats are fully latched.

Rear Seat Removal (Sedan)

The rear seats can be removed to provide more cargo space.

- Push and hold the button on the seatback and fold down the rear seatback.

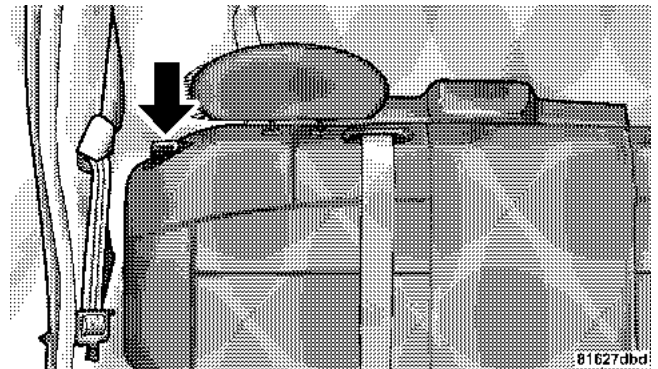

Folding Rear Seat Button

- Pull the release lever located on the outboard side of the seat. Lift up the seat and tumble the seat forward.

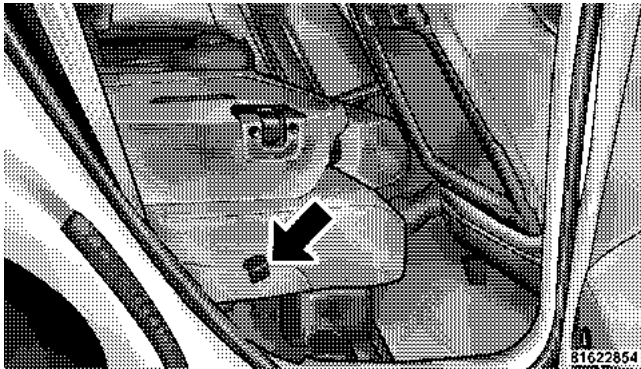

Tumbling Seat Release Strap

- Lift up the release levers to disengage the seat from the floor attachments.

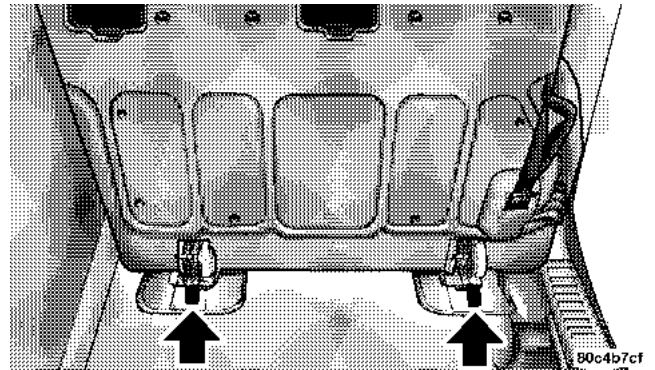

Release Lever Location

- Using the handle on the seat, the seat assembly can now be lifted and removed from the vehicle.

NOTE: Small rollers on the bottom of the folded seat and a handle at the top allow the seat to be easily moved when removed from the vehicle.

To reinstall the rear seat, insert the seat into the floor attachments. Lower the release levers of the seat to latch the front floor attachments and rotate the seat rearward to latch the seat. Lift the seat back to its upright latched position.

WARNING!

In an accident, you or others in your vehicle could be injured if seats are not properly latched to their floor attachments. Always be sure the seats are fully latched.

TO OPEN AND CLOSE THE HOOD

To open the hood, two latches must be released. First pull the hood release lever located under the left side of the instrument panel.

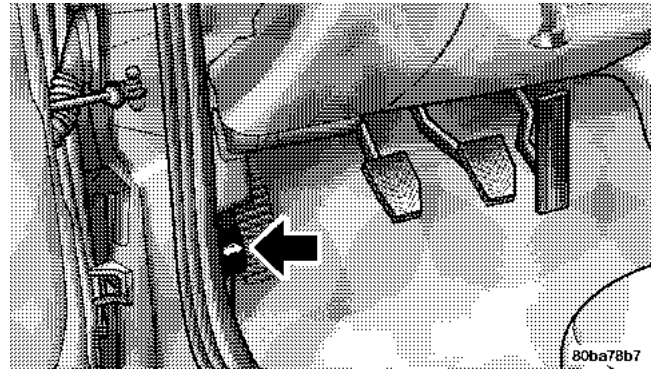

Hood Release Lever

Then move the safety catch located under the front edge of the hood, near the center and slightly to the right, and raise the hood.

Use the hood prop rod clipped to the driver's side of the engine compartment to secure the hood in the open position. Place the hood prop at the location stamped into the inner hood surface.

To prevent possible damage, do not slam the hood to close it. Lower the hood until it is open approximately 20 cm (8 inches) and then drop it. This should secure both latches. Never drive your vehicle unless the hood is fully closed, with both latches engaged.

WARNING!

If the hood is not fully latched it could fly up when the vehicle is moving and block your forward vision. You could have a collision. Be sure all hood latches are fully latched before driving.

LIGHTS

Map/Reading Lights (Sedan)

These lights are mounted between the sun visors above the rear view mirror. Each light is turned ON by pressing the button. Press the button a second time to turn the light OFF. The lights also come on when a door is opened or the dimmer control is turned fully upward, past the second detent.

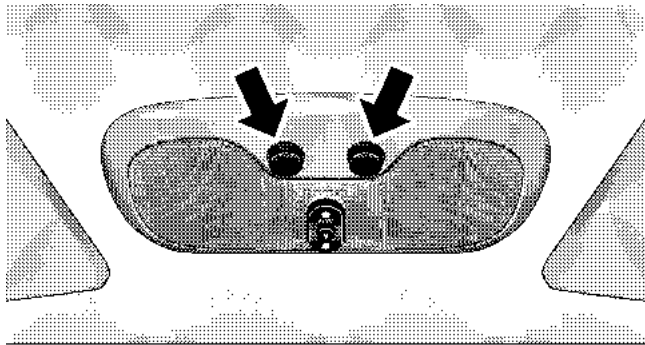

815d4389

NOTE: The lights will remain on until the switch is pressed a second time, so be sure they have been turned off before leaving the vehicle. They will not turn off automatically.

Map/Reading Lights (Convertible)

When the ignition switch is in the ON position, these lights, located under the rearview mirror can be turned on by switches located at the base of the rearview mirror.

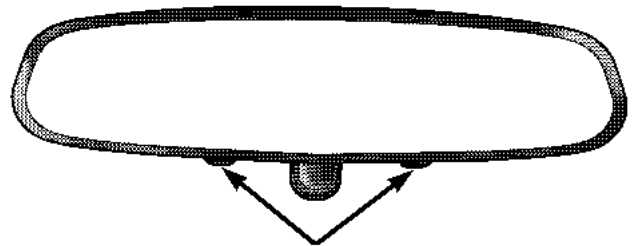

SWITCHES

80ce5aaa

NOTE: The lights will remain on until the switch is pressed a second time, so be sure they have been turned off before leaving the vehicle. They will not turn off automatically.

Interior Lights

The interior lights come on when a door or deck lid (convertible) is opened.

With the ignition key in the OFF position, the interior lights will automatically turn off in about 10 minutes if a door is left open or the dimmer control is left in the Dome light position. The interior lights will remain on for only 90 seconds for all occurrences after that, until the engine is turned on and off.

Dimmer Control

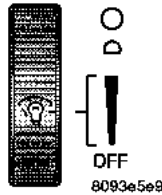

With the parking lights or headlights on, rotating the dimmer control for the interior lights on the Multi-Function Control Lever upward will increase the brightness of the instrument panel lights.

Dome Light Position

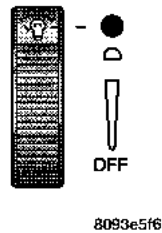

Rotate the dimmer control completely upward to the second detent to turn on the interior lights. The interior lights will remain on when the dimmer control is in this position. With the ignition key in the OFF position, the interior lights will automatically turn off in about 10 minutes if the dimmer

control is left in the Dome light position or a door is left open. The interior lights will remain on for only 90 seconds for all occurrence after that, until the engine is turned on and off.

Interior light Defeat (OFF)

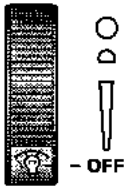

8093e60e

Rotate the dimmer control to the extreme bottom "OFF" position. The interior lights will remain off when the doors are open.

Parade Mode (Daytime Brightness Feature)

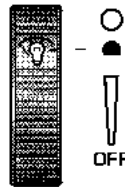

8093e650

Rotate the dimmer control to the first detent (white semi-circle). This feature brightens the odometer and radio display when the parking lights or headlights are on during daylight conditions.

Multi-Function Control Lever

The Multi-Function Control Lever controls the operation of the headlights, parking lights, turn signals, headlight beam selection, instrument panel light dimming, interior lights, the passing lights, and fog lights. The lever is located on the left side of the steering column.

Headlights, Parking Lights, Instrument Panel Lights

Turn the end of the Multi-Function Control Lever to the first detent for parking light operation. Turn to the second detent for headlight operation.

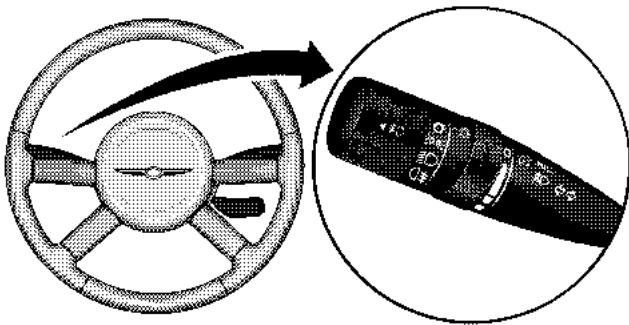

817e29ca

Multi-Function Lever Control Lever

To change the brightness of the instrument panel lights, rotate the center portion of the Multi-Function Control Lever up or down.

Daytime Running Lights (DRL)(Canada Only)

The high beam lamps will come on as Daytime Running Lights (DRL) at DRL intensity, whenever the ignition is on, the headlamp switch is off, engine is running, the parking brake is off and the gear shift is in any position except park.

Lights-on Reminder

If the headlights or parking lights are on after the ignition is turned OFF, a chime will sound to alert the driver when the driver's door is opened.

Fog Lights — If Equipped

 The front fog light switch is on the Multi-Function Control Lever. To activate the front fog lights, turn on the parking lights or the low beam headlights and pull out the end of the control lever.

NOTE: The fog lights will only operate with the headlights on low beam. Selecting high beam headlights will turn off the fog lights.

Turn Signals

Move the Multi-Function Control Lever up or down and the arrows on each side of the instrument cluster flash to show proper operation of the front and rear turn signal lights. You can signal a lane change by moving the lever partially up or down without moving beyond the detent.

If either light remains on and does not flash, or there is a very fast flash rate, check for a defective outside light

bulb. If an indicator fails to light when the lever is moved, it would suggest that the fuse or indicator bulb is defective.

Highbeam/Lowbeam Select Switch

Push the Multi-Function Control Lever away from you to switch the headlights to HIGH beam. Pull the Lever towards you to switch the headlights back to Low beam.

Passing Light

You can signal another vehicle with your headlights by lightly pulling the Multi-Function Control Lever toward you. This will cause the headlights to turn on at high beam and remain on until the lever is released.

NOTE: If the Multi-Function Control Lever is held in the flash to pass position for more than 15 seconds, the high beams will shut off. If this occurs, wait 30 seconds for the next flash to pass operation.

WINDSHIELD WIPERS AND WASHERS



The wipers and washers are operated by a switch on the control lever. The lever is located on the right side of the steering column. Rotate the control to select the desired wiper speed.

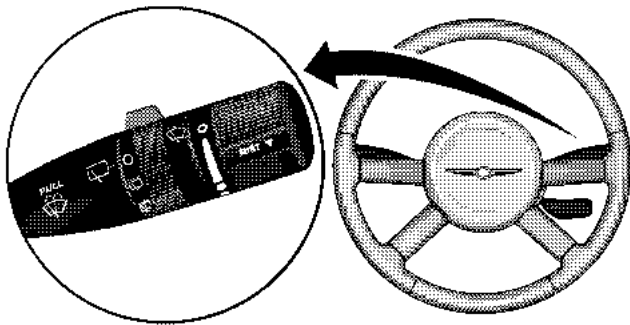

Wiper/Washer Switch

817e1f91

Windshield Washers

To use the washer, pull the control lever toward you and hold while spray is desired. If the lever is pulled while in the delay range, the wiper will operate in low speed for two wipe cycles after the lever is released, and then resume the intermittent interval previously selected.

If the lever is pulled while in the OFF position, the wipers will operate for two wipe cycles, then turn OFF.

Mist Feature

Push down on the wiper control lever to activate a single wipe to clear the windshield of road mist or spray from a passing vehicle. As long as the lever is held down, the wipers will continue to operate.

CAUTION!

In cold weather, always turn off the wiper switch and allow the wipers to return to the park position before turning off the engine. If the wiper switch is left on and the wipers freeze to the windshield, damage to the wiper motor may occur when the vehicle is restarted.

Windshield Wiper Operation

Rotate the control to the second detent for Low speed wiper operation, or to the third detent for High speed operation

Intermittent Wiper System

The intermittent feature of this system was designed for use when weather conditions make a single wiping cycle,

with a variable pause between cycles, desirable. For maximum delay between cycles, rotate the control knob into the upper end of the delay range.

The delay interval decreases as you rotate the knob until it enters the LO continual speed position.

WARNING!

Sudden loss of visibility through the windshield could lead to an accident. You might not see other vehicles or other obstacles. To avoid sudden icing of the windshield during freezing weather, warm the windshield with defroster before and during windshield washer use.

NOTE: If the front wiper is operating when the ignition is turned off, the wiper will automatically return to the "Park" position. When the vehicle is restarted, the wipers will resume operation.

Rear Window Wiper/Washer (Sedan Models Only)

A switch on the right side of the steering column controls operation of the rear wiper/washer function. Rotating the center of the switch forward to the ON position will activate the wiper. Rotating the center of the switch all the way forward will turn on the wash function. The wash pump will continue to operate as long as the button is pressed. Upon release, the wipers will cycle two times before returning to the set position.

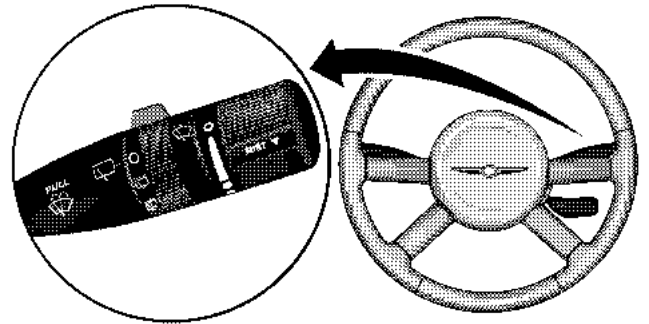

817e1f91

Wiper/Washer Switch

If the rear wiper is operating when the ignition is turned OFF, the wiper will automatically return to the "Park" position if power accessory delay is active. Power accessory delay can be cancelled by opening the door, if this happens the rear wiper will stop at its current position and will not go to park.

Adding Washer Fluid

The fluid reservoir for the windshield washers and the rear window washer (If Equipped) is shared. It is located in the front of the engine compartment on the passenger side and should be checked for fluid level at regular intervals. Fill the reservoir with windshield washer solvent (not radiator antifreeze) and operate the system for a few seconds to flush out the residual water.

TILT STEERING COLUMN

To tilt the column, push down on the lever below the multi-function control lever and move the steering wheel up or down, as desired. Pull the lever back up to lock the column firmly in place.

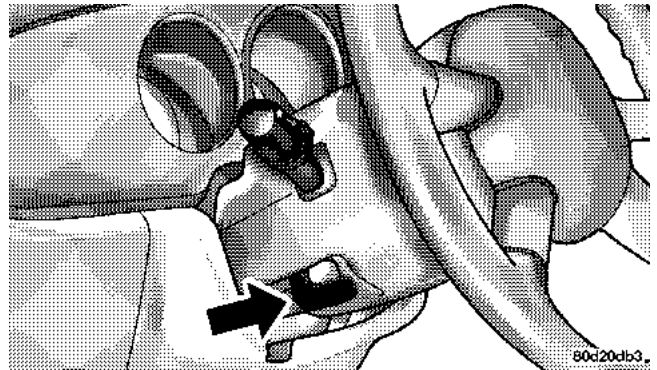

Tilt Steering Column Control

WARNING!

Tilting the steering column while the vehicle is moving is dangerous. Without a stable steering column, you could lose control of the vehicle and have an accident. Adjust the column only while the vehicle is stopped. Be sure it is locked before driving.

TRACTION CONTROL SWITCH — IF EQUIPPED

The traction control indicator, located in the instrument cluster, will flash when the Traction Control System (TCS) is in use.

The TCS switch is located on the instrument panel below the radio.

To turn the system OFF, press the TCS switch until the traction control indicator in the instrument cluster lights up.

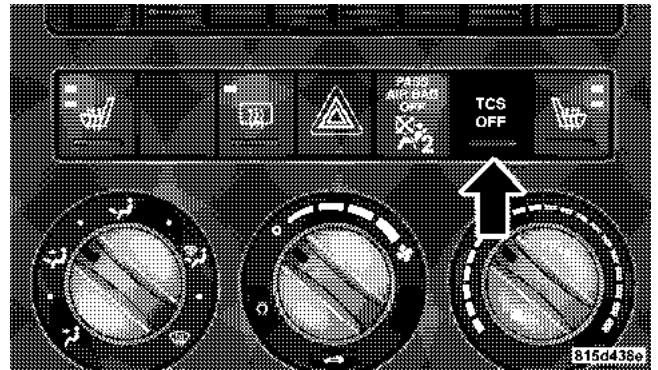

Traction Control Switch

To turn the system back ON, press the switch a second time until the traction control indicator turns OFF.

NOTE: The traction control indicator will illuminate momentarily as a bulb check, each time the ignition switch is turned ON. This will occur even if you used the TCS switch to turn the system OFF.

NOTE: The Traction Control System will make buzzing or clicking sounds when the system is in operation.

ELECTRONIC SPEED CONTROL — IF EQUIPPED

When engaged, this device takes over the accelerator operation at speeds greater than 35 mph (56 km/h). The speed control lever is located on the right side of the steering wheel.

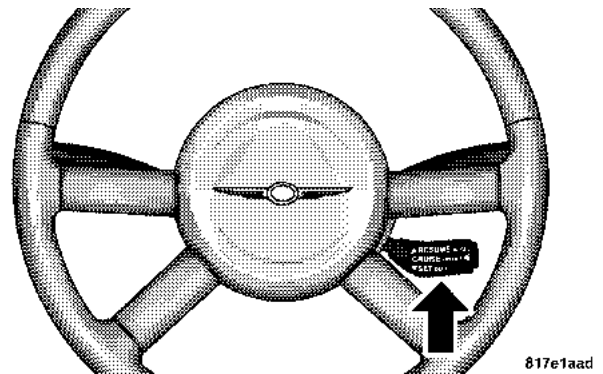

Speed Controls L or R

To Activate:

Push the ON/OFF button. The CRUISE indicator in the instrument cluster will illuminate. To turn the system OFF, push the ON/OFF button a second time. The CRUISE indicator will turn off. The system should be turned OFF when not in use.

WARNING!

Leaving the Electronic Speed Control system on when not in use is dangerous. You could accidentally set the system or cause it to go faster than you want. You could lose control and have an accident. Always leave the system OFF when you are not using it.

To Set At A Desired Speed:

When the vehicle has reached the desired speed, press down on the lever and release. Release the accelerator and the vehicle will operate at the selected speed.

NOTE: The vehicle should be traveling at a steady speed and on level ground before pressing the SET lever.

While in the AutoStick mode, speed control will only operate in third and fourth gear.

To Deactivate:

A soft tap on the brake pedal, pulling the speed control lever towards you "CANCEL", or normal brake or clutch pressure while slowing the vehicle will deactivate speed control without erasing the set speed memory. Pressing the ON/OFF button or turning off the ignition switch erases the set speed memory.

To Resume Speed:

To resume a previously set speed, push the "RESUME ACCEL" lever up and release. Resume can be used at any speed above 20 mph (32 km/h).

To Vary The Speed Setting:

When the speed control is ON, speed can be increased by pushing up and holding "RESUME ACCEL". Release the lever when the desired speed is reached, and the new speed will be set.

Tapping “RESUME ACCEL” once will result in a 2 mph (3 km/h) speed increase. Each time the lever is tapped, speed increases so that tapping the lever three times will increase speed by 6 mph (10 km/h), etc.

To decrease speed while speed control is ON, push down and hold “SET DECEL”. Release the lever when the desired speed is reached, and the new speed will be set.

Tapping the “SET DECEL” button once will result in a 1 mph (2 km/h) speed decrease. Each time the button is tapped, speed decreases.

Manual Transaxle:

Depressing the clutch pedal will disengage the speed control. A slight increase in engine RPM before the speed control disengages is normal.

Vehicles equipped with manual transaxles may need to be shifted into a lower gear to climb hills without speed loss.

WARNING!

Speed Control can be dangerous where the system can't maintain a constant speed. Your vehicle could go too fast for the conditions, and you could lose control. An accident could be the result. Don't use Speed Control in heavy traffic or on roads that are winding, icy, snow-covered, or slippery.

3

To Accelerate For Passing:

Depress the accelerator as you would normally. When the pedal is released, the vehicle will return to the set speed.

Using Speed Control On Hills

NOTE: The speed control system maintains speed up and down hills. A slight speed change on moderate hills is normal.

Vehicles equipped with four speed automatic transaxles may experience a downshift to 3rd gear while climbing uphill or descending downhill. This downshift to 3rd gear is necessary to maintain vehicle set speed.

On steep hills a greater speed loss or gain may occur so it may be preferable to drive without speed control.

GARAGE DOOR OPENER — IF EQUIPPED

NOTE: The HomeLink® system will be disabled if the Vehicle Theft Alarm (if equipped) is in the Preammed, Armed or Alarming state. The HomeLink® system will only operate when the Vehicle Theft Alarm (if equipped) is in the Disarmed mode.

The HomeLink® Universal Transceiver replaces up to three remote controls (hand held transmitters) that operate devices such as garage door openers, motorized gates, or home lighting. It triggers these devices at the

push of a button. The Universal Transceiver operates off your vehicle's battery and charging system; no batteries are needed.

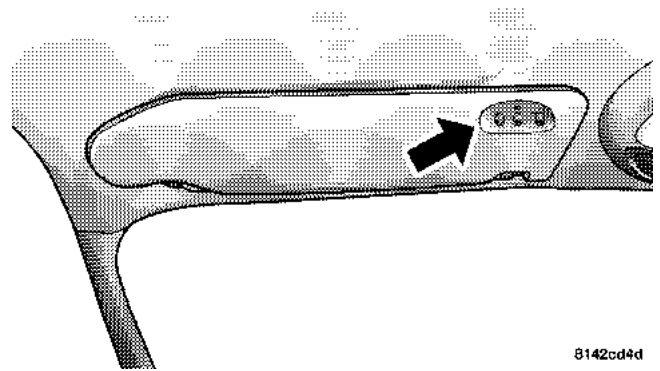

8142cd4d

HomeLink Buttons (Sedan)

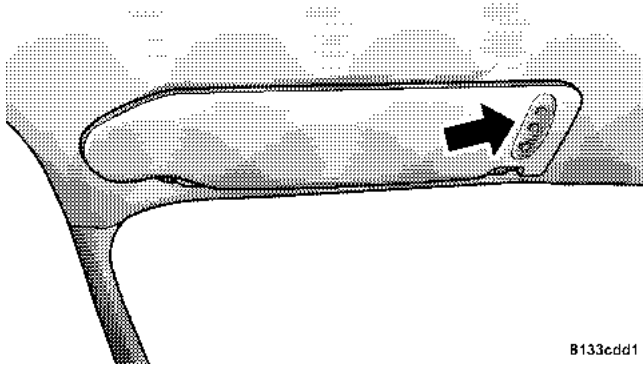

B133cdd1

HomeLink Buttons (Convertible)

For additional information on HomeLink®, call 1-800-355-3515, or on the internet at www.homelink.com.

WARNING!

A moving garage door can cause injury to people and pets in the path of the door. People or pets could be seriously or fatally injured. Only use this transceiver with a garage door opener that has a “stop and reverse” feature as required by federal safety standards. This includes most garage door opener models manufactured after 1982. Do not use a garage door opener without these safety features it could cause injury or death. Call toll-free 1-800-355-3515 or, on the Internet at www.homelink.com for safety information or assistance.

Programming The Universal Transceiver

For best results, install a new battery in the hand held transmitter before programming. If your garage door opener (located in the garage) is equipped with an antenna, make sure that the antenna is hanging straight down.

1. Turn off the engine.

WARNING!

Vehicle exhaust contains carbon monoxide, a dangerous gas. Do not run the vehicle's exhaust while training the transceiver. Exhaust gas can cause serious injury or death.

WARNING!

Your motorized door or gate will open and close while you are training the Universal Transceiver. Do not train the transceiver if people or pets are in the path of the door or gate. A moving door or gate can cause serious injury or death to people and pets or damage to objects.

2. Erase the factory test codes by pressing the two outside buttons. Release the buttons when the light in the Universal Transceiver begins to flash (about 20 seconds).

NOTE: Step 2 does not have to be followed to program additional hand held transmitters.

3. Choose one of the three Universal Transceiver buttons to program. Place the hand held controller one to three inches from the Universal Transceiver while keeping its indicator light in view.

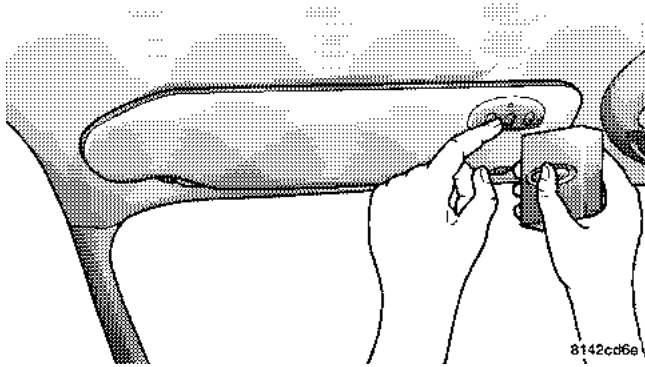

HomeLink Programming (Sedan)

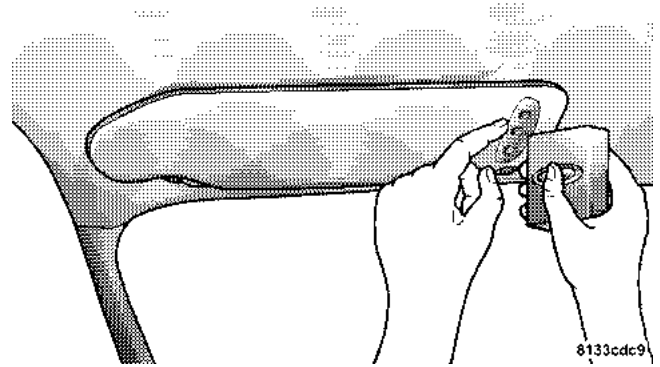

HomeLink Programming (Convertible)

4. Using both hands, press the hand held transmitter button and the desired Universal Transceiver button. Do not release the buttons until step 5 has been completed.

NOTE: Some entry gates and garage door openers may require you to replace step 4 with the procedures listed under Canadian Programming.

5. The indicator light in the Universal Transceiver will begin to flash, first slowly and then rapidly. The rapid flashing indicates successful programming. If after 90 seconds the indicator light does not flash rapidly or goes out, return to step 1 and repeat the procedure. To train the other buttons, repeat steps 3 and 4. Be sure to keep your hand held transmitters in case you need to retrain the Universal Transceiver.

NOTE: If you do not successfully program the Universal Transceiver to learn the signal of your hand held transmitter, refer to the Rolling Code Paragraph, or call toll free for customer assistance at 1-800-355-3515, or on the internet at www.homelink.com.

“Rolling Code” Programming

NOTE: If your hand held transmitter appears to program the Universal Transceiver, but your garage door or other device does not operate, and your device was

manufactured after 1996, your garage door opener or other device may have a “Rolling Code” system.

On garage door openers with the “Rolling Code” feature, the transmitter code changes after each use to prevent the copying of your code.

To check if your device is protected by a “Rolling Code” system:

- Check the owner’s manual for the device for mention of “Rolling Codes”.
- Press and hold the programmed button on the Universal Transceiver. If the Universal Transceiver indicator light flashes rapidly and then stays on after 2 seconds, the device has the “Rolling Code” feature.

To train a garage door opener (or other rolling code equipped devices) with the rolling code feature, follow these instructions **after** completing the **Programming** portion of this text:

NOTE: The assistance of a second person may make the following programming procedure quicker and easier.

1. Locate the training button on the garage door motor head unit. The exact location and color of the button may vary by garage door opener manufacturer. If you have difficulty in locating the training button, check your garage door opener manual, or call 1-800-355-3515 or, on the Internet, at www.homelink.com.

2. Press and hold the training button on the garage door opener head unit. This will activate the "training" light.

NOTE: After completing step 2, you have 30 seconds to start step 3.

3. Return to the Universal Transceiver in the vehicle and firmly press and release the garage door button. Press and release the button a second time to complete the

training process. Some garage door openers may require you to do this procedure a third time to complete the training.

Your garage door opener should now recognize your Universal Transceiver. The remaining two buttons may now be programmed if this has not previously been done. Refer to the Programming instructions. You may use either your Universal Transceiver or your original hand-held transmitter to open you garage door.

Canadian Programming/Gate Programming

Canadian frequency laws, and the technology of some entry gates, require you to press and release the hand held transmitter button every two seconds during programming.

Continue to press and hold the Universal Transceiver button while you press and release the hand held transmitter button until the frequency signal has been learned.

The Universal Transceiver light will flash slowly and then rapidly when the programming is successful.

NOTE: When programming such a garage door opener or gate, unplug the device to prevent possible damage to the garage door or gate motor.

Operation

Press and hold the desired button on the Universal Transceiver until the garage door or other device begins to operate. The light in the display shows that the signal is being transmitted. The hand held transmitter may also be used at any time.

Reprogramming A Single Button

1. Press and hold the Universal Transceiver button to be reprogrammed. Do not release until step 4 has been completed.

2. When the indicator light begins to flash slowly (after 20 seconds) position the hand held transmitter one to three inches away from the button to be trained.

3. Press and hold the hand held transmitter button.

4. The Universal Transceiver indicator light will begin to flash, first slowly, then rapidly. When the indicator lights begin to flash rapidly, release both buttons.

Security

If you sell your vehicle, be sure to erase the frequencies.

To erase all of the previously trained frequencies, hold down both outside buttons until the indicator light begins to flash.

This device complies with part 15 of FCC rules and with RS-210 of Industry Canada. Operation is subject to the following conditions:

1. This device may not cause harmful interference.

2. This device must accept any interference that may be received including interference that may cause undesired operation.

NOTE: Changes or modifications not expressly approved by the party responsible for compliance could void the user's authority to operate the equipment.

HomeLink® is a trademark owned by Johnson Controls, Inc.

POWER SUNROOF — IF EQUIPPED

The power sunroof switch is located in the reading lamp.

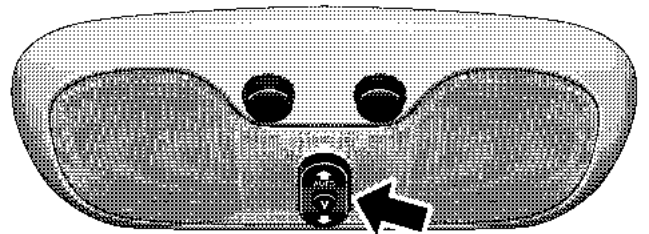

815d5564

Power Sunroof Switch

Turn the Ignition Key to the ACC or ON position, press and hold the switch rearward to fully open the sunroof. The sunroof can be stopped at any position between closed and full open. Momentarily pressing the switch rearward will activate the Express Open Feature, causing the sunroof to open automatically.

Press and hold the button in the center of the sunroof switch to open the vent. The sunroof can be stopped at any position between closed and full vent. To close the sunroof from the vent position, press and hold the switch forward. Releasing the switch will stop the movement of the sunroof and the sunroof will remain in the partial vent position until the switch is pushed forward again.

Express Open Feature

During the Express Open operation, any movement of the switch will stop the sunroof and it will remain in a partial open position. Again, momentarily pressing the switch rearward will activate the Express Open Feature.

To close the sunroof, hold the switch in the forward position. Again, any release of the switch will stop the movement and the sunroof will remain in a partial open condition until the switch is pushed forward again.

The sunshade can be opened manually. It will also open as the sunroof opens. The sunshade cannot be closed if the sunroof is open.

WARNING!

Never leave children in a vehicle, with the keys in the ignition switch. Occupants, particularly unattended children, can become entrapped by the power sunroof while operating the power sunroof switch. Such entrapment may result in serious injury or death.

WARNING!

In an accident, there is a greater risk of being thrown from a vehicle with an open sunroof. You could also be seriously injured or killed. Always fasten your seat belt properly and make sure all passengers are properly secured too.

Do not allow small children to operate the sunroof. Never allow fingers or other body parts, or any object to project through the sunroof opening. Injury may result.

Wind Buffeting

Wind buffeting can be described as the perception of pressure on the ears or a helicopter type sound in the ears. Your vehicle may exhibit wind buffeting with the windows down, or the sunroof (if equipped) in certain open or partially open positions. This is a normal occurrence and can be minimized. If the buffeting occurs with

the rear windows open, open the front and rear windows together to minimize the buffeting. If the buffeting occurs with the sunroof open, adjust the sunroof opening to minimize the buffeting or open any window.

Sunroof Maintenance

Use only a non-abrasive cleaner and a soft cloth to clean the glass panel.

ELECTRICAL POWER OUTLETS

The outlets include tethered caps, labeled with a key symbol or battery symbol, indicating power source. All outlets are protected by a single 15 Amp fuse.

The standard outlet in the front of the center floor console is a conventional cigar lighter outlet.

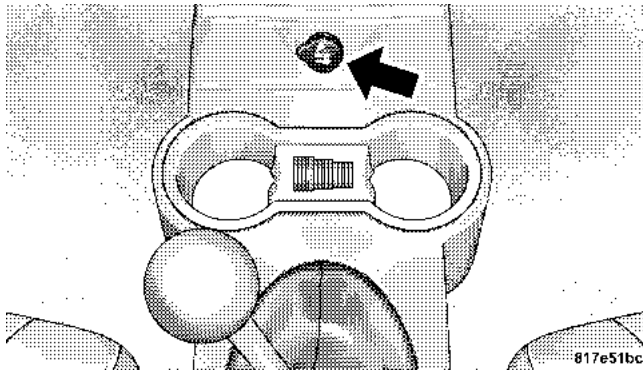

Front Power Outlet

It will accept a cigar lighter unit, which is part of the optional Smokers Package. To preserve the heating element of the cigar lighter unit, do not hold the lighter in the heating position. As a child safety precaution, this outlet is powered by the ignition switch, only when the switch is in the "ON" or "ACCESSORY" positions.

There are two optional power outlets. One is in the center console/armrest lower storage bin.

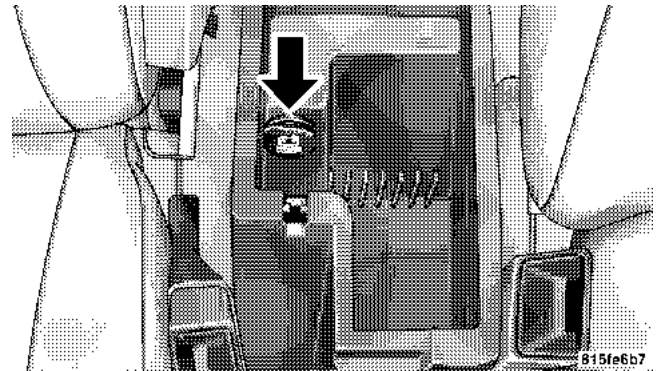

Center Console Power Outlet

This outlet is powered directly by the battery, regardless of the ignition switch position. All accessories connected to this outlet should be removed or turned off when the vehicle is not in use, to protect the battery against discharge.

The second is in the right rear cargo area.

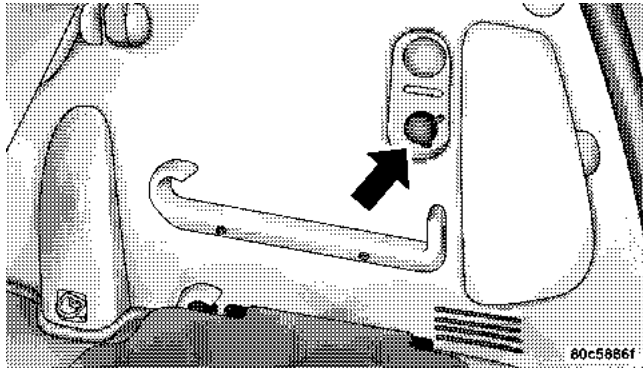

Rear Power Outlet

Since this outlet is remote from the driver, it is powered by the ignition switch, only when it is in the "ON" or "ACCESSORY" positions, to protect the battery against discharge. Note: Neither of the power outlets will accept a cigar lighter unit. They are intended only for accessory usage.

Electrical Outlet Use With Engine Off**CAUTION!**

- Many accessories that can be plugged in draw power from the vehicle's battery, even when not in use (i.e. cellular phones, etc.). Eventually, if plugged in long enough, the vehicle's battery will discharge sufficiently to degrade battery life and/or prevent engine starting.
- Accessories that draw higher power (i.e. coolers, vacuum cleaners, lights, etc.), will degrade the battery even more quickly. Only use these intermittently and with greater caution.
- After the use of high power draw accessories, or long periods of the vehicle not being started (with accessories still plugged in), the vehicle must be driven a sufficient length of time to allow the generator to recharge the vehicle's battery.

CONSOLE FEATURES

The console has two front cup holders, a removable coin holder, 12 volt power outlet and a front storage tray. There are three additional cup holders; one is molded in the center of the console to hold large cups and the others are in the rear of the console to serve passengers in the rear seat. The floor console power outlet will also operate a conventional cigar lighter unit (if equipped with an optional Smoker's Package).

CAUTION!

- Many accessories that can be plugged into the 12 volt power outlet, draw power from the vehicle's battery, even when not in use; i.e. cellular phones, etc. Eventually, if plugged in long enough, the vehicle's battery will discharge sufficiently to degrade battery life and/or prevent engine starting.
- Accessories that draw higher power such as coolers, vacuum cleaners, lights, etc., will discharge the battery even more quickly. Only use these intermittently and with greater caution.
- After the use of high power draw accessories, or long periods of the vehicle not being started, (with accessories still plugged in), the vehicle must be driven a sufficient length of time to allow the generator to recharge the vehicle's battery.

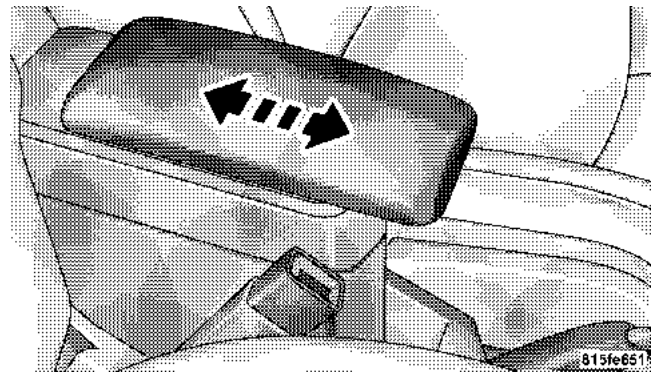
STORAGE**Center Console/Armrest Storage Bin****Sliding Armrest**

The center console provides a sliding armrest with two unique storage compartments under the lid.

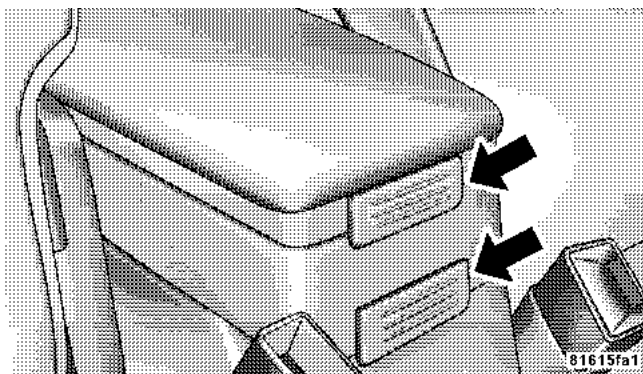

Sliding Armrest Storage Bins

Push the upper button on the front of the armrest to raise the upper cover. Inside is a slot for a power cord, an area to store a cell phone, and other miscellaneous items. Push the lower button on the front of the armrest, and raise the armrest for access to the lower storage bin. The lower storage has a power outlet (if equipped), a slot for a power cord, and can be used for storing up to six CD's and other miscellaneous items.

CAUTION!

- Many accessories that can be plugged in draw power from the vehicle's battery, even when not in use (i.e. cellular phones, etc.). Eventually, if plugged in long enough, the vehicle's battery will discharge sufficiently to degrade battery life and/or prevent engine starting.
- Accessories that draw higher power (i.e. coolers, vacuum cleaners, lights, etc.), will degrade the battery even more quickly. Only use these intermittently and with greater caution.
- After the use of high power draw accessories, or long periods of the vehicle not being started (with accessories still plugged in), the vehicle must be driven a sufficient length of time to allow the generator to recharge the vehicle's battery.

Storage Pockets

There are also Storage pockets located on each door trim panel.

REAR SHELF PANEL— IF EQUIPPED

The rear shelf panel attaches to guides in the rear cargo area. The rear shelf panel may be installed in one of five different positions.

NOTE: The liftgate may be opened or closed with the rear cargo shelf panel in position 1, position 2, position 3 or position 4.

WARNING!

- To avoid tipping, lock the shelf securely in all positions.
- Do not drive this vehicle with the liftgate open, or use the shelf as a seat.
- Failure to follow these warnings could result in serious or fatal injury.

Position 1 (Top)

Insert the front outboard corners of the shelf panel into the top guides and slide forward. Press down on the back of the shelf panel to lock it into place.

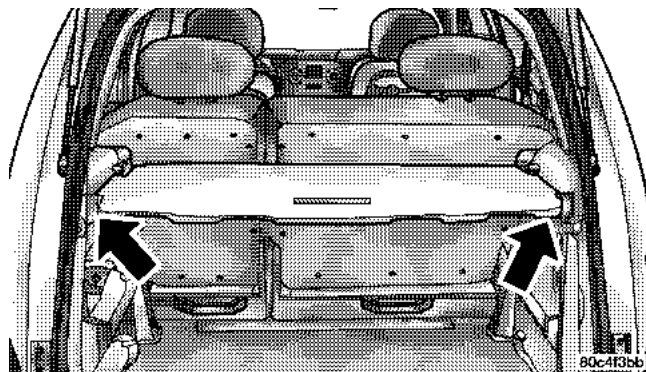

Rear Shelf Panel Position 1

WARNING!

Do not load objects on the shelf in position 1 (top). In an accident objects could strike occupants causing serious or fatal injury.

Position 2 (Middle)

Insert the front outboard corners of the shelf panel into the middle guides and slide forward. Press down on the back of the shelf panel to lock it into place.

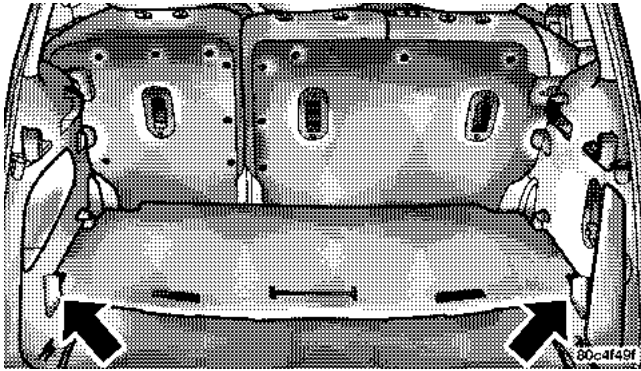

Rear Shelf Panel Position 2

WARNING!

Do not load objects over 100 lbs (45 kg) in position 2 (middle). Failure to follow this warning could cause the shelf to collapse resulting in personal injury.

3**Position 3 (Floor)**

Insert the front outboard corners of the shelf panel into the bottom guides and slide forward.

NOTE: To carry items that may soil the carpeting, the rear shelf panel may be inverted in position 2 or position 3.

Position 4 (Vertical)

Insert the front outboard corners of the shelf panel into the vertical guides behind the rear seatbacks near the floor and slide downward. Push the shelf panel forward to lock it into place.

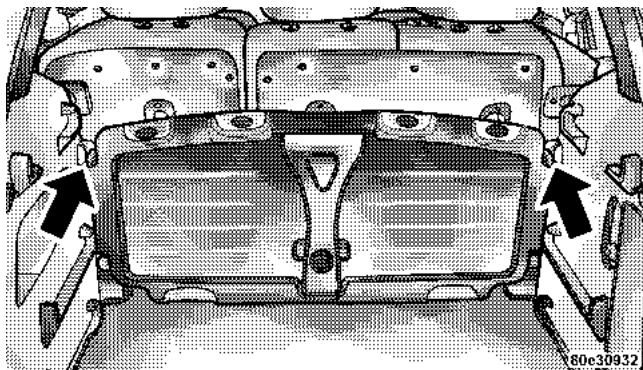

Rear Shelf Panel Position 4

WARNING!

When in the vertical position, the rear shelf panel should not be used as a barrier for large objects in the cargo area when the seatbacks folded down. In an accident objects could strike the seatbacks or occupants causing serious or fatal injury.

Position 5 (table)

With the liftgate open the rear shelf panel can be moved rearward to act as a serving counter.

1. Install the front corners of the shelf panel into the top rear guides. Press down on the shelf panel to lock it into place.

2. Twist the knob on the underside of the panel and lower the shelf leg.

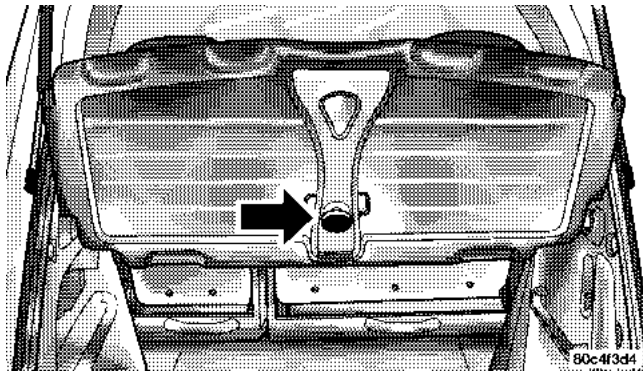

Rear Shelf Leg Release Knob

3. Install the shelf leg into the liftgate latch area as labeled on the rear scuff plate.

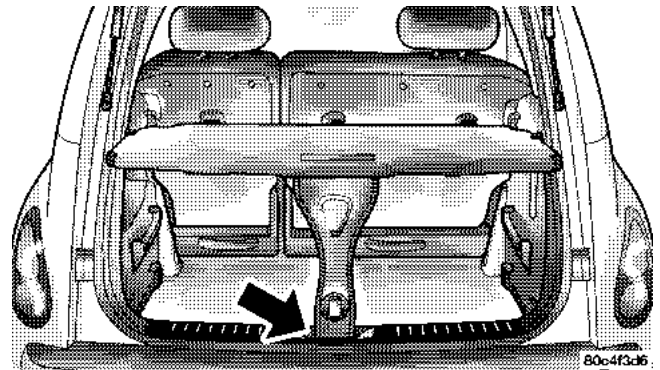

Rear Shelf Panel Position 5

3

WARNING!

Do not load objects over 100 lbs (45 kg) in position 5 (table). Failure to follow this warning could cause the shelf to collapse resulting in personal injury.

ROOF LUGGAGE RACK — IF EQUIPPED

The crossbars and siderails are designed to carry the weight on vehicles equipped with a luggage rack. The load must not exceed 150 lbs (68 kg), and should be uniformly distributed over the luggage rack crossbars.

Use both adjustable crossbars assemblies to support the load and distribute the load as evenly as possible.

To adjust the crossbars with latch style releases, release the latches on the inboard side of the crossbar supports on each side of the vehicle, then move the crossbars to the desired position. Once the crossbar is in the desired position, return both latches to the locked position.

To adjust the crossbars with button style releases, depress the button and slide the crossbar to the next locking position. Alternate sides until the crossbars are positioned correctly for your cargo and the stanchions are locked square to the slide rails.

External racks do not increase the total load carrying capacity of the vehicle. Be sure that the total occupant and luggage load inside the vehicle, plus the load on the luggage rack, do not exceed the rated vehicle capacity.

NOTE: When the luggage rack is not in use, place the crossbars together at the rear of the vehicle. In this position they are designed to improve the vehicle aerodynamics and reduce wind noise.

CAUTION!

To avoid damage to the roof rack and vehicle, do not exceed the maximum roof rack load capacity of 150 lbs (68 kg). Always distribute heavy loads as evenly as possible and secure the load appropriately.

Long loads which extend over the windshield, such as wood panels or surfboards, should be secured to both the front and rear of the vehicle.

Travel at reduced speeds and turn corners carefully when carrying large or heavy loads on the roof rack. Wind forces, due to natural causes or nearby truck traffic, can add sudden upward loads. This is especially true on large flat loads and may result in damage to the cargo or your vehicle.

WARNING!

Cargo must be securely tied before driving your vehicle. Improperly secured loads can fly off the vehicle, particularly at high speeds, resulting in personal injury or property damage. Follow the roof rack "Cautions" when carrying cargo on your roof rack.

UNDERSTANDING YOUR INSTRUMENT PANEL

CONTENTS

■ Instrument Panel Features	218	□ Average Fuel Economy	232
■ Instrument Cluster—Base	219	□ Distance To Empty (DTE)	232
■ Instrument Cluster—Premium	220	□ Elapsed Time	232
■ Instrument Cluster—Turbo	221	□ Personal Settings (Customer Programmable Features)	232
■ Instrument Cluster Descriptions	222	■ Setting The Analog Clock	238
■ Electronic Vehicle Information Center (EVIC)—If Equipped	229	■ Radio General Information	239
□ EVIC Functions	231	□ Radio Broadcast Signals	239
□ Compass/Temperature/Audio	231	□ Two Types Of Signals	239

216 UNDERSTANDING YOUR INSTRUMENT PANEL

□ Electrical Disturbances	239	■ Sales Code RAQ – AM/FM/CD (6-Disc) Radio With Optional Satellite Radio, Hands Free Phone, And Vehicle Entertainment Systems (VES) Capabilities	248
□ AM Reception	239	□ Operating Instructions - Radio Mode	248
□ FM Reception	239	□ Operation Instructions - (CD Mode For CD Audio Play)	254
■ Sales Code REF — AM/FM/CD (Single Disc) Radio With Optional Satellite Radio And Hands Free Phone Capability	240	□ Load/Eject Button (CD Mode For CD Audio Play)	255
□ Operating Instructions - Radio Mode	240	□ Notes On Playing MP3 Files	257
□ Operation Instructions - CD Mode	244	□ Operation Instructions - (CD Mode For MP3 Audio Play)	259
□ Operation Instructions - Auxiliary Mode	246	□ Load/Eject Button (CD Mode For MP3 Play)	259
□ Operating Instructions - Hands Free Phone — If Equipped	247	■ Satellite Radio — If Equipped	261
□ Operating Instructions - Satellite Radio — If Equipped	248	□ System Activation	262

□ Electronic Serial Number/Sirius Identification Number (ESN/SID)	262	□ Reception Quality	265
□ Selecting Satellite Mode In REF, And RAQ, Radios	263	■ CD/DVD Disc Maintenance	265
□ Selecting a Channel	263	■ Radio Operation And Cellular Phones	266
□ Storing And Selecting Pre-Set Channels	264	■ Climate Controls	266
□ Using The PTY (Program Type) Button (If Equipped)	264	□ Climate Controls	266
□ PTY Button "Scan"	264	□ Operating Tips	271
□ PTY Button "Seek"	264	■ Rear Window Features	273
□ Satellite Antenna	265	□ Electric Rear Window Defroster	273
		□ Rear Wiper/Washer Switch — If Equipped	274
		□ Adding Washer Fluid	275

INSTRUMENT PANEL FEATURES

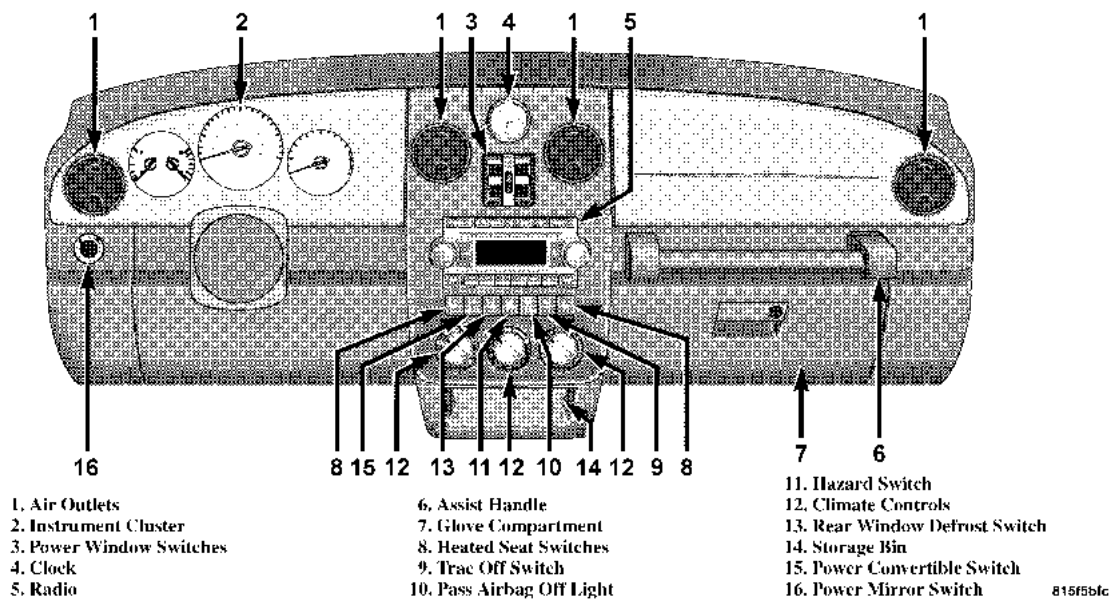

INSTRUMENT CLUSTER—BASE

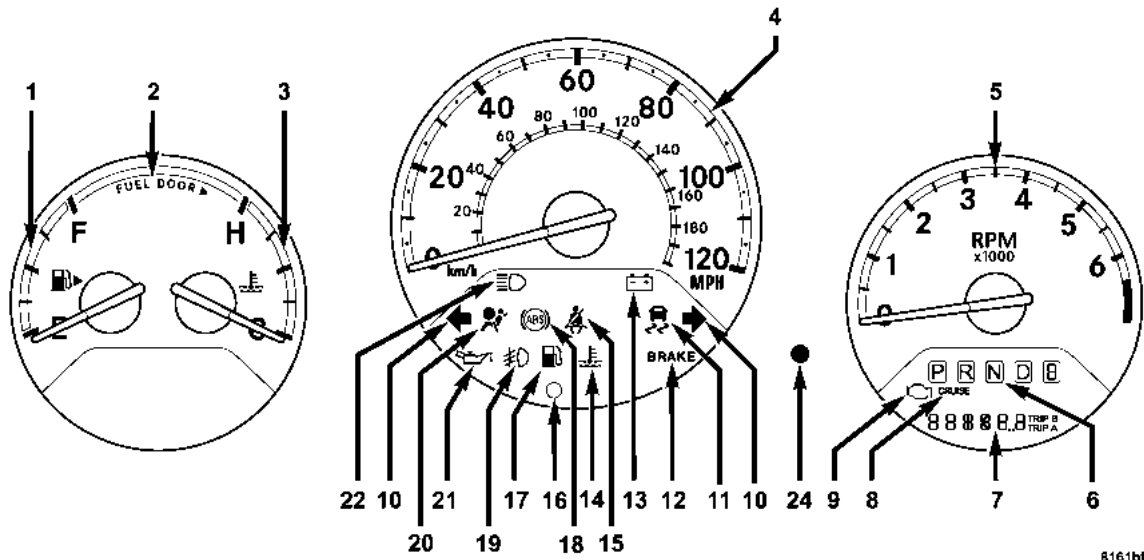

8161bf4b

INSTRUMENT CLUSTER—PREMIUM

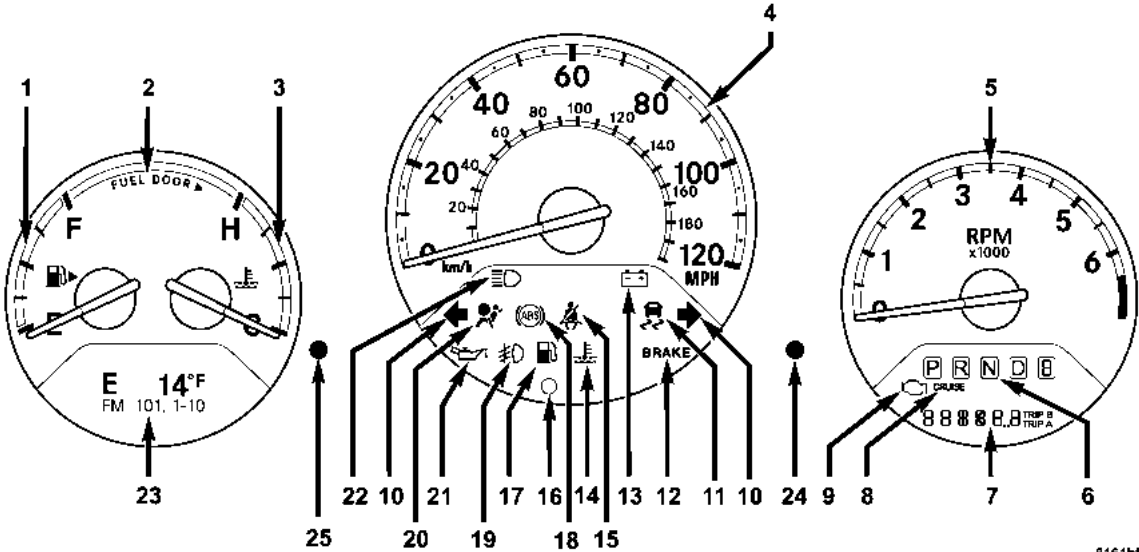

INSTRUMENT CLUSTER—TURBO

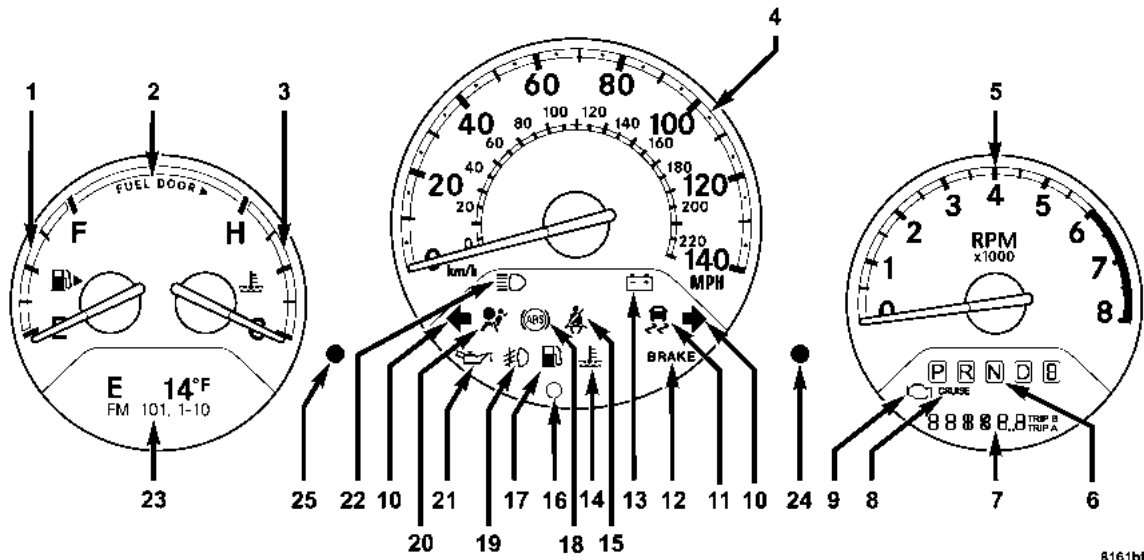

8161bf5c

INSTRUMENT CLUSTER DESCRIPTIONS**1. Fuel Gauge**

 When the ignition switch is in the ON position, the pointer will show the level of fuel remaining in the fuel tank.

2. Fuel Door Reminder

This is a reminder that the Fuel Filler Door is located on the front passenger's (right) side of the vehicle.

3. Temperature Gauge

 The temperature gauge shows engine coolant temperature. Any reading below the red area of the gauge shows that the engine cooling system is operating properly. The gauge pointer may show a higher than normal temperature when driving in hot weather, up mountain grades, in heavy stop and go traffic, or when towing a trailer.

If the pointer rises to the **H** (red) mark, the instrument cluster will sound a chime. Pull over and stop the vehicle. Idle the vehicle with the air conditioner turned off until the pointer drops back into the normal range. If the pointer remains on the **H** (red) mark, turn the engine off immediately and call for service.

There are steps that you can take to slow down an impending overheat condition. If your air conditioning is on, turn it off. The air conditioning system adds heat to the engine cooling system and turning off the A/C removes this heat. You can also turn the Temperature control to maximum heat, the Mode control to Floor and the Fan control to High. This allows the heater core to act as a supplement to the radiator and aids in removing heat from the engine cooling system.

4. Speedometer

Indicates vehicle speed.

5. *Tachometer*

The white area of the scale shows the permissible engine revolutions-per-minute (rpm x 1000) for each gear range. Before reaching the red area, ease up on the accelerator to prevent engine damage.

6. *Transmission Range Indicator*

This display indicator shows the automatic transmission gear selection.

7. *Odometer/Trip Odometer*

A vacuum fluorescent display indicates the total distance the vehicle has been driven. Also, the cluster will display, replacing the odometer/trip odometer, vehicle warning messages such as: door/deck/hatch/gate ajar and loose gas cap. Loose gas cap will be displayed from the Odometer/Trip Odometer on all models.

NOTE: If vehicle is equipped with the optional Electronic Vehicle Information Center (EVIC) in the instrument cluster, all warnings including “door”, “dEck”,

“hATCh”, and “gATE” will only be displayed in the EVIC display. For additional information, refer to “Electronic Vehicle Information Center — If Equipped” in Section 3.

U.S. federal regulations require that upon transfer of vehicle ownership, the seller certify to the purchaser the correct mileage that the vehicle has been driven. Therefore, if the odometer reading is changed during repair or replacement, be sure to keep a record of the reading before and after the service so that the correct mileage can be determined.

8. *Cruise Indicator — If Equipped*

CRUISE This indicator shows that the Speed Control System is ON. (See page 189 for more information.)

NOTE: The word “SET” **will not** illuminate when the Speed Control System is on.

9. Malfunction Indicator Light



This light is part of an onboard diagnostic system called OBD that monitors emissions, engine, and automatic transmission control systems. The light will illuminate when the key is in the ON/RUN position before engine start. If the bulb does not come on when turning the key from OFF to ON/RUN, have the condition checked promptly.

Certain conditions such as a loose or missing gas cap, poor fuel quality, etc. may illuminate the light after engine start. The vehicle should be serviced if the light stays on through several of your typical driving cycles. In most situations the vehicle will drive normally and will not require towing.

If the Malfunction Indicator Light flashes when the engine is running, serious conditions may exist that could lead to immediate loss of power or severe catalytic

converter damage. The vehicle should be serviced as soon as possible if this occurs. (See page 364 for more information.)

10. Turn Signal Indicators



The arrows will flash in unison with the exterior turn signal, when using the turn signal lever.

NOTE: Turn signal bulbs are located in the Instrument Panel. (See page 183 for more information.)

11. Electronic Stability Program (ESP) Indicator Light/Traction Control System (TCS) Indicator Light — If Equipped



If this indicator light flashes during acceleration, apply as little throttle as possible. While driving, ease up on the accelerator. Adapt your speed and driving to the prevailing road conditions, and do not switch off the ESP, or TCS — if equipped. (See page 300 for more information.)

12. Brake System Warning Light

This light monitors various brake functions, including brake fluid level and parking brake application. If the brake light turns on, it may indicate that the parking brake is applied, there is a low brake fluid level or there is a problem with the anti-lock brake system.

The dual brake system provides a reserve braking capacity in the event of a failure to a portion of the hydraulic system. Failure of either half of the dual brake system is indicated by the Brake Warning Light which will turn on when the brake fluid level in the master cylinder has dropped below a specified level.

The light will remain on until the cause is corrected.

NOTE: The light may flash momentarily during sharp cornering maneuvers which change fluid level conditions. The vehicle should have service performed, and the brake fluid level checked.

If brake failure is indicated, immediate repair is necessary.

WARNING!

Driving a vehicle with the brake light on is dangerous. Part of the brake system may have failed. It will take longer to stop the vehicle. You could have an accident. Have the vehicle checked immediately.

Vehicles equipped with Anti-Lock brakes (ABS), are also equipped with Electronic Brake Force Distribution (EBD). In the event of an EBD failure, the Brake Warning Light will turn on along with the ABS Light. Immediate repair to the ABS system is required.

The operation of the Brake Warning Light can be checked by turning the ignition switch from the OFF position to

the ON position. The light should illuminate for approximately two seconds. The light should then turn off unless the parking brake is applied or a brake fault is detected. If the light does not illuminate, have the light inspected by an authorized dealer.

The light also will turn on when the parking brake is applied with the ignition switch in the ON position.

NOTE: This light shows only that the parking brake is applied. It does not show the degree of brake application.

13. Charging System Light

 This light shows the status of the electrical charging system. The light should come on briefly when the ignition switch is first turned ON and remain on briefly as a bulb check. If the light stays on or comes on while driving, it means that there is a problem with the charging system. Obtain SERVICE IMMEDIATELY.

14. Engine Temperature Warning Light



This light warns of an overheated engine condition. If the engine is critically hot, a warning chime will sound 10 times. After the chime turns off, the engine will still be critically hot until the light goes out.

15. Seat Belt Reminder Light



When the ignition switch is first turned ON, this light will come on for about six seconds. A chime will sound if you have not pulled the shoulder belt out of the retractor. This is a reminder to “buckle up”. If you do not buckle up, the light will remain on.

16. Theft Alarm Light — If Equipped

This light will flash rapidly for several seconds when the alarm system is arming. The light will begin to flash slowly indicating that the system is armed. (See page 36 for more information.)

17. Low Fuel Light

When the fuel level drops to 2 gallons, the fuel symbol will light and a single chime will sound.

18. Anti-Lock Warning Light (ABS) — If Equipped

This light monitors the Anti-Lock Brake System (ABS) described elsewhere in this manual. This light will come on when the ignition key is turned to the ON position and may stay on for

as long as four seconds.

If the ABS light remains on or comes on during driving, it indicates that the Anti-Lock portion of the brake system is not functioning and that service is required, however, the conventional brake system will continue to operate normally provided that the BRAKE warning light is not on.

If the ABS light is on, the brake system should be serviced as soon as possible to restore the benefit of Anti-Lock Brakes.

The warning light should be checked frequently to assure that it is operating properly. Turn the ignition key to the on position, but do not start the vehicle. The light should come on. If the light does not come on, have the system checked by an authorized dealer.

19. Front Fog Light Indicator — If Equipped

This light shows when the front fog lights are ON. (See page 183 for more information.)

4

20. Airbag Light

The light comes on and remains on for 6 to 8 seconds as a bulb check when the ignition switch is first turned ON. If the light does not come on during starting, stays on, or comes on while driving, have the system checked by an authorized dealer. (See page 103 for more information.)

21. Oil Pressure Light

Shows low engine oil pressure. The light will come on and remain on when the ignition switch is

turned from the OFF to the ON position, and the light will turn off after the engine is started. If the bulb does not come on during starting, have the system checked by an authorized dealer.

If the light comes on and remains on while driving, stop the vehicle and shut off the engine. **DO NOT OPERATE THE VEHICLE UNTIL THE CAUSE IS CORRECTED.**

The light does not show the quantity of oil in the engine. This can be determined using the procedure shown in Section 7. (See page 368 for more information.)

22. High Beam Indicator

 This light shows that the headlights are on high beam. Pull the turn signal lever toward the steering wheel to switch the headlights from high or low beam.

23. Electronic Vehicle Information Center Display—If Equipped

When the appropriate conditions exist, this display shows the Electronic Vehicle Information Center (EVIC) messages. (See page 229 for more information.)

24. Odometer/Trip Odometer Reset Knob

Press this button to change the display from odometer to either of the two trip odometer settings. Trip A or Trip B will appear when in the trip odometer mode. Push in and hold the button for two seconds to reset the trip odometer to 0 miles or kilometers. The odometer must be in trip mode to reset.

25. Electronic Vehicle Information Center (EVIC) Button—If Equipped

Pushing this button will switch between the different EVIC functions. (See page 229 for more information.)

ELECTRONIC VEHICLE INFORMATION CENTER (EVIC)—If Equipped

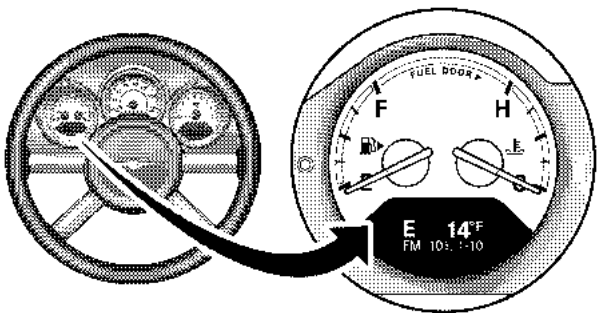

816415d1

EVIC Location

The Electronic Vehicle Information Center (EVIC) features a driver-interactive display. It is located in the lower left part of the cluster below the fuel and engine temperature gauge. The EVIC consists of the following:

- System Status
- Vehicle information warning message displays
- Personal Settings (customer programmable features)
- Compass heading
- Outside temperature display
- Trip computer functions
- UConnect™ hands-free communication system displays — If Equipped
- Audio mode display

When the appropriate conditions exist, the Electronic Vehicle Information Center (EVIC) displays the following messages.

- Turn Signal On (with a continuous warning chime)
- Left Front Turn Signal Lamp Out (with a single chime)

230 UNDERSTANDING YOUR INSTRUMENT PANEL

- Left Rear Turn Signal Lamp Out (with a single chime)
- Right Front Turn Signal Lamp Out (with a single chime)
- Right Rear Turn Signal Lamp Out (with a single chime)
- RKE Battery Low (with a single chime)
- Personal Settings Not Available – Vehicle Not in Park (automatic transmissions) or vehicle is in motion (manual transmissions).
- Left/Right Front Door Ajar (one or more, with a single chime if speed is above 1 mph)
- Left/Right Rear Door Ajar (one or more, with a single chime if speed is above 1 mph)
- Door (S) Ajar (with a single chime if vehicle is in motion)
- Trunk Ajar (with a single chime)
- Low Washer Fluid (with a single chime)
- Headlamps On
- Key In Ignition

EVIC Functions

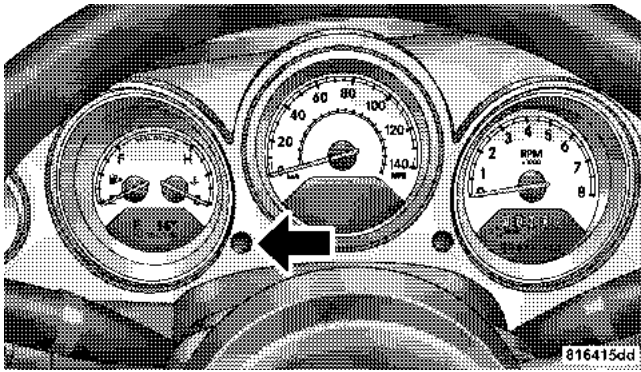

EVIC Button

Press the EVIC button until one of the following functions are displayed on the EVIC:

- Compass/Temperature/Audio
- Average Fuel Economy

- Distance To Empty (DTE)
- Elapsed Time
- Personal Settings

To Reset The Display

Pressing and holding the EVIC button once will clear the resettable function currently being displayed. Reset will only occur if a resettable function is currently being displayed. To reset all resettable functions, press and release the EVIC button a second time within 3 seconds of resetting the currently displayed function (Reset ALL will be displayed during this 3 second window).

Compass/Temperature/Audio

Press and release the EVIC button to display one of eight compass headings to indicate the direction the vehicle is facing, the outside temperature and the current radio station.

For additional information regarding the compass, refer to Personal Settings (Customer Programmable Features) in this section.

Average Fuel Economy

Shows the average fuel economy since the last reset. When the fuel economy is reset, the display will read "RESET" or show dashes for two seconds. Then, the history information will be erased, and the averaging will continue from where it was before the reset.

Distance To Empty (DTE)

Shows the estimated distance that can be travelled with the fuel remaining in the tank. This estimated distance is determined by a weighted average of the instantaneous and average fuel economy, according to the current fuel tank level. This is not resettable.

NOTE: Significant changes in driving style or vehicle loading will greatly affect the actual drivable distance of the vehicle, regardless of the DTE displayed value.

When the DTE value is less than 30 miles estimated driving distance, the DTE display will change to a text display of "LOW FUEL". This display will continue until the vehicle runs out of fuel. Adding a significant amount of fuel to the vehicle will turn off the "LOW FUEL" text and a new DTE value will be displayed, based on the current values in the DTE calculation and the current fuel tank level.

Elapsed Time

Shows the total elapsed time of travel since the last reset when the ignition switch is in the ACC position. Elapsed time will increment when the ignition switch is in the ON or START position.

Personal Settings (Customer Programmable Features)

This allows the driver to set and recall features when the transmission is in PARK (automatic transmission) or the vehicle is stopped (manual transmissions).

Press and release the EVIC button until Personal Settings is displayed in the EVIC.

Use the EVIC button to display one of the following choices:

Language

When in this display you may select different languages for all display nomenclature, including the trip functions. Pressing the EVIC button while in this display selects English, Espanol, Deutsch, Italiano, or Francais depending on availability. As you continue the displayed information will be shown in the selected language.

NOTE: UConnect™ language will not change using the EVIC. Please refer to “Language Selection” in the HANDS-FREE COMMUNICATION (UConnect™) — IF EQUIPPED section of this manual for details.

Lock Doors Automatically at 15 MPH (24 Km/h)

When ON is selected all doors lock automatically when the speed of the vehicle reaches 15 mph (24 km/h). Press and hold the EVIC button when in this display until “ON” or “OFF” appears to make your selection.

Auto Unlock On Exit

When ON is selected all the vehicle’s doors will unlock when the driver’s door is opened if the vehicle is stopped (manual transmissions) or the vehicle is stopped and the transmission is in P (Park) or N (Neutral) position (automatic transmissions). Press and hold the EVIC button when in this display until “ON” or “OFF” appears to make your selection.

Remote Unlock Driver’s Door 1st

When **DRIVER’S DOOR 1ST** is selected only the driver’s door will unlock on the first press of the remote keyless entry unlock button and require a second press to unlock the remaining locked doors. When **REMOTE**

UNLOCK ALL DOORS is selected all of the doors will unlock at the first press of the remote keyless entry unlock button. Press and hold the EVIC button when in this display until "DRIVER'S DOOR 1ST" or "ALL DOORS" appears to make your selection.

Sound Horn with Remote Key Lock

When ON is selected a short horn sound will occur when the remote keyless entry "Lock" button is pressed. This feature may be selected with or without the flash lights on lock/unlock feature. Press and hold the EVIC button when in this display until "ON" or "OFF" appears to make your selection.

Flash Lights with Remote Key Lock

When ON is selected, the front and rear turn signals will flash when the doors are locked or unlocked using the remote keyless entry transmitter. This feature may be selected with or without the sound horn on lock feature

selected. Press and hold the EVIC button when in this display until "ON" or "OFF" appears to make your selection.

Delay Turning Headlamps Off

When this feature is selected the driver can choose to have the headlamps remain on for 0, 30, 60, or 90 seconds when exiting the vehicle. Press and hold the EVIC button when in this display until 0, 30, 60, or 90 appears to make your selection.

Headlamps On With Wipers (Available with Auto Headlights Only)

When ON is selected and the headlight switch is in the AUTO position, the headlights will turn on approximately 10 seconds after the wipers are turned on. The headlights will also turn off when the wipers are turned off if they were turned on by this feature. Press and hold the EVIC button when in this display until "ON" or "OFF" appears to make your selection.

NOTE: Turning the headlights on during the daytime causes the instrument panel lights to dim. To increase the brightness, refer to “Lights” in this section.

Delay Power Off to Accessories Until Exit

When this feature is selected, the power window switches, radio, hands-free system, DVD video system, power sunroof, and power outlets will remain active for up to 60 minutes after the ignition switch has been turned off. Opening a vehicle door will cancel this feature. Press and hold the EVIC button when in this display until “Off”, “45 sec.”, “5 min.”, or “10 min.” appears to make your selection.

Turn Headlamps on with Remote Key Unlock

When this feature is selected the headlamps will activate and remain on for up to 90 seconds when the doors are unlocked using the remote keyless entry transmitter.

Press and hold the EVIC button when in this display until “OFF”, “30 sec.”, “60 sec.”, or “90 sec.” appears to make your selection.

Confirmation of Voice Commands — If Equipped

When ON is selected all voice commands from the U-Connect system are confirmed. Press and hold the EVIC button when in this display until “ON” or “OFF” appears to make your selection.

Display English or Metric

The EVIC, odometer, and navigation system units can be changed between English and Metric.

Press and hold the EVIC button when in this display until “US” or “METRIC” appears to make your selection.

Compass Variance

Compass Variance is the difference between magnetic North and Geographic North. In some areas of the country, the difference between magnetic and geographic

North is great enough to cause the compass to give false readings. In order to ensure compass accuracy, the compass variance should be properly set according to the compass variance map zone that the vehicle is in.

NOTE: Magnetic materials should be kept away from the Instrument Panel. This is where the compass sensor is located.

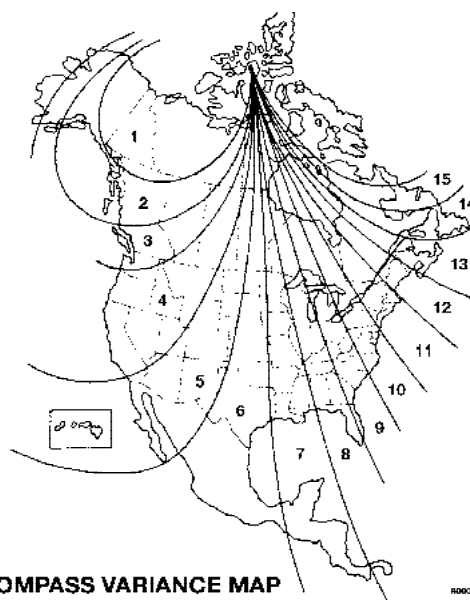

To set the variance: with the ignition in the ON position, with a short button press (less than one seconds) press and release the EVIC button several times until you have displayed the Personal Settings (Customer Programmable Features) menu. Once in the Personal Settings (Customer Programmable Features) menu, press and release (less than one seconds) the EVIC button several times until “Compass Variance” is highlighted. The “Compass Variance” message and the current variance zone number will be displayed. To change the zone, press and hold (longer than two seconds) the EVIC button to increment the variance one step. Repeat as necessary, with individual long (longer than two seconds) EVIC button presses for each increment, until the desired variance is achieved. To exit the Variance Programming, press the EVIC button with a short (less than one second) button press.

NOTE: The factory default Zone is 8. During programming, the Zone value will wrap around from Zone 15 to Zone 1.

Compass Calibration

If the compass appears erratic, inaccurate or abnormal, you may wish to calibrate the compass. Prior to calibrating the compass make sure the proper zone is selected.

To manually calibrate the Compass: start the engine and leave the transmission in the PARK position. With a short button press (less than one second) press and release the EVIC button several times until the EVIC displays the Personal Settings (Customer Programmable Features) menu. Once in the Personal Settings (Customer Programmable Features) menu, press and release (less than one second) the EVIC button several times until “Calibrate Compass (Yes)” is displayed. A long (longer than two seconds) EVIC button Press will place the Compass in

calibration mode. The Cal indicator will come on continuously in the EVIC display to indicate that the compass is now in the calibration mode and that the vehicle can now be driven to calibrate. (A short EVIC button press from the "Calibrate Compass (Yes)" screen will exit the EVIC Customer Programmable features, and return it to its normal operating mode). To complete the compass calibration, drive the vehicle in one or more complete 360 degree circles under 5 mph (8 km/h) in an area free from power lines, large metallic objects, until the CAL indicator turns off. The compass will now function normally.

SETTING THE ANALOG CLOCK

To set the analog clock at the top center of the instrument panel, press and hold the button until the setting is correct. The clock will adjust slowly at first and then quicker the longer the button is held.

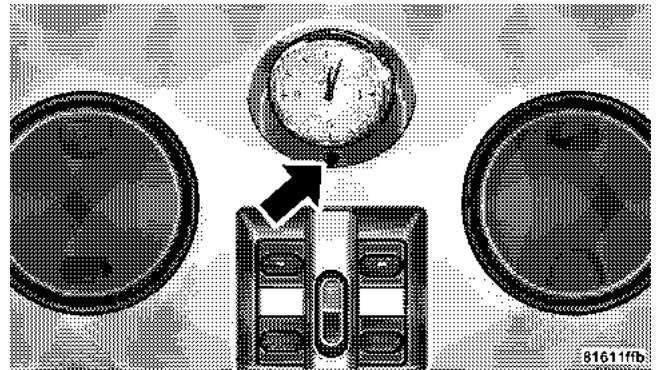

Setting The Analog Clock

RADIO GENERAL INFORMATION

Radio Broadcast Signals

Your new radio will provide excellent reception under most operating conditions. Like any system, however, car radios have performance limitations, due to mobile operation and natural phenomena, which might lead you to believe your sound system is malfunctioning. To help you understand and save you concern about these “apparent” malfunctions, you must understand a point or two about the transmission and reception of radio signals.

Two Types of Signals

There are two basic types of radio signals... AM or Amplitude Modulation, in which the transmitted sound causes the amplitude, or height, of the radio waves to vary... and FM or Frequency Modulation, in which the frequency of the wave is varied to carry the sound.

Electrical Disturbances

Radio waves may pick up electrical disturbances during transmission. They mainly affect the wave amplitude, and thus remain a part of the AM reception. They interfere very little with the frequency variations that carry the FM signal.

AM Reception

AM sound is based on wave amplitude, so AM reception can be disrupted by such things as lightning, power lines and neon signs.

FM Reception

Because FM transmission is based on frequency variations, interference that consists of amplitude variations can be filtered out, leaving the reception relatively clear, which is the major feature of FM radio.

NOTE: On vehicles so equipped the radio, steering wheel radio controls and 6 disc CD/DVD changer will

240 UNDERSTANDING YOUR INSTRUMENT PANEL

remain active for up to 45 seconds after the ignition switch has been turned off. Opening a vehicle front door will cancel this feature.

SALES CODE REF — AM/FM/CD (SINGLE DISC) RADIO WITH OPTIONAL SATELLITE RADIO AND HANDS FREE PHONE CAPABILITY

NOTE: The radio sales code is located on the lower right side of your radio faceplate.

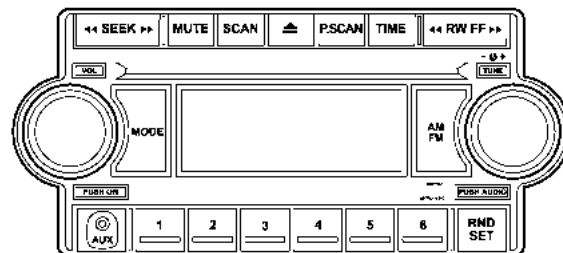

815eb156

REF Radio

Operating Instructions - Radio Mode

NOTE: The ignition switch must be in the ON or ACC position to operate the radio.

Power Switch/Volume Control (Rotary)

Press the ON/VOL control to turn the radio ON. Press the ON/VOL a second time to turn OFF the radio.

Electronic Volume Control

The electronic volume control turns continuously (360 degrees) in either direction without stopping. Turning the volume control to the right increases the volume and to the left decreases it.

When the audio system is turned on, the sound will be set at the same volume level as last played.

For your convenience, the volume can be turned down, but not up, when the audio system is off and the ignition is ON.

Mode Button (Radio Mode)

Press the mode button repeatedly to select between the CD player or Satellite Radio (if equipped).

SEEK Button (Radio Mode)

Press and release the SEEK button to search for the next listenable station in either AM/FM or Satellite (if equipped) mode. Press the right side of the button to seek up and the left side to seek down. The radio will remain tuned to the new station until you make another selection. Holding the button will bypass stations without stopping until you release it.

MUTE Button (Radio Mode)

Press the MUTE button to cancel the sound from the speakers. "MUTE" will be displayed. Press the MUTE button a second time and the sound from the speakers will return. Rotating the volume control, turning the radio ON/OFF, or turning ON/OFF the ignition, will cancel the MUTE feature.

NOTE: In Hands Free Phone (if equipped) mode, the MUTE button mutes the microphone.

SCAN Button (Radio Mode)

Pressing the SCAN button causes the tuner to search for the next listenable station, in either AM, FM or Satellite (if equipped) frequencies, pausing for 5 seconds at each listenable station before continuing to the next. To stop the search, press SCAN a second time.

PSCAN Button (Radio Mode)

Pressing the PSCAN button, causes the tuner to scan through preset stations, in either AM, FM or Satellite (if equipped) frequencies, pausing for 5 seconds at each preset station before continuing to the next. To stop the search, press PSCAN a second time.

Time Button

Press the time button and the time of day will be displayed for 5 seconds.

Clock Setting Procedure

1. Press and hold the time button until the hours blink.

2. Adjust the hours by turning the right side Tune/Audio control.

3. After the hours are adjusted, press the right side Tune/Audio control to set the minutes. The minutes will begin to blink.

4. Adjust the minutes using the right side Tune/Audio control.

5. To exit, press any button/knob or wait 5 seconds.

RW/FF (Radio Mode)

Pressing the rewind/fast forward button causes the tuner to search for the next frequency in the direction of the arrows. This feature operates in either AM, FM or Satellite (if equipped) frequencies.

TUNE Control (Radio Mode)

Turn the right side rotary control clockwise to increase or counter-clockwise to decrease the frequency.

AM/FM Button (Radio Mode)

Press the button to select AM or FM Modes.

Setting the Tone, Balance, and Fade

Press the rotary TUNE control and BASS will be displayed. Turn the TUNE control to the right or left to increase or decrease the Bass tones.

Press the rotary TUNE control a second time and MID will be displayed. Turn the TUNE control to the right or left to increase or decrease the Mid Range tones.

Press the rotary TUNE control a third time and TREB will be displayed. Turn the TUNE control to the right or left to increase or decrease the Treble tones.

Press the rotary TUNE control a fourth time and BAL will be displayed. Turn the TUNE control to the right or left to adjust the sound level from the right or left side speakers.

Press the rotary TUNE control a fifth time and FADE will be displayed. Turn the TUNE control to the left or right to adjust the sound level between the front and rear speakers.

Press the tune control again or wait 5 seconds to exit setting tone, balance, and fade.

RND/SET Button (Radio Mode) To SET The Push-Button Memory

When you are receiving a station that you wish to commit to push-button memory, press the SET button. The symbol SET 1 will now show in the display window. Select the button (1-6) you wish to lock onto this station and press and release that button. If a button is not selected within 5 seconds after pressing the SET button, the station will continue to play but will not be stored into push-button memory.

You may add a second station to each push-button by repeating the above procedure with this exception: Press

the SET button twice and SET 2 will show in the display window. Each button can be set for SET 1 and SET 2 in both AM and FM. This allows a total of 12 AM, 12 FM and 12 Satellite (if equipped) stations to be stored into push-button memory. The stations stored in SET 2 memory can be selected by pressing the push-button twice.

Every time a preset button is used a corresponding button number will be displayed.

Preset Buttons 1 - 6 (Radio Mode)

These buttons tune the Radio to the stations that you commit to push-button memory {12 AM, 12 FM, and 12 Satellite (if equipped) stations}.

Operation Instructions - CD Mode

NOTE: The ignition switch must be in the ON or ACC position to operate the radio.

Inserting The Compact Disc (Single CD Player)

Gently insert one CD into the CD player with the CD label facing up. The CD will automatically be pulled into the CD Player and the CD icon will illuminate on the radio display.

If the volume control is ON, the unit will switch to CD mode and begin to play. The display will show the track number and play time in minutes and seconds. Play will begin at the start of track one.

NOTE:

- On some vehicles you may insert or eject a disc with the radio or ignition switch OFF.
- If you insert a disc with the ignition ON and the radio OFF, the CD will automatically be pulled into the CD Player.
- This radio does not play discs with MP3 tracks.

SEEK Button (CD Mode)

Press the right side of the SEEK button for the next track on the CD. Press the left side of the button to return to the beginning of the current track, or return to the beginning of the previous track if the CD is within the first 10 seconds of the current selection.

MUTE Button (CD Mode)

Press the MUTE button to cancel the sound from the speakers. "MUTE" will be displayed. Press the MUTE button a second time and the sound from the speakers will return. Rotating the volume control or turning OFF the ignition will also return the sound from the speakers.

SCAN Button (CD Mode)

Press this button to play the first 10 seconds of each track. To stop the scan function, press the button a second time.

EJECT Button (CD Mode)

Press this button and the disc will unload and move to the entrance for easy removal. The unit will switch to the last selected mode.

If you do not remove the disc within 15 seconds, it will be reloaded. The radio mode will continue to appear.

TIME Button (CD Mode)

Press this button to change the display from elapsed CD playing time to time of day. The time of day will be displayed for 5 seconds.

RW/FF (CD Mode)

Press and hold the FF (Fast Forward) and the CD player will begin to fast forward until FF is released. The RW (Reverse) button works in a similar manner.

RND/SET Button (Random Play Button) (CD Mode)

Press this button while the CD is playing to activate Random Play. This feature plays the selections on the compact disc in random order to provide an interesting change of pace.

Press the SEEK button to move to the next randomly selected track.

Press and hold the FF button to fast forward through the tracks. Release the FF button to stop the fast forward feature. If the RW button is pressed, the current track will reverse to the beginning of the track and begin playing.

Press the RND button a second time to stop Random Play.

Operation Instructions - Auxiliary Mode

The auxiliary (AUX) jack is an audio input jack, which allows the user to plug in a portable device such as an MP3 player, cassette player or microphone and utilize the vehicle's audio system to amplify the source and play through the vehicle speakers.

The auxiliary mode becomes active when an electrical device is plugged into the AUX jack using a standard 3.5 mm stereo audio cable and the user presses and releases the MODE button until AUX appears on the display.

NOTE: The radio will return to the last stored mode if the ignition switch is turned from the OFF/LOCK position to the ACC position, the radio is turned on, and the radio was previously in the AUX mode.

SEEK Button (Auxiliary Mode)

No function.

MUTE Button (Auxiliary Mode)

Press the MUTE button to cancel the sound from the speakers. "MUTE" will be displayed. Press the MUTE button a second time and the sound from the speakers will return. Rotating the volume control or turning OFF the ignition will also return the sound from the speakers.

SCAN Button (Auxiliary Mode)

No function.

EJECT Button (Auxiliary Mode)

No function.

**PSCAN Button (Auxiliary Mode)**

No function.

TIME Button (Auxiliary Mode)

Press this button to change the display from elapsed playing time to time of day. The time of day will be displayed for 5 seconds.

RW/FF (Auxiliary Mode)

No function.

RND/SET Button (Auxiliary Mode)

No function.

Mode Button (Auxiliary Mode)

Press the mode button repeatedly to select between the CD player or Satellite Radio (if equipped).

Operating Instructions - Hands Free Phone — If Equipped

Refer to the HANDS FREE PHONE (UConnect™) section of the Owner's Manual.

Operating Instructions - Satellite Radio — If Equipped

Refer to the Satellite Radio section of the Owner’s Manual.

SALES CODE RAQ – AM/FM/CD (6-DISC) RADIO WITH OPTIONAL SATELLITE RADIO, HANDS FREE PHONE, AND VEHICLE ENTERTAINMENT SYSTEMS (VES) CAPABILITIES

NOTE: The radio sales code is located on the lower right side of your radio faceplate.

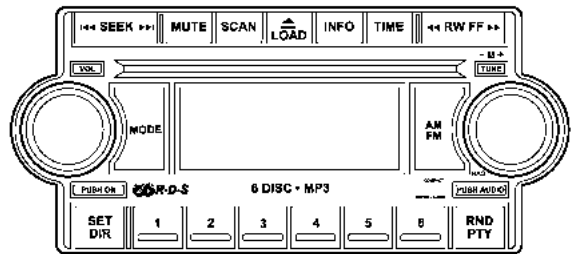

81365bb1

RAQ Radio

Operating Instructions - Radio Mode

NOTE: The ignition switch must be in the ON or ACC position to operate the radio.

Power Switch/Volume Control (Rotary)

Press the ON/VOL control to turn the radio ON. Press the ON/VOL a second time to turn OFF the radio.

Electronic Volume Control

The electronic volume control turns continuously (360 degrees) in either direction without stopping. Turning the volume control to the right increases the volume and to the left decreases it.

When the audio system is turned on, the sound will be set at the same volume level as last played.

For your convenience, the volume can be turned down, but not up, when the audio system is off and the ignition is ON.

Mode Button (Radio Mode)

Press the mode button repeatedly to select between the CD player, Satellite Radio, or Vehicle Entertainment System (VES) (if equipped).

SEEK Button (Radio Mode)

Press and release the SEEK button to search for the next listenable station in either AM/FM or Satellite (if equipped) mode. Press the right side of the button to seek up and the left side to seek down. The radio will remain tuned to the new station until you make another selection. Holding the button will bypass stations without stopping until you release it.

MUTE Button (Radio Mode)

Press the MUTE button to cancel the sound from the speakers. "MUTE" will be displayed. Press the MUTE button a second time and the sound from the speakers will return. Rotating the volume control, turning the radio ON/OFF, or turning OFF the ignition will also return the sound from the speakers

NOTE: In Hands Free Phone (if equipped) mode, the MUTE button mutes the microphone.

SCAN Button (Radio Mode)

Pressing the SCAN button causes the tuner to search for the next listenable station, in either AM, FM or Satellite (if equipped) frequencies, pausing for 5 seconds at each listenable station before continuing to the next. To stop the search, press SCAN a second time.

MSG or INFO Button (Radio Mode)

Press the MSG or INFO button for an RBDS station (one with call letters displayed). The radio will return a Radio Text message broadcast from an FM station (FM mode only).

Time Button

Press the time button and the time of day will be displayed for 5 seconds.

Clock Setting Procedure

1. Press and hold the time button until the hours blink.

2. Adjust the hours by turning the right side Tune / Audio control.

3. After the hours are adjusted, press the right side Tune / Audio control to set the minutes. The minutes will begin to blink.

4. Adjust the minutes using the right side Tune / Audio control.

5. To exit, press any button/knob or wait 5 seconds.

RW/FF (Radio Mode)

Pressing the rewind/fast forward button causes the tuner to search for the next frequency in the direction of the arrows. This feature operates in either AM, FM or Satellite (if equipped) frequencies.

TUNE Control (Radio Mode)

Turn the right side rotary control clockwise to increase or counter-clockwise to decrease the frequency.

AM/FM Button (Radio Mode)

Press the button to select AM or FM Modes.

Setting the Tone, Balance, and Fade

Press the rotary TUNE control and BASS will display. Turn the TUNE control to the right or left to increase or decrease the Bass tones.

Press the rotary TUNE control a second time and MID will display. Turn the TUNE control to the right or left to increase or decrease the Mid Range tones.

Press the rotary TUNE control a third time and TREBLE will display. Turn the TUNE control to the right or left to increase or decrease the Treble tones.

Press the rotary TUNE control a fourth time and BALANCE will display. Turn the TUNE control to the right or left to adjust the sound level from the right or left side speakers.

Press the rotary TUNE control a fifth time and FADE will display. Turn the TUNE control to the left or right to adjust the sound level between the front and rear speakers.

Press the rotary TUNE control again to exit setting tone, balance and fade.

RND/PTY Button (Radio Mode)

Pressing this button once will turn on the PTY mode for 5 seconds. If no action is taken during the 5 second time out the PTY icon will turn off. Pressing the PTY button or turning the TUNE rotary knob within 5 seconds will allow the program format type to be selected. Many radio stations do not currently broadcast PTY information.

252 UNDERSTANDING YOUR INSTRUMENT PANEL

Toggle the PTY button to select the following format types:

Program Type	16 Digit-Character Display
No program type or undefined	None
Adult Hits	Adult_Hits
Alert Alert	Alert Alert
Classical	Classical
Classic Rock	Classic_Rock
College	College
Country	Country
Emergency Test	Emergency Test
Foreign Language	Foreign_Language
Information	Information
Jazz	Jazz
News	News

Nostalgia	Nostalgia
Oldies	Oldies
Personality	Personality
Public	Public
Rhythm and Blues	Rhythm_and_Blues
Religious Music	Religious_Music
Religious Talk	Religious_Talk
Rock	Rock
Soft	Soft
Soft Rock	Soft_Rock
Soft Rhythm and Blues	Soft_R_&_B
Sports	Sports
Talk	Talk
Top 40	Top_40
Weather	Weather

By pressing the SEEK button when the PTY icon is displayed, the radio will be tuned to the next frequency

station with the same selected PTY name. The PTY function only operates when in the FM mode.

If a preset button is activated while in the PTY (Program Type) mode, the PTY mode will be exited and the radio will tune to the preset station.

SET/DIR Button (Radio Mode) — To Set the Push-Button Memory

When you are receiving a station that you wish to commit to push-button memory, press the SET/DIR button. The symbol SET 1 will now show in the display window. Select the button (1-6) you wish to lock onto this station and press and release that button. If a button is not selected within 5 seconds after pressing the SET/DIR button, the station will continue to play but will not be stored into push-button memory.

You may add a second station to each push-button by repeating the above procedure with this exception: Press the SET/DIR button twice and SET 2 will show in the display window. Each button can be set for SET 1 and SET 2 in both AM and FM. This allows a total of 12 AM, 12 FM and 12 Satellite (if equipped) stations to be stored into push-button memory. The stations stored in SET 2 memory can be selected by pressing the push-button twice.

Every time a preset button is used a corresponding button number will be displayed.

Buttons 1 - 6 (Radio Mode)

These buttons tune the Radio to the stations that you commit to push-button memory {12AM, 12 FM, and 12 Satellite (if equipped) stations}.

Operation Instructions - (CD MODE for CD Audio Play)

NOTE: The ignition switch must be in the ON or ACC position to operate the radio.

NOTE: Note: This Radio is capable of playing compact discs (CD), recordable compact discs (CD-R), rewritable compact discs (CD-RW) compact discs with MP3 tracks and multisession compact discs with CD and MP3 tracks.

Inserting Compact Disc(s)

Gently insert one CD into the CD player with the CD label facing up. The CD will automatically be pulled into the CD Player and the CD icon will illuminate on the radio display.

CAUTION!

This CD player will accept 4 3/4 inch (12 cm) discs only. The use of other sized discs may damage the CD player mechanism.

You may eject a disc with the radio OFF.

If you insert a disc with the ignition ON and the radio ON, the unit will switch from radio to CD mode and begin to play when you insert the disc. The display will show the disc number, the track number, and index time in minutes and seconds. Play will begin at the start of track 1.

SEEK Button (CD MODE for CD Audio Play)

Press the right side of the SEEK button for the next selection on the CD. Press the left side of the button to return to the beginning of the current selection, or return

to the beginning of the previous selection if the CD is within the first 10 seconds of the current selection.

MUTE Button (CD MODE for CD Audio Play)

Press the MUTE button to cancel the sound from the speakers. "MUTE" will be displayed. Press the MUTE button a second time and the sound from the speakers will return. Rotating the volume control, turning the radio ON/OFF, or turning OFF the ignition will also return the sound from the speakers.

SCAN Button (CD MODE for CD Audio Play)

Press the Scan button to scan through each track on the CD currently playing.

LOAD/EJECT Button (CD Mode for CD Audio Play)

LOAD/ EJECT - Load



Press the LOAD/ EJECT button and the push-button with the corresponding number where the CD is being loaded. The radio will display

PLEASE WAIT and prompt when to INSERT DISC. After the radio displays "LOAD DISC" insert the CD into the player.

Radio display will show "LOADING DISC" when the disc is loading, and "READING DISC" when the radio is reading the disc.

LOAD / EJT - Eject



Press the LOAD/ EJT button and the push-button with the corresponding number where the CD was loaded and the disc will unload and move to the entrance for easy removal.

Radio display will show "EJECTING DISC" when the disc is being ejected and prompt the user to remove the disc.

Press and hold the LOAD/ EJT button for 5 seconds and all CDs will be ejected from the radio.

If you have ejected a disc and have not removed it within 15 seconds, it will be reloaded. If the CD is not removed,

the radio will continue to play the non-removed CD. If the CD is removed and there are other CD's in the radio, the radio will play the next CD after a 2 minute timeout. If the CD is removed and there are no other CD's in the radio, the radio will remain in CD mode and display "INSERT DISC" for 10 seconds. If no discs are inserted within 10 seconds "NO DISCS LOADED" will be displayed.

On some vehicles a disc can be ejected with the radio and ignition OFF.

TIME Button (CD MODE for CD Audio Play)

Press this button to change the display from a large CD playing time display to a small CD playing time display.

RW/FF (CD MODE for CD Audio Play)

Press and hold FF (Fast Forward) and the CD player will begin to fast forward until FF is released or RW or another CD button is pressed. The RW (Reverse) button works in a similar manner.

TUNE Control (CD MODE for CD Audio Play)

Pressing the TUNE control allows the setting of the Tone, Fade, and Balance. See Radio Mode.

AM/FM Button (CD MODE for CD Audio Play)

Switches the Radio to the Radio mode.

RND/PTY Button (Random Play Button) (CD MODE for CD Audio Play)

Press this button while the CD is playing to activate Random Play. This feature plays the selections on the compact disc in random order to provide an interesting change of pace.

Press the SEEK button to move to the next randomly selected track.

Press and hold the FF button to fast forward through the tracks. Release the FF button to stop the fast forward feature.

Press the RND button a second time to stop Random Play.

Buttons 1 - 6 (CD MODE for CD Audio Play)

Selects disc positions 1 - 6 for Play/Load/Eject.

Notes On Playing MP3 Files

The radio can play MP3 files, however, acceptable MP3 file recording media and formats are limited. When writing MP3 files, pay attention to the following restrictions.

Supported Media (Disc Types)

The MP3 file recording media supported by the radio are CD-ROM, CD-R and CD-RW.

Supported Medium Formats (File Systems)

The medium formats supported by the radio are ISO 9660 Level 1 and Level 2 and includes the Joliet extension. When reading discs recorded using formats other than ISO 9660 Level 1 and Level 2, the radio may fail to read

files properly and may be unable to play the file normally. UDF and Apple HFS formats are not supported.

The radio uses the following limits for file systems:

- Maximum number of directory levels: 15
- Maximum number of files: 255
- Maximum number of folders: 100
- Maximum number of characters in file/folder names:
 - Level 1: 12 (including a separator "." and a 3-character extension)
 - Level 2: 31 (including a separator "." and a 3-character extension)

Multisession disc formats are supported by the radio. Multisession discs may contain combinations of normal CD audio tracks and computer files (including MP3 files). Discs created with an option such as "keep disc open after

writing” are most likely multisession discs. The use of multisession for CD audio or MP3 playback may result in longer disc loading times.

Supported MP3 File Formats

The radio will recognize only files with the *.mp3 extension as MP3 files. Non-MP3 files named with the *.mp3 extension may cause playback problems. The radio is designed to recognize the file as an invalid MP3 and will not play the file.

When using the MP3 encoder to compress audio data to an MP3 file, the bit rate and sampling frequencies in the following table are supported. In addition, variable bit rates (VBR) are also supported. The majority of MP3 files use a 44.1 kHz sampling rate and a 192, 160, 128, 96 or VBR bit rates.

MPEG Specification	Sampling Frequency (kHz)	Bit rate (kbps)
MPEG-1 Audio Layer 3	48, 44.1, 32	320, 256, 224, 192, 160, 128, 112, 96, 80, 64, 56, 48, 40, 32
MPEG-2 Audio Layer 3	24, 22.05, 16	160, 128, 144, 112, 96, 80, 64, 56, 48, 40, 32, 24, 16, 8

ID3 Tag information for artist, song title and album title are supported for version 1 ID3 tags. ID3 version 2 is not supported by the radios.

Playlist files are not supported. MP3 Pro files are not supported.

Playback of MP3 Files

When a medium containing MP3 data is loaded, the radio checks all files on the medium. If the medium contains a lot of folders or files, the radio will take more time to start playing the MP3 files.

Loading times for playback of MP3 files may be affected by the following:

- Media - CD-RW media may take longer to load than CD-R media
- Medium formats - Multisession discs may take longer to load than non-multisession discs
- Number of files and folders - Loading times will increase with more files and folders

To increase the speed of disc loading, it is recommended to use CD-R media and single-session discs. To create a single-session disc, enable the Disc at Once option before writing to the disc.

Operation Instructions - (CD Mode for MP3 Audio Play)

SEEK Button (CD Mode for MP3 Play)

Pressing the right side of the SEEK button plays the next MP3 File. Pressing the left side of the SEEK button plays the beginning of the MP3 file. Pressing the button within the first ten seconds plays the previous file.

LOAD/EJECT Button (CD Mode for MP3 Play)

LOAD/ EJECT - Load



Press the LOAD/ EJECT button and the push-button with the corresponding number where the CD is being loaded. The radio will display PLEASE WAIT and prompt when to INSERT DISC. After the radio displays "LOAD DISC" insert the CD into the player.

Radio display will show "LOADING DISC" when the disc is loading.

LOAD / EJECT - Eject

Press the LOAD/ EJECT button and the push-button with the corresponding number where the CD was loaded and the disc will unload and move to the entrance for easy removal.

Radio display will show "EJECTING DISC" when the disc is being ejected and prompt the user to remove the disc.

If you have ejected a disc and have not removed it within 15 seconds, it will be reloaded. If the CD is not removed, the radio will continue to play the non-removed CD. If the CD is removed and there are other CD's in the radio, the radio will play the next CD after a 2 minute timeout. If the CD is removed and there are no other CD's in the radio, the radio will remain in CD mode and display "INSERT DISC" for 2 minutes. After 2 minutes the radio will go to the previous tuner mode.

MSG or INFO Button (CD Mode for MP3 Play)

Press and MSG or INFO button while playing MP3 disc. The radio scrolls through the following TAG information: Song Title, Artist, File Name, and Folder Name (if available).

Press the MSG or INFO button once more to return to "elapsed time" priority mode.

Press and hold the MSG or INFO button while in the message display priority mode or elapsed time display priority mode will display the song title for each file.

RW/FF (CD Mode for MP3 Play)

Press the FF side of the button to move forward through the MP3 selection.

TUNE Control (CD Mode for MP3 Play)

Pressing the TUNE Control allows the adjustment of Tone, Balance, and Fade.

AM/FM Button (CD Mode for MP3 Play)

Switches back to Radio mode.

RND/ PTY Button (CD Mode for MP3 Play)

Pressing this button plays files randomly.

SET/DIR Button (CD Mode for MP3 Play)

Press the SET/DIR Button to display folders, when playing an MP3 discs that have a file/folder structure. Turn the TUNE control to display available folders or move through available folders. Press the TUNE control to select a folder.

Buttons 1 - 6 (CD Mode for MP3 Play)

Selects disc positions 1 - 6 for Play/Load/Eject.

Operating Instructions - Hands Free Phone (If Equipped)

Refer to Hands Free Phone in Section 3 of the Owner's Manual.

Operating Instructions - Satellite Radio Mode (If Equipped)

Refer to the Satellite Radio section of the Owner's Manual.

Operating Instructions - Video Entertainment System (VES®) (If Equipped)

Refer to separate Video Entertainment System (VES®) Guide.

4

SATELLITE RADIO — IF EQUIPPED

Satellite radio uses direct satellite to receiver broadcasting technology to provide clear digital sound, coast to coast. The subscription service provider is Sirius™ Satellite Radio. This service offers over 100 channels of music, sports, news, entertainment, and programming for children, directly from its satellites and broadcasting studios.

System Activation

To activate your Sirius Satellite Radio service, call the toll-free number 888-539-7474, or visit the Sirius web site at www.sirius.com. Please have the following information available when activating your system:

1. The Electronic Serial Number/Sirius Identification Number (ESN/SID).
2. Credit card information.
3. Your Vehicle Identification Number.

Electronic Serial Number/Sirius Identification Number (ESN/SID)

The Electronic Serial Number/Sirius Identification Number is needed to activate your Sirius Satellite Radio system. To access the ESN/SID, refer to the following steps:

ESN/SID Access With REF Radios

With the ignition switch in the ACCESSORY position and the radio OFF, press the CD Eject and Time buttons simultaneously for 3 seconds. The first four digits of the twelve-digit ESN/SID number will be displayed. Press the SEEK UP button to display the next four digits. Continue to press the SEEK UP button until all twelve ESN/SID digits have been displayed. The SEEK DOWN will page down until the first four digits are displayed. The radio will exit the ESN/SID mode when any other button is pushed, the ignition is turned OFF, or 5 minutes has passed since any button was pushed.

ESN/SID Access With RAQ Radios

With the ignition switch in the ACCESSORY position and the radio OFF, press the CD Eject and TIME buttons simultaneously for 3 seconds. All twelve ESN/SID numbers will be displayed. The radio will exit the ESN/SID

mode when any other button is pushed, the ignition is turned OFF, or 5 minutes has passed since any button was pushed.

ESN/SID Access With Navigation Radios

Please refer to your Navigation User's Manual.

Selecting Satellite Mode in REF, and RAQ, Radios

Selecting Satellite Mode — REF Radio

Press the MODE button repeatedly until the word "SAT" appears in the display.

A CD may remain in the radio while in the Satellite radio mode.

Selecting Satellite Mode — RAQ Radio

Press the MODE button repeatedly until the word "SAT" appears in the display.

These radios will also display the current station name and program type. For more information such as song title and artist press the MSG or INFO button.

A CD or tape may remain in the radio while in the Satellite radio mode.

Selecting a Channel

Press and release the SEEK or TUNE knob to search for the next channel. Press the top of the button to search up and the bottom of the button to search down. Holding the TUNE button causes the radio to bypass channels until the button is released.

Press and release the SCAN button (if equipped) to automatically change channels every 7 seconds. The radio will pause on each channel for 7 seconds before moving on to the next channel. The word "SCAN" will appear in the display between each channel change. Press the SCAN button a second time to stop the search.

NOTE: Channels that may contain objectionable content can be blocked. Contact Sirius Customer Care at 888-539-7474 to discuss options for channel blocking or unblocking. Please have your ESN/SID information available.

Storing and Selecting Pre-Set Channels

In addition to the 12 AM and 12 FM pre-set stations, you may also commit 12 satellite stations to push button memory. These satellite channel pre-set stations will not erase any AM or FM pre-set memory stations. Follow the memory pre-set procedures that apply to your radio.

Using the PTY (Program Type) Button (if equipped)

Follow the PTY button instructions that apply to your radio.

PTY Button "SCAN"

When the desired program type is obtained, press the "SCAN" button within five seconds. The radio will play 7 seconds of the selected channel before moving to the next channel of the selected program type. Press the "SCAN" button a second time to stop the search.

NOTE: Pressing the "SEEK" or "SCAN" button while performing a music type scan will change the channel by one and stop the search. Pressing a pre-set memory button during a music type scan, will call up the memory channel and stop the search.

PTY Button "SEEK"

When the desired program is obtained, press the "SEEK" button within five seconds. The channel will change to the next channel that matches the program type selected.

Satellite Antenna

To ensure optimum reception, do not place items on the roof around the rooftop antenna location. Metal objects placed within the line of sight of the antenna will cause decreased performance. Larger luggage items should be placed as far forward as possible. Do not place items directly on or above the antenna. The luggage rack (if equipped), should also not be positioned directly above the antenna.

Reception Quality

Satellite reception may be interrupted due to one of the following reasons.

- The vehicle is parked in an underground parking structure or under a physical obstacle.
- Dense tree coverage may interrupt reception in the form of short audio mutes.

- Driving under wide bridges or along tall buildings can cause intermittent reception.
- Placing objects over or too close to the antenna can cause signal blockage.

CD/DVD DISC MAINTENANCE

To keep the CD/DVD discs in good condition, take the following precautions:

4

1. Handle the disc by its edge; avoid touching the surface.
2. If the disc is stained, clean the surface with a soft cloth, wiping from center to edge.
3. Do not apply paper, paper CD labels, or tape to the disc; avoid scratching the disc.
4. Do not use solvents such as benzine, thinner, cleaners, or antistatic sprays.
5. Store the disc in its case after playing.

6. Do not expose the disc to direct sunlight.
7. Do not store the disc where temperatures may become too high.

RADIO OPERATION AND CELLULAR PHONES

Under certain conditions, the cellular phone being On in your vehicle can cause erratic or noisy performance from your radio. This condition may be lessened or eliminated by relocating the cellular phone antenna. This condition is not harmful to the radio. If your radio performance does not satisfactorily “clear” by the repositioning of the antenna, it is recommended that the radio volume be turned down or off during cellular phone operation.

CLIMATE CONTROLS

Climate Controls

The Climate Control System allows you to balance the temperature, amount, and direction of air circulating throughout the vehicle. The controls are located on the instrument panel, below the radio.

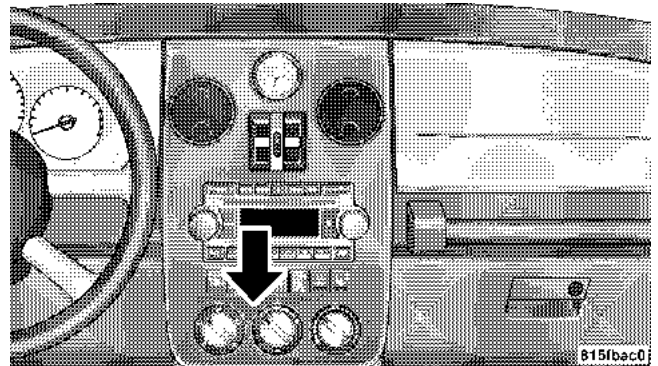

Climate Controls

The air conditioning system of your vehicle contains R-134a, a refrigerant that does not deplete the ozone layer in the upper atmosphere.

The controls are as follows:

Fan Control

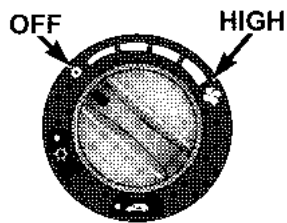

815fbac4

Use this control to regulate the amount of air forced through the system in any mode you select. The fan speed increases as you move the control to the right from the OFF position.

Mode Control (Air Direction)

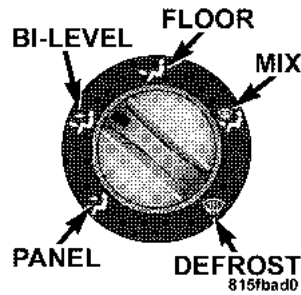

The mode control allows you to choose from several patterns of air distribution. You can select either a primary mode, as identified by the symbols, or a blend of two of these modes. The closer the control is to a particular mode, the more air distribution you receive from that

mode.

Panel

 Air is directed through the outlets in the instrument panel. These outlets can be adjusted to direct air flow.

Bi-Level

 Air is directed through the panel and floor outlets.

NOTE: There is a difference in temperature between the upper and lower outlets for added comfort. The warmer air goes to the floor outlets. This feature gives improved comfort during sunny but cool conditions.

Floor

 Air is directed through the floor outlets and side window demist outlets with a small amount through the defrost outlet.

Mix

 Air is directed through the floor, defrost and side window demist outlets. This setting works best in cold or snowy conditions that require extra heat at the windshield. This setting is good for maintaining comfort while reducing moisture on the windshield.

Defrost

 Air is directed through the windshield and side window demist outlets. Use this mode with maximum fan and temperature settings for best windshield and side window defrosting.

NOTE: The air conditioning compressor operates in both Mix and Defrost or a blend of these modes even if the fan switch is not in the A/C position. This dehumidifies the air to help dry the windshield. To improve fuel economy, use these modes only when necessary.

Air Outlets

The airflow from each of the instrument panel outlets can be adjusted for direction and turned on or off to control air flow.

NOTE: For maximum airflow to the rear seat passengers, the center instrument panel outlets can be aimed, so that the left center outlet is directed toward the right rear passenger and the right center outlet is directed toward the left rear passenger.

Temperature Control

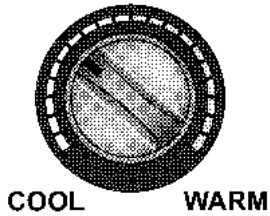

815f5a8d

Use this control to regulate the temperature of the air inside the passenger compartment. The blue area of the scale indicates cooler temperatures while the red area indicates warmer temperatures.

NOTE: If your air conditioning performance seems lower than expected, check the front of the A/C condenser: located in front of the radiator, for an accumulation of dirt or insects. Clean with a gentle water spray from behind the radiator and through the condenser. Fabric front fascia protectors may reduce air flow to the condenser, reducing air conditioning performance.

Air Conditioning

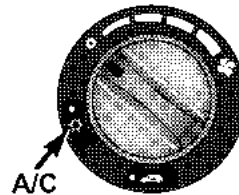

815fbac8

Use this button to engage the Air Conditioning. A lamp will illuminate when the Air Conditioning System is engaged

NOTE: The air conditioning compressor will not engage until the engine has been running for about 10 seconds.

Circulation Control

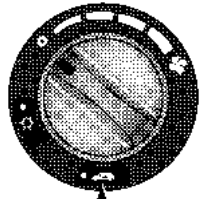

RECIRCULATE

815fbacc

start up in very hot or humid weather.



















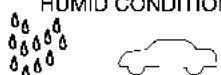

Use this button to choose between outside air intake or recirculation of the air inside the vehicle. A lamp will illuminate when you are in recirculate mode. Only use the recirculate mode to temporarily block out any outside odors, smoke, or dust and to cool the interior rapidly upon initial

NOTE: Continuous use of the recirculate mode may make the inside air stuffy and window fogging may occur. Extended use of this mode is not recommended.

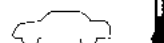
In cold or damp weather, the use of the Recirculate position will cause windows to fog on the inside because of moisture build up inside the vehicle. For maximum defogging, select the Outside Air position.

NOTE: Recirculation Mode will not operate in floor, mix or defrost modes.

Operating Tips

WEATHER	CONTROL SETTINGS
<p>HOT WEATHER AND VEHICLE INTERIOR IS VERY HOT</p> 	<p>Open the windows, start the vehicle, and place the Circulation control at . Set the Fan control to the high A/C position (full counterclockwise) position. Set the Mode control at or between  and . Set the temperature control to full cool. After the hot air is flushed from the vehicle, turn the Circulation control to  and roll up the windows. Once you are comfortable, place the Circulation control at  and adjust the temperature control for comfort.</p>
<p>WARM WEATHER</p> 	<p>Set the Circulation control to . If it's sunny, set the Mode control at or near  and turn the air conditioning on. If it's cloudy or dark, set the Mode control at or near .</p>
<p>COOL OR COLD HUMID CONDITIONS</p> 	<p>Set the Circulation control to . If it's sunny, set the Mode control at or between  and  then turn the air conditioning on. If it's cloudy or dark, set the Mode control at or near  and turn the air conditioning on.</p>
<p>COLD DRY CONDITIONS</p> 	<p>Set the Circulation control to . Set the Mode control at or near . If it is sunny, you may want more upper air. In this case, set the Mode control at or between  and . In very cold weather, if you need extra heat at the windshield, set the Mode control at or near the .</p>

Window Fogging

Vehicle side windows tend to fog on the inside in mild rainy or humid weather. To clear the windows, use the A/C, PANEL and blower controls. Direct the panel outlets toward the side windows. Do not use recirculate without A/C for long periods as fogging may occur.

Interior fogging on the windshield can be quickly removed by using the defrost position.

If the fogging problem persists, clean the inside window surfaces. The cause of undue fogging may be dirt collecting on the inside surface of the glass

NOTE: In cold weather, the use of the recirculate position will cause windows to fog on the inside because of moisture build up inside the vehicle. For maximum defogging, use the Outside Air position.

Summer Operation

Air conditioned vehicles must be protected with a high-quality antifreeze coolant to provide proper corrosion protection and to raise the boiling point of the coolant for protection against overheating. A 50% concentration is recommended.

Outside Air Intake

When operating the system during the winter months, make sure the air intake, directly in front of the windshield, is free of ice, slush, snow or other obstructions such as leaves. Leaves collected in the air-intake plenum may reduce air flow and plug the plenum water drains.

The blower air will heat faster in cold weather if you use only a low blower speed for the first few minutes of vehicle operation.

Side Window Demisters

A side window demister outlet is at each end of the instrument panel. These nonadjustable outlets direct air

toward the side windows when the system is in either the FLOOR, MIX, or DEFROST mode. The air is directed at the area of the windows through which you view the outside mirrors.

REAR WINDOW FEATURES

Electric Rear Window Defroster

 The push-button is located at the center of the instrument panel, below the radio. Press this button to turn on the rear window defroster, and the optional electric remote control heated mirrors. An amber light shows that the defroster is on.

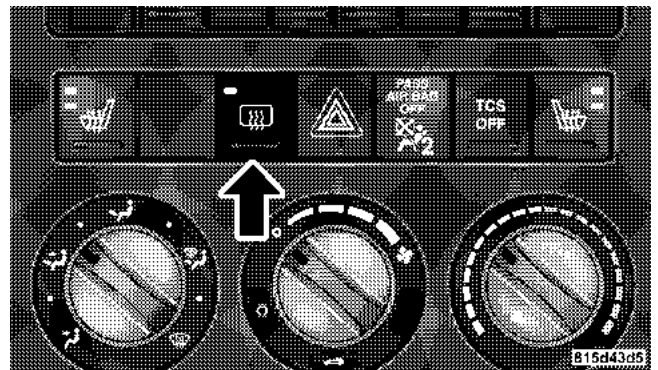

Rear Defroster Switch

NOTE: The defroster turns off automatically after 10 minutes of operation. Each following activation of the defroster will last for five minutes.

CAUTION!

To avoid damaging the electrical conductors, do not use scrapers, sharp instruments, or abrasive window cleaners on the interior surface of the rear window. Labels can be peeled off after soaking with warm water.

Rear Wiper/Washer Switch — If Equipped

A switch on the right side of the steering column controls operation of the rear wiper/washer function. Rotating the center of the switch forward to the ON position will activate the wiper. Rotating the center of the switch all the way forward will turn on the wash function. The wash pump will continue to operate as long as the button is pressed. Upon release, the wipers will cycle two times before returning to the set position.

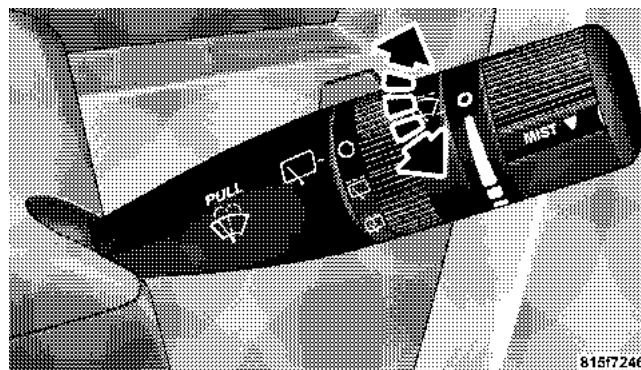
**Rear Wiper Switch**

If the rear wiper is operating when the ignition is turned OFF, the wiper will automatically return to the “Park” position if power accessory delay is active. Power accessory delay can be cancelled by opening the door, if this happens the rear wiper will stop at its current position and will not go to park.

Adding Washer Fluid

The fluid reservoir for the windshield washers and the rear window washer (If Equipped) is shared. It is located in the rear of the engine compartment on the passenger side and should be checked for fluid level at regular intervals. Fill the reservoir with windshield washer solvent (not radiator antifreeze) and operate the system for a few seconds to flush out the residual water.

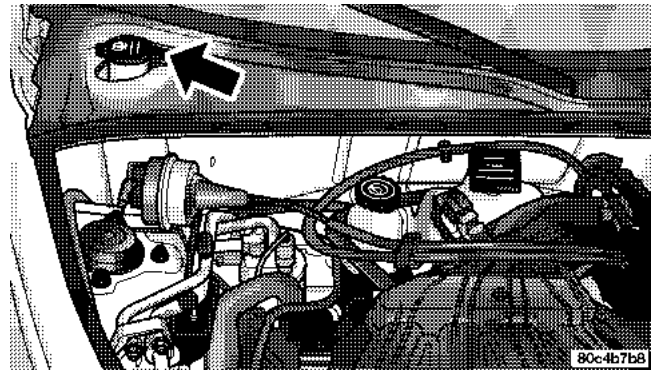

Washer Bottle

STARTING AND OPERATING

CONTENTS

■ Starting Procedures	280	■ Automatic Transaxle — If Equipped	284
□ Automatic Transaxle	280	□ Brake/Transmission Interlock System	285
□ Manual Transaxle	280	□ Automatic Transaxle Ignition Interlock System	285
□ Normal Starting	280	□ Four Speed Automatic Transaxle	285
□ Extremely Cold Weather (Below -20°F Or -29°C)	281	□ Reset Mode	285
□ If Engine Fails To Start	281	□ Gear Ranges For Four Speed Automatic Transaxle	286
□ After Starting	282	■ AutoStick — If Equipped	289
□ Turbocharger “Cool Down”	282	□ AutoStick Operation	289

278 STARTING AND OPERATING

□ AutoStick General Information	289	□ Tire Loading And Tire Pressure	307
■ Manual Transaxle Operation	290	■ Tires—General Information	311
□ 2.4 Liter Turbo— If Equipped	292	□ Tire Pressure	311
□ Recommended Shift Speeds	292	□ Tire Inflation Pressures	312
□ Downshifting	293	□ Radial-Ply Tires	314
■ Parking Brake	294	□ Compact Spare Tire — If Equipped	315
■ Brake System	296	□ Limited Use Spare — If Equipped	316
□ Anti-Lock Brake System (ABS) — If Equipped .	297	□ Tire Spinning	316
■ Power Steering	299	□ Tread Wear Indicators	317
■ Traction Control — If Equipped	300	□ Life Of Tire	318
■ Tire Safety Information	302	□ Replacement Tires	318
□ Tire Markings	302	□ Alignment And Balance	319
□ Tire Identification Number (TIN)	306	■ Tire Chains	320

■ Snow Tires	320	□ Loose Fuel Filler Cap Message	328
■ Tire Rotation Recommendations	321	■ Vehicle Loading	329
■ Fuel Requirements	322	■ Trailer Towing	329
□ 2.4L Standard Engine And 2.4L Standard Turbo Engine	322	□ Common Towing Definitions	330
□ 2.4L High Output Turbo Engine	322	□ Trailer Hitch Classification	332
□ Reformulated Gasoline	323	□ Trailer Towing Weights (Maximum Trailer Weight Ratings)	332
□ Gasoline/Oxygenate Blends	323	□ Trailer And Tongue Weight	333
□ MMT In Gasoline	324	□ Towing Requirements	334
□ Materials Added To Fuel	324	□ Towing Tips	339
□ Fuel System Cautions	324	■ Recreational Towing (Behind Motorhome, Etc.)	340
□ Carbon Monoxide Warnings	325	□ Towing This Vehicle Behind Another Vehicle (Flat Towing With All Four Wheels On The Ground)	340
■ Adding Fuel	326		
□ Fuel Filler Cap (Gas Cap)	326		

STARTING PROCEDURES

Before starting your vehicle, adjust your seat, adjust both inside and outside mirrors, and fasten your seat belts.

CAUTION!

Long periods of engine idling, especially at high engine speeds can cause excessive exhaust temperatures which can damage your vehicle. Do not leave your vehicle unattended with the engine running.

WARNING!

Do not leave children or animals inside parked vehicles in hot weather. Interior heat build up may cause serious injury or death.

Automatic Transaxle

The gear selector must be in the NEUTRAL or PARK position before you can start the engine. Apply the brakes before shifting to any driving gear.

NOTE: You must press the brake pedal before shifting out of Park.

Manual Transaxle

Before starting the engine fully apply the parking brake, press the clutch pedal to the floor and place the gear selector in NEUTRAL.

NOTE: The engine will not start unless the clutch pedal is pressed to the floor.

Normal Starting

Normal Starting of either a cold or a warm engine does not require pumping or depressing the accelerator pedal. Simply turn the ignition switch to the "START" position and release when the engine starts. If the engine has not

started within 3 seconds, slightly depress the accelerator pedal while continuing to crank. If the engine fails to start within 15 seconds, turn the ignition switch to the "OFF" position, wait 10 to 15 seconds, then repeat the normal starting procedure.

WARNING!

Do not attempt to push or tow your vehicle to get it started. Vehicles equipped with an automatic trans-axle cannot be started this way. Unburned fuel could enter the catalytic converter and once the engine has started, ignite and damage the converter and vehicle. If the vehicle has a discharged battery, booster cables may be used to obtain a start from another vehicle. This type of start can be dangerous if done improperly, so follow the procedure carefully. See section 6 of this manual for jump starting instructions.

Extremely Cold Weather (below -20°F or -29°C)

To insure reliable starting at these temperatures, use of an externally powered electric engine block heater (available from your dealer) is recommended.

If Engine Fails to Start

If the engine fails to start after you have followed the "NORMAL STARTING" procedure, it may be flooded. Push the accelerator pedal all the way to the floor and hold it there. Crank the engine for no more than 15 seconds. This should clear any excess fuel in case the engine is flooded. Leave the ignition key in the ON position, release the accelerator pedal and repeat the "NORMAL STARTING" procedure.

WARNING!

Never pour fuel or other flammable liquid into the throttle body air inlet opening in an attempt to start the vehicle. This could result in flash fire causing serious personal injury.

CAUTION!

To prevent damage to the starter, do not crank the engine for more than 15 seconds at a time. Wait 10 to 15 seconds before trying again.

After Starting

The idle speed will automatically decrease as the engine warms up.

Turbocharger “Cool Down”

NOTE: Letting the engine idle after severe operation allows the turbine housing to cool to normal operating temperature.

The following chart should be used as a guide in determining the amount of engine idle time required to sufficiently cool down the turbocharger before shut down, depending upon the type of driving and the amount of cargo.

TURBOCHARGER "COOL DOWN" CHART	
Driving Conditions	Idle Time (in minutes) Before Shut Down
Normal Driving	Not required.
Aggressive Driving or Heavily Loaded	3
Trailer Tow	5

AUTOMATIC TRANSAXLE — IF EQUIPPED**CAUTION!**

Damage to the transaxle may occur if the following precautions are not observed:

- Shift into PARK only after the vehicle has come to a complete stop.
- Shift into or out of REVERSE only after the vehicle has come to a complete stop and the engine is at idle speed.
- Do not shift from REVERSE, PARK, or NEUTRAL into any forward gear when the engine is above idle speed.
- Before shifting into any gear, make sure your foot is firmly on the brake pedal.

NOTE: You **MUST** press and hold the brake pedal down while shifting out of Park.

WARNING!

It is dangerous to shift the selector lever out of "P" or "N" if the engine speed is higher than idle speed. If your foot is not firmly on the brake pedal, the vehicle could accelerate quickly forward or in reverse. You could lose control of the vehicle and hit someone or something. Only shift into gear when the engine is idling normally and when your right foot is firmly on the brake pedal.

Brake/Transmission Interlock System

This system prevents you from moving the gear shift out of Park and into any gear unless the brake pedal is pressed. This system is active only while the ignition switch is in the ON or ACC positions. Always depress the **brake pedal first**, before moving the gear selector out of PARK.

NOTE: If a malfunction occurs, the system will function normally, except you may be able to shift the vehicle from PARK, without depressing the brake pedal. If this occurs obtain service as soon as possible.

Automatic Transaxle Ignition Interlock System

This system prevents the key from being removed unless the shift lever is in PARK and the shift knob push button is out. It also prevents shifting out of PARK unless the key is in the ACC or ON positions, and the brake pedal is depressed.

NOTE: If a malfunction occurs, the system will trap the key in the ignition cylinder to warn you that this safety feature is inoperable. The engine can be started and stopped but the key cannot be removed until you obtain service.

Four Speed Automatic Transaxle

The electronically controlled transaxle provides a precise shift schedule. The transaxle electronics are self calibrating; therefore, the first few shifts on a new vehicle may be somewhat abrupt. This is a normal condition, and precision shifts will develop within a few shift cycles.

Reset Mode

The transaxle is monitored electronically for abnormal conditions. If a condition is detected that could cause damage, the transaxle shifts automatically into second gear. The transaxle remains in second gear despite the forward gear selected. Park (P), Reverse (R), and Neutral

(N) will continue to operate. This second gear limp-in feature allows the vehicle to be driven to a dealer for service without damaging the transaxle.

In the event that the problem has been momentary, the transaxle can be reset to regain all forward gears.

Stop the vehicle and shift into Park (P).

Turn the Key to OFF then restart the engine.

Shift into D and resume driving.

NOTE: Even if the transaxle can be reset, it is recommended that you visit a dealer at your earliest possible convenience. Your dealer has diagnostic equipment to determine if the problem could recur.

If the transaxle cannot be reset, dealer service is required.

Gear Ranges For Four Speed Automatic Transaxle

DO NOT race the engine when shifting from PARK or NEUTRAL positions into another gear range.

“P” Park

Supplements the parking brake by locking the transmission. The engine can be started in this range. Never use P (Park) while the vehicle is in motion. Apply the parking brake when leaving the vehicle in this range. Always apply the parking brake first, and then place the selector in P (Park) position.

WARNING!

Unintended movement of a vehicle could injure those in and near the vehicle. As with all vehicles, you should never exit a vehicle while the engine is running. Before exiting a vehicle, you should always shift the vehicle into P (Park), remove the key from the ignition, and apply the parking brake. Once the key is removed from the ignition, the transmission shift lever is locked in the P (Park) position, securing the vehicle against unwanted movement. Furthermore, you should never leave children unattended inside a vehicle.

The following indicators should be used to ensure that you have engaged the transmission shift lever into the P (Park) position:

- When shifting into P (Park), depress the button on the shift lever and firmly move the lever all the way forward until it stops.
- Look at the shift indicator window on the console to ensure it is in the P (Park) position.
- When engaged in P (Park), you will not be able to move the shifter rearward without depressing the shift lever button.

CAUTION!

Before moving the shift lever out of P (Park), you must turn the ignition from LOCK to ON so the steering wheel and shift lever are released. Otherwise, damage to the steering column or shifter could result.

“R” Reverse

Shift into this range only after the vehicle has come to a complete stop.

“N” Neutral

Engine may be started in this range.

“D” Overdrive

This range should be used for most city and highway driving. It provides smoothest up shifts and down shifts and best fuel economy.

When frequent transaxle shifting occurs while using the Overdrive range, such as when operating the vehicle under heavy loading conditions (in hilly terrain, traveling into strong head winds, or while towing trailers), use the “3” range.

“3” Drive

This range eliminates shifts into Overdrive. The transaxle will operate normally in first and second while in this range.

NOTE: Using the “3” range while operating the vehicle under heavy operating conditions will improve performance, fuel economy, and extend transaxle life by reducing excessive shifting and heat build up.

Use the “3” range when descending steep grades to prevent brake system distress.

“1” Low

This range should be used for maximum engine braking when descending steep grades. In this range, up shifts will occur only to prevent engine over speed while down shifts from 2nd to first will occur as early as possible.

AUTOSTICK — IF EQUIPPED

Autostick is a driver-interactive transmission that offers manual gear shifting capability to provide you with more control. Autostick allows you to maximize engine braking, eliminate undesirable upshifts and downshifts, and improve overall vehicle performance. This system can also provide you with more control during passing, city driving, cold slippery conditions, mountain driving, trailer towing, and many other situations.

Autostick Operation

The Autostick position is just below the Overdrive position and is identified by the word "AUTOSTICK". When you place the shift lever in the Autostick position, it can be moved from side to side. Moving the lever to the left (-) triggers a downshift and to the right (+) an upshift. The gear position will be shown in the transmission gear display, located in the instrument cluster.

You can shift in or out of the autostick mode at any time without taking your foot off the accelerator pedal. If you choose the Overdrive mode, the transmission will operate automatically; shifting between the four available gears. When you wish to engage autostick, simply move the shift lever to the AUTOSTICK position. The transmission will remain in the current gear until an upshift or downshift is chosen.

Move the lever back to the Overdrive position to shift out of the Autostick mode.

Autostick General Information

- The transmission will automatically upshift from first to second gear and from second to third gear when engine speed reaches about 6300 RPM.
- Downshifts from third to second gear above 74 mph (119 km/h) and from second to first gear above 41 mph (66 km/h) will be ignored.

- You can start out in first, second, or third gear. Shifting into fourth gear can occur only after vehicle speed reaches 15 mph (24 km/h).
- The transmission will automatically downshift to first gear when coming to a stop.
- Starting out in third gear is helpful in snowy or icy conditions.
- While in the Autostick mode, Speed Control will only function in third or fourth gear.
Downshifting out of third gear will turn off the speed control.
- If the system detects powertrain overheating, the transmission will revert to the automatic shift mode and remain in that mode until the powertrain cools off.

- If the system detects a problem it will disable the Autostick mode and the transmission will return to the automatic mode until the problem is corrected.

MANUAL TRANSAXLE OPERATION

NOTE: The parking brake should be engaged and the gear selector placed in REVERSE before leaving the vehicle, especially on an incline.

Fully depress the clutch pedal before you shift gears. As you release the clutch pedal, lightly depress the accelerator pedal.

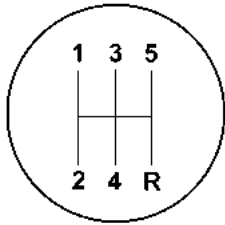

807bc4b

Use each gear in numerical order - do not skip a gear. Be sure the transaxle is in FIRST gear, (not THIRD), when starting from a standing position. Damage to the clutch can result from starting in THIRD.

For most city driving you will find it easier to use only the lower gears. For steady highway driving with light accelerations, 5th gear is recommended.

Never drive with your foot resting on the clutch pedal, or try to hold the vehicle on a hill with the clutch pedal partially engaged. This will cause abnormal wear on the clutch.

Never shift into REVERSE until the vehicle has come to a complete stop.

NOTE: During cold weather, until the transaxle lubricant is warm, you may experience slightly higher shift efforts. This is normal and not harmful to the transaxle.

2.4 Liter Turbo— If Equipped

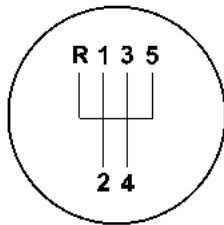

80f7bc54

The neutral position of the shift lever is located between THIRD and FOURTH gear. This is the position the shifter lever will return to automatically when neutral is selected. When shifting into FIFTH gear, be sure to press

the shifter lever all the way to the right to avoid accidentally selecting THIRD gear. Also, use care when selecting FIRST gear to avoid accidentally selecting REVERSE.

When moving the shifter lever into REVERSE press the lever to the left until the resistance is overcome. When the ignition switch is in the ON position, a chime will sound to confirm that reverse has been selected and the backup lights will illuminate.

NOTE: Listen for the audible chime to confirm REVERSE gear is properly selected. Never shift into REVERSE until the vehicle has come to a complete stop.

Recommended Shift Speeds

To use your manual transaxle for optimal fuel economy, it should be upshifted as listed in table 1.

TABLE 1-MANUAL TRANSAXLE NORMAL ACCELERATION AND CRUISE SHIFT SPEEDS IN mph (km/h)					
EN-GINE SIZE	MODE	1 to 2	2 to 3	3 to 4	4 to 5
2.4L Turbo	Accel	15 (24)	25 (40)	40 (65)	45 (72)
	Cruise	15 (24)	25 (40)	42 (68)	45 (72)
2.4L Non-Turbo	Accel	15 (24)	25 (40)	33 (53)	44 (70)
	Cruise	16 (26)	20 (32)	28 (45)	38 (61)

For improved performance, your manual transaxle may be upshifted up to the maximum speeds listed in table 2 (within legal speed limits).

TABLE 2-MANUAL TRANSAXLE MAXIMUM PERFORMANCE SHIFT SPEEDS IN mph (km/h)				
ENGINE SIZE	1 to 2	2 to 3	3 to 4	4 to 5
2.4L	30 (48)	60 (97)	85 (136)	115 (185)

If you exceed these speeds, you may notice the engine cut in and out. This is caused by an electronic limiter in the engine computer. The engine will run normally when you reduce engine speed.

Downshifting

Proper downshifting will improve fuel economy and prolong engine life.

CAUTION!

If you skip more than one gear while downshifting or downshift at too high an engine speed, you could damage the engine, transmission, or clutch.

To maintain a safe speed and prolong brake life, shift down to 2nd or 1st when descending a steep grade.

When turning a corner, or driving up a steep grade, downshift early so that the engine will not be overburdened.

PARKING BRAKE

BRAKE When the parking brake is applied with the ignition on, the Brake Light in the instrument cluster will come on.

NOTE: This light only shows that the parking brake is on. It does not show the degree of brake application.

If the parking brake is applied while the vehicle is moving, a chime will sound to alert the driver. The chime will sound up to 10 times or until the vehicle has returned to a stop.

Before leaving the vehicle, make sure that the parking brake is set. To set the parking brake, pull up firmly on the lever. Also place the gear selector in the Park position (automatic transaxle) or Reverse (manual transaxle). To release the parking brake, apply the brake pedal, pull up slightly on the lever, then depress the button on the end of the lever and push the lever fully down toward the floor.

NOTE: The parking brake lever will not release unless the lever is pulled up slightly past its applied position.

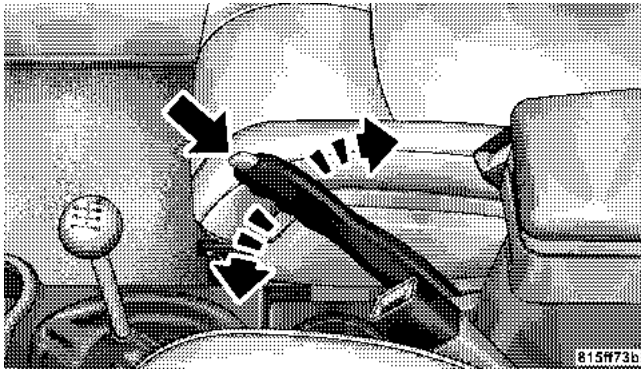

Parking Brake Lever

When parking on a hill, it is important to set the parking brake before placing the gear selector in Park, otherwise the load on the automatic transaxle locking mechanism may make it difficult to move the selector out of Park. As

an added precaution, turn the front wheels toward the curb on a downhill grade and away from the curb on an uphill grade.

You should always apply the parking brake before leaving the vehicle.

WARNING!

- Leaving children in a vehicle unattended is dangerous for a number of reasons. A child or others could be injured. Children should be warned not to touch the parking brake or the gear selector. Don't leave the keys in the ignition. A child could operate power windows, other controls, or move the vehicle.
- Be sure the parking brake is fully disengaged before driving; failure to do so can lead to brake failure and an accident.

BRAKE SYSTEM

Your vehicle is equipped with power assisted brakes as standard equipment. In the event power assist is lost for any reason (for example, repeated brake applications with the engine off), the brakes will still function. However, the effort required to brake the vehicle will be much greater than that required with the power system operating.

If either of the two hydraulic systems lose normal capability, the remaining system will still function with some loss of overall braking effectiveness. This will be evident by increased pedal travel during application and greater pedal force required to slow or stop. In addition, if the malfunction is caused by an internal leak, as the brake fluid in the master cylinder drops, the brake warning indicator will light.

WARNING!

Riding the brakes can lead to brake failure and possibly an accident. Driving with your foot resting or riding on the brake pedal can result in abnormally high brake temperatures, excessive lining wear, and possible brake damage. You wouldn't have your full braking capacity in an emergency.

WARNING!

Driving a vehicle with the brake light on is dangerous. A significant decrease in braking performance or vehicle stability during braking may occur. It will take you longer to stop the vehicle or will make your vehicle harder to control. You could have an accident. Have the vehicle checked immediately.

Anti-Lock Brake System (ABS) — If Equipped

The Anti-Lock Brake System provides increased vehicle stability and brake performance under most braking conditions. The system automatically “pumps” the brakes during severe braking conditions to prevent wheel lock-up.

WARNING!

Pumping of the Anti-Lock Brakes will diminish their effectiveness and may lead to an accident. Pumping makes the stopping distance longer. Just press firmly on your brake pedal when you need to slow down or stop.

WARNING!

- Anti-lock system (ABS) cannot prevent the natural laws of physics from acting on the vehicle, nor can it increase braking or steering efficiency beyond that afforded by the condition of the vehicle brakes and tires or the traction afforded.
- The ABS cannot prevent accidents, including those resulting from excessive speed in turns, following another vehicle too closely, or hydroplaning. Only a safe, attentive, and skillful driver can prevent accidents.
- The capabilities of an ABS equipped vehicle must never be exploited in a reckless or dangerous manner which could jeopardize the user’s safety or the safety of others.



The ABS light monitors the Anti-Lock Brake System. The light will come on when the ignition switch is turned to the ON position and may stay on for as long as four seconds.

If the ABS light remains on or comes on while driving, it indicates that the Anti-Lock portion of the brake system is not functioning and that service is required. However, the conventional brake system will continue to operate normally if the BRAKE warning light is not on.

If the ABS light is on, the brake system should be serviced as soon as possible to restore the benefits of Anti-Lock brakes. If the ABS light does not come on when the Ignition switch is turned to the ON position, have the bulb repaired as soon as possible.

If both the Brake Warning Light and the ABS Light remain on, the Anti-Lock brakes (ABS) and Electronic Brake Force Distribution (EBD) systems are not functioning. Immediate repair to the ABS system is required.

When the vehicle is driven over 7 mph (11 km/h), you may also hear a slight clicking sound as well as some related motor noises. These noises are the system performing its self check cycle to ensure that the ABS system is working properly. This self check occurs each time the vehicle is started and accelerated past 7 mph (11 km/h).

ABS is activated during braking under certain road or stopping conditions. ABS-inducing conditions can include ice, snow, gravel, bumps, railroad tracks, loose debris, or panic stops.

You also may experience the following when the brake system goes into Anti-lock:

- The ABS motor running (it may continue to run for a short time after the stop),
- the clicking sound of solenoid valves,
- brake pedal pulsations,

- and a slight drop or fall away of the brake pedal at the end of the stop.

These are all normal characteristics of ABS.

WARNING!

The Anti-Lock Brake System contains sophisticated electronic equipment that may be susceptible to interference caused by improperly installed or high output radio transmitting equipment. This interference can cause possible loss of anti-lock braking capability. Installation of such equipment should be performed by qualified professionals.

All vehicle wheels and tires must be the same size and type and tires must be properly inflated to produce accurate signals for the computer.

POWER STEERING

The standard power steering system will give you good vehicle response and increased ease of maneuverability in tight spaces. The system will provide mechanical steering capability if power assist is lost.

If for some reason, the power assist is interrupted, it will still be possible to steer your vehicle. Under these conditions you will observe a substantial increase in steering effort, especially at very low vehicle speeds and during parking maneuvers.

NOTE: Increased noise levels at the end of the steering wheel travel are considered normal and does not indicate that there is a problem with the power steering system.

Upon initial start-up in cold weather, the power steering pump may make noise for a short period of time. This is due to the cold, thick fluid in the steering system. This noise should be considered normal, and does not in any way damage the steering system.

WARNING!

Continued operation with reduced power steering assist could pose a safety risk to yourself and others. Service should be obtained as soon as possible.

CAUTION!

Prolong operation of the steering system at the end of the steering wheel travel will increase the steering fluid temperature and should be avoided when possible. Damage to the power steering pump may occur.

TRACTION CONTROL — IF EQUIPPED

The Traction Control System will improve acceleration and steering on slippery surfaces by reducing tire spin. The system reduces wheel slip and maintains traction at the driving (front) wheels by engaging the brake on the wheel that is losing traction. When this occurs the TRAC indicator light located above the instrument cluster odometer will flash. The system operates at speeds below 35 mph (56 km/h).

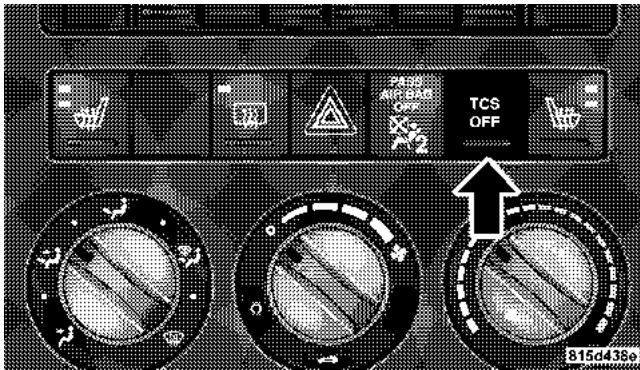

Traction Control Switch

A push-button at the center of the instrument panel, below the radio, turns the Traction Control System ON or OFF.

The system is always in the “ON” mode unless:

- The TRAC OFF switch has been used to turn the system off;
- There is a Anti-Lock Brake System malfunction;
- There is a Traction Control System malfunction;
- The system has been automatically deactivated to prevent damage to the brake system due to overheated brake temperatures.

5

NOTE: Extended heavy use of Traction Control may cause the system to deactivate and turn on the TRAC OFF Light located in the instrument cluster.

This is to prevent overheating of the brake system and is a normal condition. The system will remain disabled for about 4 minutes until the brakes have cooled. The system will automatically reactivate and turn off the TRAC OFF light.

If your vehicle becomes stuck in mud, ice, or snow, turn the Traction Control System Off before attempting to “rock” the vehicle free.

TIRE SAFETY INFORMATION

Tire Markings

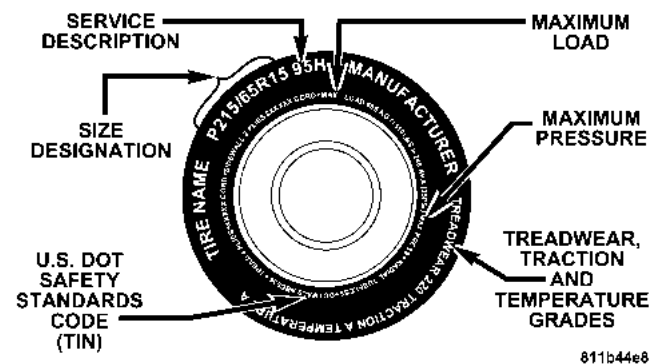

NOTE:

- P (Passenger)-Metric tire sizing is based on U.S. design standards. P-Metric tires have the letter “P” molded into the sidewall preceding the size designation. Example: P215/65R15 95H.

- European Metric tire sizing is based on European design standards. Tires designed to this standard have the tire size molded into the sidewall beginning with the section width. The letter "P" is absent from this tire size designation. Example: 215/65R15 96H
- LT (Light Truck)-Metric tire sizing is based on U.S. design standards. The size designation for LT-Metric tires is the same as for P-Metric tires except for the letters "LT" that are molded into the sidewall preceding the size designation. Example: LT235/85R16.
- Temporary Spare tires are high pressure compact spares designed for temporary emergency use only. Tires designed to this standard have the letter "T" molded into the sidewall preceding the size designation. Example: T145/80D18 103M.
- High Flotation tire sizing is based on U.S. design standards and begins with the tire diameter molded into the sidewall. Example: 31x10.5 R15 LT.

Tire Sizing Chart

EXAMPLE:
Size Designation: P = Passenger car tire size based on U.S. design standards "...blank..." = Passenger car tire based on European design standards LT = Light Truck tire based on U.S. design standards T = Temporary Spare tire 31 = Overall Diameter in Inches (in)
215 = Section Width in Millimeters (mm)
65 = Aspect Ratio in Percent (%) —Ratio of section height to section width of tire. 10.5 = Section Width in Inches (in)
R = Construction Code —"R" means Radial Construction. —"D" means Diagonal or Bias Construction.
15 = Rim Diameter in Inches (in)

EXAMPLE:**Service Description:**

95 = Load Index

—A numerical code associated with the maximum load a tire can carry.

H = Speed Symbol

—A symbol indicating the range of speeds at which a tire can carry a load corresponding to its load index under certain operating conditions.

—The maximum speed corresponding to the Speed Symbol should only be achieved under specified operating conditions. (i.e. tire pressure, vehicle loading, road conditions and posted speed limits).

Load Identification:

"...blank..." = Absence of any text on sidewall of the tire indicates a Standard Load (SL) Tire

Extra Load (XL) = Extra Load (or Reinforced) Tire

Light Load = Light Load Tire

C,D,E = Load range associated with the maximum load a tire can carry at a specified pressure

Maximum Load — Maximum Load indicates the maximum load this tire is designed to carry.

Maximum Pressure — Maximum Pressure indicates the maximum permissible cold tire inflation pressure for this tire.

Tire Identification Number (TIN)

The TIN may be found on one or both sides of the tire however the date code may only be on one side. Tires with white sidewalls will have the full TIN including date code located on the white sidewall side of the tire.

Look for the TIN on the outboard side of black sidewall tires as mounted on the vehicle. If the TIN is not found on the outboard side then you will find it on the inboard side of the tire.

EXAMPLE:	
DOT MA L9 ABCD 0301	
DOT = Department of Transportation	—This symbol certifies that the tire is in compliance with the U.S. Department of Transportation tire safety standards, and is approved for highway use.
MA = Code representing the tire manufacturing location. (2 digits)	
L9 = Code representing the tire size. (2 digits)	
ABCD = Code used by tire manufacturer. (1 to 4 digits)	
03 = Number representing the week in which the tire was manufactured. (2 digits)	—03 means the 3rd week.
01 = Number representing the year in which the tire was manufactured. (2 digits)	—01 means the year 2001. —Prior to July 2000, tire manufacturers were only required to have 1 number to represent the year in which the tire was manufactured. Example: 031 could represent the 3rd week of 1981 or 1991.

Tire Loading and Tire Pressure

Tire Placard Location

NOTE: The proper cold tire inflation pressure is listed on either the face of the driver's door or the driver's side "B" pillar.

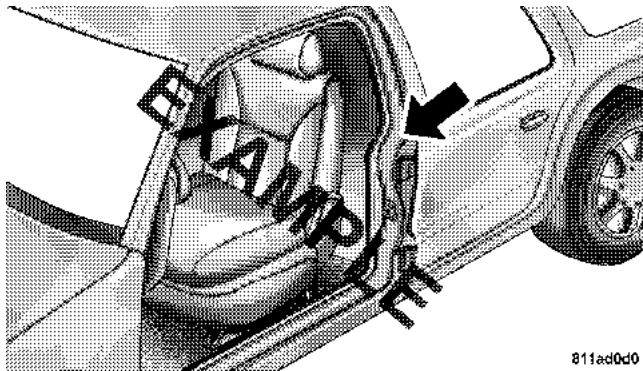

Tire Placard Location

811ad0d0

Tire and Loading Information Placard

TIRE AND LOADING INFORMATION

SEATING CAPACITY - TOTAL 5 FRONT 2 REAR 3

THE COMBINED WEIGHT OF OCCUPANTS AND CARGO SHOULD NOT EXCEED XXX KG OR XXX LBS.

TIRE	FRONT	REAR	SPARE
ORIGINAL TIRE SIZE	P195/70R14	P195/70R14	T125/70D15
COLD TIRE INFLATION PRESSURE	200kPa, 29PSI	200kPa, 29PSI	420kPa, 60PSI

SEE OWNER'S MANUAL FOR ADDITIONAL INFORMATION

4N109268

5

Tire and Loading Information

811b5a9a

This placard tells you important information about the:

- 1) number of people that can be carried in the vehicle
- 2) the total weight your vehicle can carry
- 3) the tire size designed for your vehicle
- 4) the cold tire inflation pressures for the front, rear and spare tires.

Loading

The vehicle maximum load on the tire must not exceed the load carrying capacity of the tire on your vehicle. You will not exceed the tire's load carrying capacity if you adhere to the loading conditions, tire size, and cold tire inflation pressures specified on the "Tire and Loading Information" placard and in the "Vehicle Loading" section of this manual.

NOTE: Under a maximum loaded vehicle condition, gross axle weight ratings (GAWR's) for the front and rear axles must not be exceeded. For further information on GAWR's, vehicle loading, and trailer towing, refer to the "Vehicle Loading" section of this manual.

To determine the maximum loading conditions of your vehicle, locate the statement "The combined weight of occupants and cargo should never exceed XXX kg or XXX lbs." on the Tire and Loading Information placard. The combined weight of occupants, cargo/luggage and trailer tongue weight (if applicable) should never exceed the weight referenced here.

Steps for Determining Correct Load Limit

1. Locate the statement "The combined weight of occupants and cargo should never exceed XXX pounds" on your vehicle's placard.
2. Determine the combined weight of the driver and passengers that will be riding in your vehicle.
3. Subtract the combined weight of the driver and passengers from XXX kilograms or XXX pounds.
4. The resulting figure equals the available amount of cargo and luggage load capacity. For example, if "XXX" amount equals 1400 lbs. and there will be five 150 lb. passengers in your vehicle, the amount of available cargo and luggage load capacity is 650 lb. (since $5 \times 150 = 750$, and $1400 - 750 = 650$ lb.)

5. Determine the combined weight of luggage and cargo being loaded on the vehicle. That weight may not safely exceed the available cargo and luggage load capacity calculated in Step 4.

6. If your vehicle will be towing a trailer, load from your trailer will be transferred to your vehicle. Consult this manual to determine how this reduces the available cargo and luggage load capacity of your vehicle.

NOTE: The following table shows examples on how to calculate total load, cargo/luggage and towing capacities of your vehicle with varying seating configurations and number and size of occupants. This table is for illustration purposes only and may not be accurate for the seating and load carry capacity of your vehicle.

NOTE: For the following example the combined weight of occupants and cargo should never exceed 865 lbs. (392 Kg).

310 STARTING AND OPERATING

Occupants			Combined weight of occupants and cargo from Tire Placard	MINUS	Combined Occupant's weight	=	AVAILABLE Cargo/Luggage and Trailer Tongue Weight
TOTAL	FRONT	REAR					
<u>EXAMPLE 1</u>			865 lbs	minus	670 lbs	=	195 lbs
5	2	3					
<u>EXAMPLE 2</u>			865 lbs	minus	540 lbs	=	325 lbs
3	2	1					
<u>EXAMPLE 3</u>			865 lbs	minus	400 lbs	=	465 lbs
2	2	0					

EXAMPLE

Occupant 1: 200 lbs
 Occupant 2: 130 lbs
 Occupant 3: 160 lbs
 Occupant 4: 100 lbs
 Occupant 5: 80 lbs
 TOTAL WEIGHT: 670 lbs

Occupant 1: 210 lbs
 Occupant 2: 180 lbs
 Occupant 3: 150 lbs
 TOTAL WEIGHT: 540 lbs

Occupant 1: 200 lbs
 Occupant 2: 200 lbs
 TOTAL WEIGHT: 400 lbs

WARNING!

Overloading of your tires is dangerous. Overloading can cause tire failure, affect vehicle handling, and increase your stopping distance. Use tires of the recommended load capacity for your vehicle. Never overload them.

TIRES—GENERAL INFORMATION**Tire Pressure**

Proper tire inflation pressure is essential to the safe and satisfactory operation of your vehicle. Three primary areas are affected by improper tire pressure:

1. Safety—**WARNING!**

Improperly inflated tires are dangerous and can cause accidents.

- Under inflation increases tire flexing and can result in tire failure.
- Over inflation reduces a tire's ability to cushion shock. Objects on the road and chuck holes can cause damage that results in tire failure.
- Unequal tire pressures can cause steering problems. You could lose control of your vehicle.
- Over inflated or under inflated tires can affect vehicle handling and can fail suddenly, resulting in loss of vehicle control.
- Unequal tire pressures from one side of the vehicle to the other can cause the vehicle to drift to the right or left.

Always drive with each tire inflated to the recommended cold tire inflation pressure.

2. *Economy*—

Improper inflation pressures can cause uneven wear patterns to develop across the tire tread. These abnormal wear patterns will reduce tread life resulting in a need for earlier tire replacement. Underinflation also increases tire rolling resistance and results in higher fuel consumption.

3. *Ride Comfort and Vehicle Stability*—

Proper tire inflation contributes to a comfortable ride. Overinflation produces a jarring and uncomfortable ride.

Tire Inflation Pressures

The proper cold tire inflation pressure is listed on either the face of the driver's door or the driver's side "B" pillar.

Some vehicles may have Supplemental Tire Pressure Information for vehicle loads that are less than the maximum loaded vehicle condition. These pressure conditions will be found in the "Supplemental Tire Pressure Information" section of this manual.

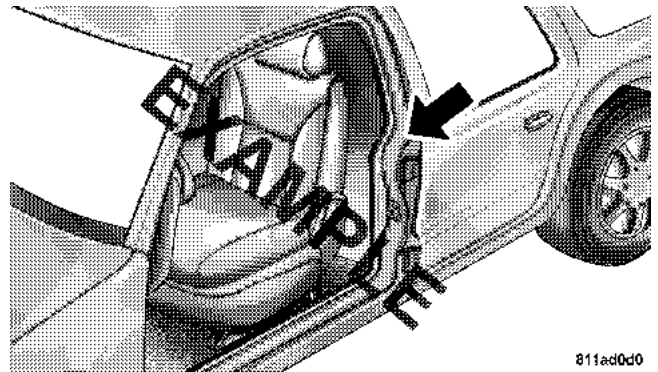

811ad0d0

Tire Placard Location

The pressure should be checked and adjusted as well as inspecting for signs of tire wear or visible damage at least once a month. Use a good quality pocket-type gauge to check tire pressure. Do not make a visual judgement when determining proper inflation. Radial tires may look properly inflated even when they are under inflated.

CAUTION!

After inspecting or adjusting the tire pressure, always reinstall the valve stem cap—if equipped. This will prevent moisture and dirt from entering the valve stem, which could damage the valve stem.

Inflation pressures specified on the placard are always “cold tire inflation pressure”. Cold tire inflation pressure is defined as the tire pressure after the vehicle has not been driven for at least 3 hours, or driven less than 1 mile (1 km) after a 3 hour period. The cold tire inflation pressure must not exceed the maximum inflation pressure molded into the tire side wall.

Check tire pressures more often if subject to a wide range of outdoor temperatures, as tire pressures vary with temperature changes.

Tire pressures change by approximately 1 psi (7 kPa) per 12° F (7° C) of air temperature change. Keep this in mind when checking tire pressure inside a garage, especially in the winter.

Example: If garage temperature = 68° F (20° C) and the outside temperature = 32° F (0° C) then the cold tire inflation pressure should be increased by 3 psi (21 kPa), which equals 1 psi (7 kPa) for every 12° F (7° C) for this outside temperature condition.

Tire pressure may increase from 2 to 6 psi (13 to 40 kPa) during operation. DO NOT reduce this normal pressure build up or your tire pressure will be too low.

Tire Pressures for High Speed Operation

The manufacturer advocates driving at safe speeds within posted speed limits. Where speed limits or conditions are such that the vehicle can be driven at high speeds, maintaining correct tire inflation pressure is very important. Increased tire pressure and reduced vehicle

loading may be required for high speed vehicle operation. Refer to original equipment or an authorized tire dealer for recommended safe operating speeds, loading and cold tire inflation pressures.

WARNING!

High speed driving with your vehicle under maximum load is dangerous. The added strain on your tires could cause them to fail. You could have a serious accident. Don't drive a vehicle loaded to the maximum capacity at continuous speeds above 75 mph (120 km/h).

Radial-Ply Tires**WARNING!**

Combining radial ply tires with other types of tires on your vehicle will cause your vehicle to handle poorly. The instability could cause an accident. Always use radial ply tires in sets of four (or 6, in case of trucks with dual rear wheels). Never combine them with other types of tires.

Cuts and punctures in radial tires are repairable only in the tread area because of sidewall flexing. Consult your authorized tire dealer for radial tire repairs.

Compact Spare Tire — If Equipped

The compact spare is for temporary emergency use with radial tires. It is engineered to be used on your style vehicle only. Since this tire has limited tread life, the original tire should be repaired (or replaced) and reinstalled at the first opportunity.

WARNING!

Temporary use spare tires are for emergency use only. With these tires, do not drive more than 50 mph (80 km/h). Temporary-use spare tires have limited tread life. When the tread is worn to the tread wear indicators, the temporary use spare tire needs to be replaced. Be sure to follow the warnings which apply to your spare. Failure to do so could result in spare tire failure and loss of vehicle control.

Do not install a wheel cover or attempt to mount a conventional tire on the compact spare wheel, since the wheel is designed specifically for the compact spare.

Do not install more than one compact spare tire/wheel on the vehicle at any given time.

CAUTION!

Because of the reduced ground clearance, do not take your vehicle through an automatic car wash with the compact spare installed. Damage to the vehicle may result.

Limited Use Spare — If Equipped

The limited use spare tire is for temporary emergency use on your vehicle. This tire is identified by a limited use spare tire warning label located on the limited use spare tire and wheel assembly. This tire may look like the original equipped tire on the front or rear axle of your vehicle, but it is not. Installation of this limited use spare tire affects vehicle handling. Since it is not the same tire, replace (or repair) the original tire and reinstall on the vehicle at the first opportunity.

WARNING!

The limited use spare tires are for emergency use only. Installation of this limited use spare tire affects vehicle handling. With this tire, do not drive more than 60 mph (100 km/h). Keep inflated to the cold tire inflation pressure listed on either your tire placard or limited use spare tire and wheel assembly. Replace (or repair) the original tire at the first opportunity and reinstall it on your vehicle. Failure to do so could result in loss of vehicle control.

Tire Spinning

When stuck in mud, sand, snow, or ice conditions, do not spin your vehicle's wheels above 35 mph (55 km/h).

See the paragraph on Freeing A Stuck Vehicle in Section 6 of this manual.

WARNING!

Fast spinning tires can be dangerous. Forces generated by excessive wheel speeds may cause tire damage or failure. A tire could explode and injure someone. Do not spin your vehicle's wheels faster than 35 mph (55 km/h) when you are stuck. And don't let anyone near a spinning wheel, no matter what the speed.

Tread Wear Indicators

Tread wear indicators are in the original equipment tires to help you in determining when your tires should be replaced.

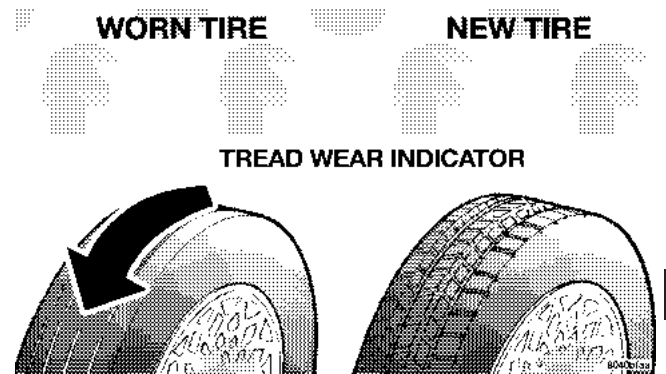

These indicators are molded into the bottom of the tread grooves and will appear as bands when the tread depth becomes 1/16 inch (2 mm). When the tread is worn to the tread wear indicators, the tire should be replaced.

Many states have laws requiring tire replacement at this point.

Life of Tire

The service life of a tire is dependent upon varying factors including but not limited to:

- Driving style
- Tire pressure
- Distance driven

WARNING!

Tires and spare tire should be replaced after six years, regardless of the remaining tread. Failure to follow this warning can result in sudden tire failure. You could lose control and have an accident resulting in serious injury or death.

Keep unmounted tires in a cool, dry place with as little exposure to light as possible. Protect tires from contact with oil, grease and gasoline.

Replacement Tires

The tires on your new vehicle provide a balance of many characteristics. They should be inspected regularly for wear and correct cold tire inflation pressure. The manufacturer strongly recommends that you use tires equivalent to the originals in size, quality and performance when replacement is needed (see the paragraph on tread wear indicators). Refer to the Tire and Loading Information placard for the size designation of your tire. The service description and load identification will be found on the original equipment tire. Failure to use equivalent replacement tires may adversely affect the safety, handling, and ride of your vehicle. We recommend that you contact your original equipment or an authorized tire dealer with any questions you may have on tire specifications or capability.

WARNING!

- Do not use a tire, wheel size or rating other than that specified for your vehicle. Some combinations of unapproved tires and wheels may change suspension dimensions and performance characteristics, resulting in changes to steering, handling, and braking of your vehicle. This can cause unpredictable handling and stress to steering and suspension components. You could lose control and have an accident resulting in serious injury or death. Use only the tire and wheel sizes with load ratings approved for your vehicle.
- Never use a tire with a smaller load index or capacity, other than what was originally equipped on your vehicle. Using a tire with a smaller load index could result in tire overloading and failure. You could lose control and have an accident.
- Failure to equip your vehicle with tires having adequate speed capability can result in sudden tire failure and loss of vehicle control.

CAUTION!

Replacing original tires with tires of a different size may result in false speedometer and odometer readings.

Alignment And Balance

Poor suspension alignment may result in:

- Fast tire wear.
- Uneven tire wear, such as feathering and one-sided wear.
- Vehicle pull to right or left.

Tires may also cause the vehicle to pull to the left or right. Alignment will not correct this condition. See your dealer for proper diagnosis.

Improper alignment will not cause vehicle vibration. Vibration may be a result of tire and wheel out-of-balance. Proper balancing will reduce vibration and avoid tire cupping and spotty wear.

TIRE CHAINS

Due to limited clearance, tire chains are not recommended.

CAUTION!

Damage to the vehicle may result if tire chains are used.

SNOW TIRES

Some areas of the country require the use of snow tires during winter. Standard tires are of the all season type and satisfy this requirement as indicated by the M+S designation on the tire side wall.

If you need snow tires, select tires equivalent in size and type to the original equipment tires. Use snow tires only in sets of 4, failure to do so may adversely affect the safety and handling of your vehicle.

Snow tires generally have lower speed ratings than what was originally equipped with your vehicle and should not be operated at sustained speeds over 75 mph (120 km/h).

Tire Rotation Recommendations

Tires on the front and rear axles of vehicles operate at different loads and perform different steering, driving and braking functions. For these reasons, they wear at unequal rates, and tend to develop irregular wear patterns.

These effects can be reduced by timely rotation of tires. The benefits of rotation are especially worthwhile with aggressive tread designs such as those on all season type tires. Rotation will increase tread life, help to maintain mud, snow and wet traction levels, and contribute to a smooth, quiet ride.

Follow the recommended tire rotation frequency for your type of driving found in the "Maintenance Schedules" Section of this manual. More frequent rotation is permissible if desired. The reasons for any rapid or unusual

wear should be corrected before rotating. The suggested rotation method is the "forward-cross" shown in the diagram.

TIRE ROTATION PATTERN

← FRONT OF VEHICLE

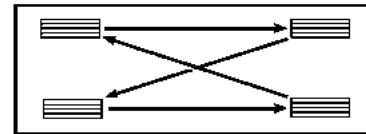

4 TIRE ROTATION

FUEL REQUIREMENTS

2.4L Standard Engine and 2.4L Standard Turbo Engine



Your vehicle is designed to meet all emission regulations and provide excellent fuel economy when using high quality regular unleaded gasoline with an octane rating of 87. The use of premium gasoline is not recommended. The use of premium gasoline will provide no benefit over high quality regular gasolines, and in some circumstances, may result in poorer performance.

2.4L High Output Turbo Engine



Your engine is designed to meet all emission regulations and provide excellent fuel economy and performance when using

high quality unleaded gasoline having an octane rating of 91. The purchase of higher octane is not required.

The use of high quality unleaded gasoline having an octane rating of 91 is recommended but not required. High quality unleaded gasoline having a minimum octane rating of 87 may safely be used for your vehicle. Use of these lower octane gasolines, however, may result in reduced acceleration performance.

Light spark knock at low engine speeds is not harmful to your engine. However, continued heavy spark knock at high speeds can cause damage and immediate service is required.

Poor quality gasoline can cause problems such as hard starting, stalling and hesitations. If you experience these symptoms, try another brand of gasoline (with the appropriate octane rating for your engine) before considering service for the vehicle.

Over 40 automobile manufacturers around the world have issued and endorsed consistent gasoline specifications (the World Wide Fuel Charter, WWFC) to define fuel properties necessary to deliver enhanced emissions, engine performance, and durability for your vehicle. The manufacturer recommends the use of gasolines that meet the WWFC specifications if they are available.

Reformulated Gasoline

Many areas of the country require the use of cleaner burning gasoline referred to as “Reformulated Gasoline”.

Reformulated gasolines contain oxygenates, and are specifically blended to reduce vehicle emissions and improve air quality.

The manufacturer supports the use of reformulated gasolines. Properly blended reformulated gasolines will provide excellent performance and durability of engine and fuel system components.

Gasoline/Oxygenate Blends

Some fuel suppliers blend unleaded gasoline with oxygenates such as 10% ethanol, MTBE, and ETBE. Oxygenates are required in some areas of the country during the winter months to reduce carbon monoxide emissions. Fuels blended with these oxygenates may be used in your vehicle.

CAUTION!

DO NOT use gasolines containing Methanol. Use of these blends may result in starting and driveability problems and may damage critical fuel system components.

Problems that result from using methanol/gasoline blends are not the responsibility of the manufacturer. While MTBE is an oxygenate made from Methanol, it does not have the negative effects of Methanol.

MMT In Gasoline

MMT is a manganese containing metallic additive that is blended into some gasoline to increase the octane number. Gasolines blended with MMT offer no performance advantage beyond gasolines of the same octane number without MMT. Gasolines blended with MMT have shown to reduce spark plug life and reduce emission system performance in some vehicles. The manufacturer recommends using gasolines without MMT. Since the MMT content of gasoline may not be indicated on the pump, you should ask your gasoline retailer whether or not his/her gasoline contains MMT.

It is even more important to look for gasolines without MMT in Canada, because MMT can be used at levels higher than those allowed in the United States.

MMT is prohibited in Federal and California reformulated gasolines.

Materials Added to Fuel

All gasoline sold in the United States is required to contain effective detergent additives. Use of additional detergents or other additives is not needed under normal conditions and would result in additional cost. Therefore you should not have to add anything to the fuel.

Fuel System Cautions

CAUTION!
Follow these guidelines to maintain your vehicle's performance:

- The use of leaded gas is prohibited by Federal law. Using leaded gasoline can impair engine performance, damage the emission control system.
- An out-of-tune engine, or certain fuel or ignition malfunctions, can cause the catalytic converter to

overheat. If you notice a pungent burning odor or some light smoke, your engine may be out of tune or malfunctioning and may require immediate service. Contact your dealer for service assistance.

- The use of fuel additives which are now being sold as octane enhancers is not recommended. Most of these products contain high concentrations of methanol. Fuel system damage or vehicle performance problems resulting from the use of such fuels or additives is not the responsibility of the manufacturer.

NOTE: Intentional tampering with emissions control systems can result in civil penalties being assessed against you.

Carbon Monoxide Warnings

WARNING!

Carbon monoxide (CO) in exhaust gases is deadly. Follow the precautions below to prevent carbon monoxide poisoning:

- Do not inhale exhaust gases. They contain carbon monoxide, a colorless and odorless gas which can kill. Never run the engine in a closed area, such as a garage, and never sit in a parked vehicle with the engine running for an extended period. If the vehicle is stopped in an open area with the engine running for more than a short period, adjust the ventilation system to force fresh, outside air into the vehicle.
- Guard against carbon monoxide with proper maintenance. Have the exhaust system inspected every time

the vehicle is raised. Have any abnormal conditions repaired promptly. Until repaired, drive with all side windows fully open.

- Keep the liftgate closed when driving your vehicle to prevent carbon monoxide and other poisonous exhaust gases from entering the vehicle.

ADDING FUEL

The fuel tank filler tube has a restricting door about 2 inches (50 mm) inside the opening. If using a portable container, it should have a flexible nozzle long enough to force open the restricting door.

Fuel Filler Cap (Gas Cap)

The gas cap is behind the fuel filler door, on the passenger's side of the vehicle. If the gas cap is lost or damaged, be sure the replacement cap is for use with this vehicle.

NOTE: When removing the fuel filler cap, lay the cap tether in the hook, located on the fuel filler cap door reinforcement.

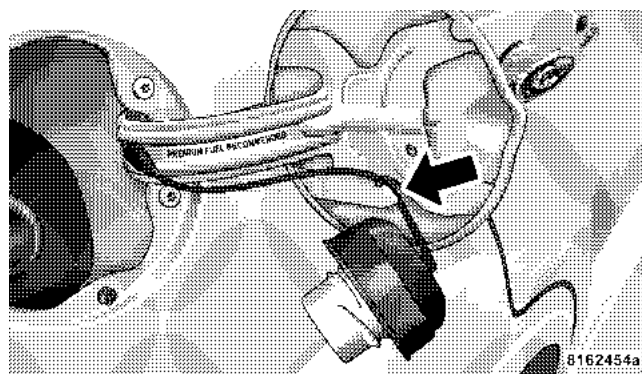

Gas Cap Tether Hook

CAUTION!

Damage to the fuel system or emission control system could result from using an improper fuel tank filler tube cap (gas cap). A poorly fitting cap could let impurities into the fuel system.

CAUTION!

A poorly fitting gas cap may cause the Malfunction Indicator Light to turn on.

CAUTION!

To avoid fuel spillage and overfilling, do not “top off” the fuel tank after filling.

NOTE: When the fuel nozzle “clicks” or shuts off, the fuel tank is full.

WARNING!

- Never have any smoking materials lit in or near the vehicle when the gas cap is removed or the tank filled.
- Never add fuel when the engine is running. This is in violation of most state and federal fire regulations and will cause the malfunction indicator light to turn on.

NOTE: Tighten the gas cap about 1/4 turn until you hear one click. This is an indication that cap is properly tightened.

If the gas cap is not tighten properly, the Malfunction Indicator Light will come on. Be sure the gas cap is tightened every time the vehicle is refueled.

WARNING!

A fire may result if gasoline is pumped into a portable container that is inside of a vehicle. You could be burned. Always place gas containers on the ground while filling.

Loose Fuel Filler Cap Message

If the vehicle diagnostic system determines that the fuel filler cap is loose, improperly installed, or damaged, a “gASCAP” message will be displayed in the Odometer/Trip Odometer in the instrument cluster. Refer to “Instrument Cluster Description” in Section 3 of this manual. Tighten the fuel filler cap properly and press the odometer/trip odometer reset button to turn the message off. If the problem continues, the message will appear the next time the vehicle is started. Refer to “Onboard Diagnostic System — OBDII” in Section 7 of this manual for more information.

CAUTION!

Damage to the fuel system or emission control system could result from using an improper fuel tank filler cap (gas cap). A poorly fitting cap could let impurities into the fuel system.

WARNING!

- Never add fuel when the engine is running.
- Never have any smoking materials lit in or near the vehicle when the fuel cap is removed or the tank filled.

VEHICLE LOADING

Vehicle Loading Capacities

Front Seat Occupants	2
Rear Seat Occupants (sedan)	3
Rear Seat Occupants (convertible)	2
Luggage	115 lbs (52 kg)
Rated Vehicle Capacity (sedan)	865 lb (392 kg)
Rated Vehicle Capacity (convertible)	715 lb (324 kg)

TRAILER TOWING

In this section you will find safety tips and information on limits to the type of towing you can reasonably do with your vehicle. Before towing a trailer carefully review this information to tow your load as efficiently and safely as possible.

To maintain warranty coverage, follow the requirements and recommendations in this manual concerning vehicles used for trailer towing.

Common Towing Definitions

The following trailer towing related definitions will assist you in understanding the following information:

Gross Vehicle Weight Rating (GVWR)

The GVWR is the total allowable weight of your vehicle. This includes driver, passengers, cargo and tongue weight. The total load must be limited so that you do not exceed the GVWR.

Gross Trailer Weight (GTW)

The gross trailer weight (GTW) is the weight of the trailer plus the weight of all cargo, consumables and equipment (permanent or temporary) loaded in or on the trailer in its "loaded and ready for operation" condition. The recommended way to measure GTW is to put your fully loaded trailer on a vehicle scale. The entire weight of the trailer must be supported by the scale.

Gross Combination Weight Rating (GCWR)

The gross combination weight rating (GCWR) is the total permissible weight of your vehicle and trailer when weighed in combination. (Note that GCWR ratings include a 68 kg (150 lbs) allowance for the presence of a driver).

Gross Axle Weight Rating (GAWR)

The GAWR is the maximum capacity of the front and rear axles. Distribute the load over the front and rear axles evenly. Make sure that you do not exceed either front or rear GAWR.

WARNING!

It is important that you do not exceed the maximum front or rear GAWR. A dangerous driving condition can result if either rating is exceeded. You could lose control of the vehicle and have an accident.

Tongue Weight (TW)

The downward force exerted on the hitch ball by the trailer. In most cases it should not be less than 10% or more than 15% of the trailer load. You must consider this as part of the load on your vehicle.

Frontal Area

The maximum height and maximum width of the front of a trailer.

Trailer Sway Control

The trailer sway control is a telescoping link that can be installed between the hitch receiver and the trailer tongue

that typically provides adjustable friction associated with the telescoping motion to dampen any unwanted trailer swaying motions while traveling.

Weight-Carrying Hitch

A weight-carrying hitch supports the trailer tongue weight, just as if it were luggage located at a hitch ball or some other connecting point of the truck. These kind of hitches are the most popular on the market today and they're commonly used to tow small- and medium-sized trailers.

Weight-Distributing Hitch

A weight-distributing hitch includes a receiver attached to the tow vehicle, plus a removable hitch head and spring bar assembly that fits into the receiver opening and hook up brackets that connect the spring bars to the trailer frame.

Trailer Hitch Classification

The rear bumper is intended to tow trailers up to 2,000 lbs (907 kg) without added equipment or alterations to the standard equipment. Your vehicle may be factory equipped for safe towing of trailers weighing over 2,000 lbs (907 kg) with the optional Trailer Tow Prep Package. See your dealer for package content.

The following chart provides the industry standard for the maximum trailer weight a given trailer hitch class can tow and should be used to assist you in selecting the correct trailer hitch for your intended towing condition. Refer to the Trailer Towing Weights (Maximum Trailer Weight Ratings) chart for the Max. GTW towable for your given drivetrain.

Trailer Hitch Classification	
Class	Max. GTW (Gross Trailer Wt.)
Class I - Light Duty	2,000 lbs (907 kg)
Class II - Medium Duty	3,500 lbs (1587 kg)
Class III - Heavy Duty	5,000 lbs (2268 kg)
Class IV - Extra Heavy Duty	10,000 lbs (4540 kg)

All trailer hitches should be professionally installed on your vehicle.

Trailer Towing Weights (Maximum Trailer Weight Ratings)

The following chart provides the maximum trailer weight ratings towable for your given drivetrain.

Engine/Transmission	Frontal Area	Max. GTW (Gross Trailer Wt.)	Max. Tongue Wt. (See Note 1)
2.4L N/A and 2.4L Turbo/Automatic*	20 Sq. Ft	1000 lbs (454 kg)	110 lbs (50 kg)
2.4L N/A and 2.4L Turbo/Manual*	20 Sq. Ft.	1000 lbs (454 kg)	110 lbs (50 kg)
* N/A (Naturally Aspirated)			
Refer to local laws for maximum trailer towing speeds.			

Note 1 – The trailer tongue weight must be considered as part of the combined weight of occupants and cargo, and should never exceed the weight referenced on the Tire and Loading Information placard. Refer to the Tire-Safety Information Section in this manual.

Trailer and Tongue Weight

Always load a trailer with 60% to 65% of the weight in the front of the trailer. This places 10% to 15% of the Gross Trailer Weight (GTW) on the tow hitch of your vehicle. Loads balanced over the wheels or heavier in the

rear can cause the trailer to sway **severely** side to side which will cause loss of control of vehicle and trailer. Failure to load trailers heavier in front is the cause of many trailer accidents.

Never exceed the maximum tongue weight stamped on your bumper or trailer hitch.

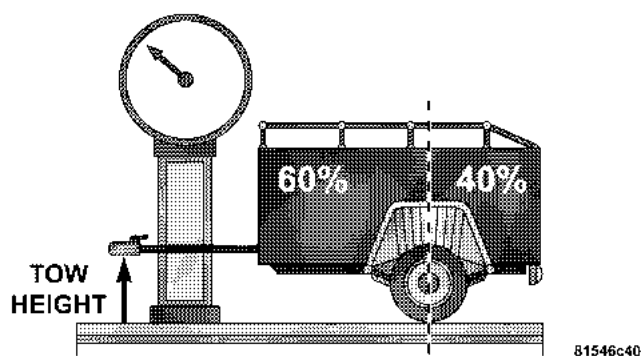

Consider the following items when computing the weight on the rear axle of the vehicle:

- The tongue weight of the trailer.
- The weight of any other type of cargo or equipment put in or on your vehicle.
- The weight of the driver and all passengers.

NOTE: Remember that everything put into or on the trailer adds to the load on your vehicle. Also, additional factory-installed options, or dealer-installed options, must be considered as part of the total load on your vehicle. Refer to the Tire and Loading Information placard in the Tire Safety Information Section of this manual for the maximum combined weight of occupants and cargo for your vehicle.

Trailer sway control and a weight distributing (load equalizing) hitch are recommended for Tongue Weights (TW) above 150 lbs (68 kg) and required for Tongue Weights above 300 lbs (136 kg).

Towing Requirements

To promote proper break-in of your new vehicle drivetrain components the following guidelines are recommended:

CAUTION!

- Avoid towing a trailer for the first 500 miles (805 km) of vehicle operation. Doing so may damage your vehicle.
- During the first 500 miles (805 km) of trailer towing, limit your speed to 50 mph (80 km/h).

Perform the maintenance listed in Section 8 of this manual. When towing a trailer, never exceed the GAWR, or GCWR, ratings.

WARNING!

Improper towing can lead to an injury accident. Follow these guidelines to make your trailer towing as safe as possible:

Make certain that the load is secured in the trailer and will not shift during travel. When trailering cargo that is not fully secured, dynamic load shifts can occur that may be difficult for the driver to control. You could lose control of your vehicle and have an accident.

- When hauling cargo or towing a trailer, do not overload your vehicle or trailer. Overloading can cause a loss of control, poor performance or damage to brakes, axle, engine, transmission, steering, suspension, chassis structure or tires.

- Safety chains must always be used between your vehicle and trailer. Always connect the chains to the frame or hook retainers of the vehicle hitch. Cross the chains under the trailer tongue and allow enough slack for turning corners.
- Vehicles with trailers should not be parked on a grade. When parking, apply the parking brake on the tow vehicle. Put the tow vehicle automatic transmission in P for Park. With a manual transmission, shift the transmission into reverse. Always, block or "chock" the trailer wheels.
- GCWR must not be exceeded.
- **Total weight must be distributed between the tow vehicle and the trailer such that the following four ratings are not exceeded:**
 1. GVWR
 2. GTW

3. GAWR

4. Tongue weight rating for the trailer hitch utilized (This requirement may limit the ability to always achieve the 10% to 15% range of tongue weight as a percentage of total trailer weight).

Towing Requirements — Tires

- Do not attempt to tow a trailer while using a compact spare tire.
- Proper tire inflation pressures are essential to the safe and satisfactory operation of your vehicle. Refer to the Tires–General Information section of this manual on Tire Pressures for proper tire inflation procedures.
- Also, check the trailer tires for proper tire inflation pressures before trailer usage.
- Check for signs of tire wear or visible tire damage before towing a trailer. Refer to the Tires–General

Information section of this manual on Tread Wear Indicators for the proper inspection procedure.

- When replacing tires refer to the Tires–General Information section of this manual on Replacement Tires for proper tire replacement procedures. Replacing tires with a higher load carrying capacity will not increase the vehicle’s GVWR and GAWR limits.

Towing Requirements — Trailer Brakes

- Do **not** interconnect the hydraulic brake system or vacuum system of your vehicle with that of the trailer. This could cause inadequate braking and possible personal injury.
- An electronically actuated trailer brake controller is required when towing a trailer with electronically actuated brakes. When towing a trailer equipped with a hydraulic surge actuated brake system, an electronic brake controller is not required.

- Trailer brakes are recommended for trailers over 1,000 lbs (454 kg) and required for trailers in excess of 2,000 lbs (907 kg).

CAUTION!

If the trailer weighs more than 1,000 lbs (454 kg) loaded, it should have its own brakes and they should be of adequate capacity. Failure to do this could lead to accelerated brake lining wear, higher brake pedal effort, and longer stopping distances.

WARNING!

Do not connect trailer brakes to your vehicle's hydraulic brake lines. It can overload your brake system and cause it to fail. You might not have brakes when you need them and could have an accident.

Towing any trailer will increase your stopping distance. When towing you should allow for additional space between your vehicle and the vehicle in front of you. Failure to do so could result in an accident.

Towing Requirements — Trailer Lights & Wiring

Whenever you pull a trailer, regardless of the trailer size, stop lights and turn signals on the trailer are required for motoring safety.

The Trailer Tow Package may include a 4 and 7 pin wiring harness. Use a factory approved trailer harness and connector.

NOTE: Do not cut or splice wiring into the vehicles wiring harness.

The electrical connections are all complete to the vehicle but you must mate the harness to a trailer connector. Refer to the following illustrations.

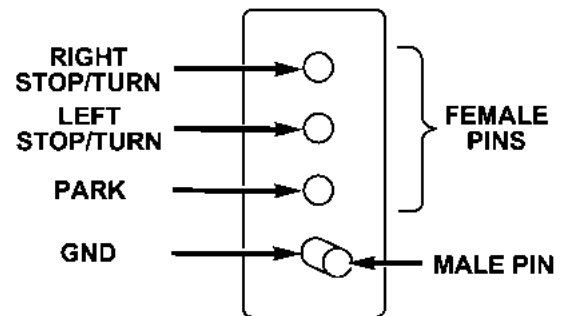

4 - Pin Connector

813262be

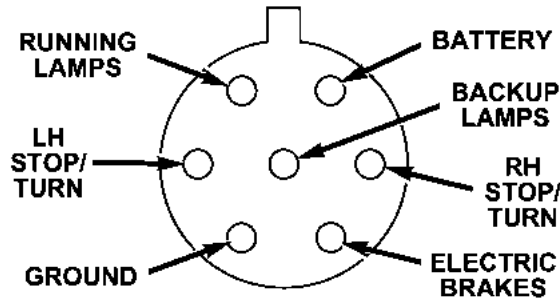

812634c6

7- Pin Connector

Towing Tips

Before setting out on a trip, practice turning, stopping and backing the trailer in an area away from heavy traffic.

If using a manual transmission vehicle for trailer towing, all starts must be in FIRST gear to avoid excessive clutch slippage.

Towing Tips — Automatic Transmission

The "D" range can be selected when towing. However, if frequent shifting occurs while in this range, the "3" range should be selected.

NOTE: Using the "3" range while operating the vehicle under heavy operating conditions will improve performance and extend transmission life by reducing excessive shifting and heat build up. This action will also provide better engine braking.

The automatic transmission fluid and filter should be changed if you REGULARLY tow a trailer for more than 45 minutes of continuous operation. See Schedule "B" in section 8 of this manual for transmission fluid change intervals.

NOTE: Check the automatic transmission fluid level before towing.

Towing Tips — Electronic Speed Control (If Equipped)

- Don't use in hilly terrain or with heavy loads.
- When using the speed control, if you experience speed drops greater than 10 mph (16 km/h), disengage until you can get back to cruising speed.
- Use speed control in flat terrain and with light loads to maximize fuel efficiency.

Towing Tips — Cooling System

To reduce potential for engine and transmission overheating, take the following actions:

– City Driving

While stopped, put transaxle in neutral, but do not increase engine idle speed.

– Highway Driving

Reduce speed.

– Air Conditioning

Turn off temporarily.

- refer to Cooling System Operating information in the Maintenance section of this manual for more information.

RECREATIONAL TOWING (BEHIND MOTORHOME, ETC.)

Towing This Vehicle Behind Another Vehicle (Flat towing with all four wheels on the ground)

Recreational towing on vehicle's equipped with automatic transaxle's is not recommended.

NOTE: If the vehicle requires towing make sure all four wheels are off the ground.

If your vehicle is equipped with a manual transaxle, it may be towed with all four wheels on the ground, in a forward direction, at any legal highway speed, for any distance, if the transaxle is in neutral.

WHAT TO DO IN EMERGENCIES

CONTENTS

■ Hazard Warning Flasher344	■ Driving On Slippery Surfaces353
■ If Your Engine Overheats344	□ Acceleration353
■ Jacking And Tire Changing346	□ Traction354
□ Jack Location347	■ Freeing A Stuck Vehicle354
□ Spare Tire Stowage347	■ Towing A Disabled Vehicle355
□ Preparations For Jacking348	□ With Ignition Key355
□ Jacking Instructions349	□ Without The Ignition Key356
■ Jump-Starting Procedures Due To A Low Battery351	■ Convertible Top Manual Override357

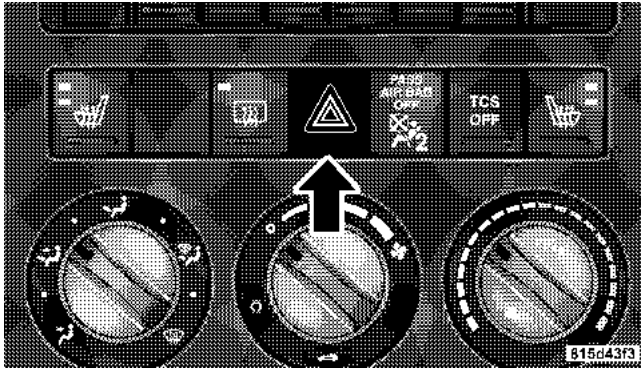
HAZARD WARNING FLASHER

Hazard Warning Switch

 The flasher switch is located on the instrument panel, below the radio. Depress the switch and both cluster indicators and all front and rear directional signals will flash. Depress the switch again to turn Hazard Warning Flashers off.

Do not use this emergency warning system when the vehicle is in motion. Use it when your vehicle is disabled and is creating a safety hazard for other motorists.

If it is necessary to leave the vehicle to go for service, the flasher system will continue to operate with the ignition key removed and the vehicle locked.

NOTE: With extended use, the flasher may wear down your battery.

IF YOUR ENGINE OVERHEATS

In any of the following situations, you can reduce the potential for overheating by taking the appropriate action.

- On the highways — Slow down.
- In city traffic — While stopped, put transaxle in neutral, but do not increase engine idle speed.

If the pointer rises to the **H** (red) mark, the instrument cluster will sound a chime. Pull over and stop the vehicle with the engine at idle, when safe. Turn off the air conditioning and wait until the pointer drops back into the normal range. If the pointer remains on the H (red) mark for more than a minute, turn the engine off immediately and call for service.

NOTE: There are steps that you can take to slow down an impending overheat condition. If your air conditioner is on, turn it off. The air conditioning system adds heat to the engine cooling system and turning off the A/C removes this heat. You can also turn the Temperature control to maximum heat, the Mode control to floor, and the fan control to High. This allows the heater core to act as a supplement to the radiator and aids in removing heat from the engine cooling system.

CAUTION!

Driving with a hot cooling system could damage your vehicle. If temperature gauge reads "H", pull over and stop the vehicle with the engine at idle, when safe. Turn the air conditioner off and wait until the pointer drops back into the normal range. After appropriate action has been taken, if the pointer remains on the "H", turn the engine off immediately, and call for service.

WARNING!

A hot engine cooling system is dangerous. You or others could be badly burned by steam or boiling coolant. You may want to call a service center if your vehicle overheats. If you decide to look under the hood yourself, refer to Section 7, Maintenance, of this manual. Follow the warnings under the Cooling System Pressure Cap paragraph.

JACKING AND TIRE CHANGING**WARNING!**

- Being under a jacked-up vehicle is dangerous. The vehicle could slip off the jack and fall on you. You could be crushed. Never put any part of your body under a vehicle that is on a jack. Never start or run the engine while the vehicle is on a jack. If you need to get under a raised vehicle, take it to a service center where it can be raised on a lift.
- The jack is designed to use as a tool for changing tires only. The jack should not be used to lift the vehicle for service purposes. The vehicle should be jacked on a firm level surface only. Avoid ice or slippery areas.

Jack Location

The jack and jack-handle are stowed behind the right rear side trim panel in the cargo area.

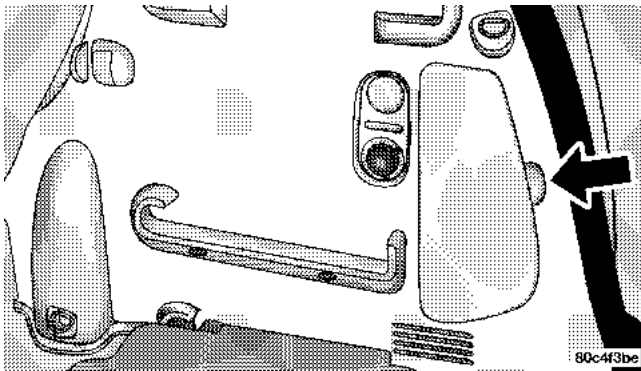

Jack Location

Do not attempt to raise this vehicle using a bumper jack.

Spare Tire Stowage

The compact spare tire is stowed under the rear of the vehicle by means of a hook/basket mechanism. To remove or stow the compact spare, use the jack handle to rotate the "spare tire drive" nut. The nut is located under the rear scuff plate at the right rear of the cargo area, just inside the liftgate opening.

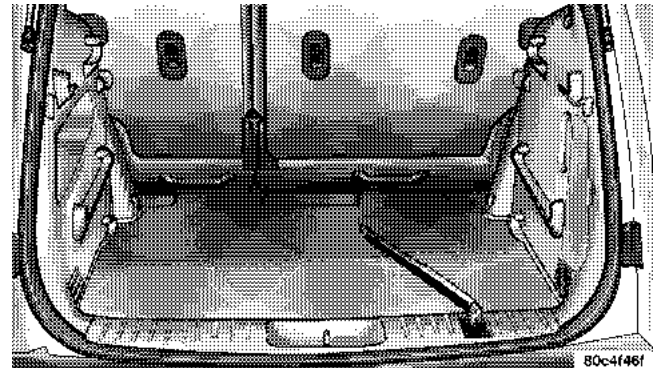

Lowering Spare Tire

Spare Tire Removal

Lift up the cover and fit the jack-handle over the drive nut. Rotate the nut to the left until you can remove the swivel hook from the stowage basket. Swing the basket down to remove the compact spare tire.

CAUTION!

The hook is designed for use with the jack handle only. Use of an air wrench or other power tools is not recommended and can damage the winch.

Preparations For Jacking

Park the vehicle on a firm level surface, avoid ice or slippery areas, **set the parking brake** and place the gear selector in PARK (automatic transaxle) or REVERSE (manual transaxle). Turn OFF the ignition.

WARNING!

Do not attempt to change a tire on the side of the vehicle close to moving traffic. Pull far enough off the road to avoid the danger of being hit when operating the jack or changing the wheel.

- Turn on the Hazard Warning Flasher.

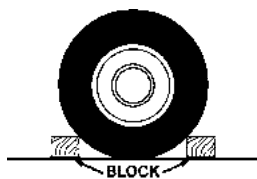

- Block both the front and rear of the wheel diagonally opposite the jacking position. For example, if changing the right front tire, block the left rear wheel.
- Passengers should not remain in the vehicle while the vehicle is being jacked.

Jacking Instructions

1. Remove the scissors jack and lug wrench from the stowage bag.

NOTE: If equipped with a center cap that covers the wheel nuts, pry off the cap using the small end of the lug wrench. To reinstall the cap, make sure it is properly lined up before pushing it on to the wheel.

2. Loosen, but do not remove, the wheel nuts by turning them to the left one turn while the wheel is still on the ground.

3. There are two front jacking locations on each side of the body and rear jacking locations located on the trailing arm bracket under the triangular cut out symbol. Turn the jack screw to the right until the jack head is properly engaged with the lift area closest to the wheel to be changed.

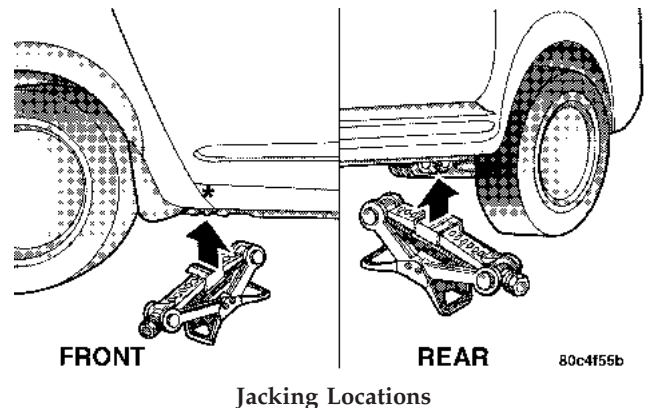

CAUTION!

Do not attempt to raise the vehicle by jacking on the crossmember below the radiator, on the front suspension crossmember, or on the rear axle assembly.

Do not raise the vehicle until you are sure the jack is securely engaged.

4. Raise the vehicle by turning the jack screw to the right, using the swivel wrench. Raise the vehicle only until the tire just clears the surface and enough clearance is obtained to install the spare tire. Minimum tire lift provides maximum stability.

WARNING!

Raising the vehicle higher than necessary can make the vehicle less stable. It could slip off the jack and hurt someone near it. Raise the vehicle only enough to remove the tire.

5. Remove the wheel nuts and pull the wheel and wheel covers where applicable off the hub. Install the spare wheel and wheel nuts with the cone shaped end of the

nuts toward the wheel. Lightly tighten the nuts. To avoid the risk of forcing the vehicle off the jack, do not tighten the nuts fully until the vehicle has been lowered.

WARNING!

To avoid possible personal injury, handle the wheel covers with care to avoid contact with any sharp edges.

NOTE: The wheel cover is held on the wheel by the wheel nuts. When reinstalling original wheel, properly align the wheel cover to the valve stem, place the wheel cover onto the wheel, then install the wheel nuts.

6. Lower the vehicle by turning the jack screw to the left.

7. Finish tightening the nuts. Push down on the wrench while tightening the wheel nuts. Alternate nuts until each nut has been tightened twice. Correct wheel nut torque is

100 ft. lbs (135 N·m). If you doubt that you have tightened the nuts correctly, have them checked with a torque wrench by your dealer or at a service station.

8. Remove the wheel blocks and lower the jack until it is free. Stow the lug wrench, and jack in their designated location. Secure all parts using the means provided.

WARNING!

A loose tire or jack thrown forward in a collision or hard stop could endanger the occupants of the vehicle. Always stow the jack parts and the spare tire in the places provided.

9. Place the deflated (flat) tire in the cargo area, have the tire repaired or replaced as soon as possible.

WARNING!

A loose tire thrown forward in a collision or hard stop could injure the occupants in the vehicle. Have the deflated (flat) tire repaired or replaced immediately.

10. Check the tire pressure as soon as possible. Correct pressure as required.

JUMP-STARTING PROCEDURES DUE TO A LOW BATTERY

6

WARNING!

Take care to avoid the radiator cooling fan whenever the hood is raised. It can start anytime the ignition switch is on. You can be hurt by the fan.

WARNING!

Do not attempt to push or tow your vehicle to get it started. Vehicles equipped with an automatic transaxle cannot be started this way. Unburned fuel could enter the catalytic converter and once the engine has started, ignite and damage the converter and vehicle. If the vehicle has a discharged battery, booster cables may be used to obtain a start from another vehicle. This type of start can be dangerous if done improperly, so follow this procedure carefully.

1. Wear eye protection and remove any metal jewelry such as watch bands or bracelets that might make an inadvertent electrical contact.

2. When boosting from a battery in another vehicle, park that vehicle within booster cable reach but without letting the vehicles touch. Set parking brake, place automatic transaxle in PARK (manual transaxle in NEUTRAL) and turn ignition to OFF for both vehicles.

3. Turn off the heater, radio and all unnecessary electrical loads.

4. Connect one end of a jumper cable to the positive terminal of the booster battery. Connect the other end of the jumper cable to the positive terminal of the discharged battery.

WARNING!

Battery fluid is a corrosive acid solution; do not allow battery fluid to contact eyes, skin or clothing. Don't lean over battery when attaching clamps or allow the clamps to touch each other. If acid splashes in eyes or on skin, flush the contaminated area immediately with large quantities of water.

A battery generates hydrogen gas which is flammable and explosive. Keep flame or spark away from the vent holes. Do not use a booster battery or any other booster source with an output that exceeds 12 volts.

5. Connect the other cable, first to the negative terminal of the booster battery and then to the negative terminal of the discharged battery. Make sure you have a good contact.

6. If the vehicle is equipped with Sentry Key Immobilizer, turn the ignition switch to the ON position for 3 seconds before moving the ignition switch to the START position.

7. Start the engine in the vehicle that has the booster battery, let the engine idle a few minutes, then start the engine in the vehicle with the discharged battery.

8. When removing the jumper cables, reverse the sequence exactly. Be careful of the moving belts and fan.

DRIVING ON SLIPPERY SURFACES**6****Acceleration**

Rapid acceleration on snow covered, wet, or other slippery surfaces may cause the front wheels to pull erratically to the right or left. This phenomenon occurs when there is a difference in the surface traction under the front (driving) wheels.

WARNING!

Rapid acceleration on slippery surfaces is dangerous. Unequal traction can cause sudden pulling of the front wheels. You could lose control of the vehicle and possibly have an accident. Accelerate slowly and carefully whenever there is likely to be poor traction (ice, snow, wet, mud, loose sand, etc.).

Traction

When driving on wet or slushy roads, it is possible for a wedge of water to build up between the tire and road surface. This is hydroplaning and may cause partial or complete loss of vehicle control and stopping ability. To reduce this possibility, the following precautions should be observed:

1. Slow down during rainstorms or when roads are slushy.

2. Slow down if road has standing water or puddles.

3. Replace tires when tread wear indicators first become visible.

4. Keep tires properly inflated.

5. Maintain enough distance between your vehicle and the vehicle in front of you to avoid a collision in a sudden stop.

FREEING A STUCK VEHICLE

NOTE: If your vehicle is equipped with Traction Control, turn the system OFF before attempting to “rock” the vehicle.

If your vehicle becomes stuck in mud, sand or snow, it can often be moved by a rocking motion. Turn your steering wheel right and left to clear the area around the front wheels. Then shift back and forth between Reverse

and First gear. Usually the least accelerator pedal pressure to maintain the rocking motion without spinning the wheels is most effective.

WARNING!

Fast spinning tires can be dangerous. Forces generated by excessive wheel speeds may cause tire damage or failure. A tire could explode and injure someone. Do not spin your vehicle's wheels faster than 35 mph (55km/h) when you are stuck. And don't let anyone near a spinning wheel, no matter what the speed.

CAUTION!

Racing the engine or spinning the wheels too fast may lead to transaxle overheating and failure. It can also damage the tires. Do not spin the wheels above 35 mph (55km/h).

TOWING A DISABLED VEHICLE

With Ignition Key

Four Speed Automatic Transaxle

Your vehicle may be towed under the following conditions: The steering column must be unlocked and the gear selector must be in NEUTRAL, the distance to be towed must not exceed 100 miles (160 km), and the towing speed must not exceed 44 mph (72 km/h). If the transaxle is not operative, or if the vehicle is to be towed

more than 100 miles (160 km), the vehicle must be towed with the front wheels off the ground to avoid damage to the transaxle.

Manual Transaxle

Your vehicle may be towed if the gearshift lever is in NEUTRAL. If the transaxle is not operative, the vehicle must be towed with the front wheels off the ground.

All Transaxles

CAUTION!

If the vehicle being towed requires steering, the ignition switch must be in the ACCESSORY position, not in the LOCK positions.

Do not attempt to use sling type equipment when towing. When securing vehicle to flat bed truck, do not attach to front or rear suspension components. Damage to your vehicle may result from improper towing.

If it is necessary to use the accessories while being towed (wipers, defrosters, etc.), the key must be in the ON position, not the ACCESSORY position. Make certain the transaxle remains in NEUTRAL.

Without The Ignition Key

Special care must be taken when the vehicle is towed with the ignition in the LOCK position. A dolly should be used under the front wheels if the rear wheels are raised. Proper towing equipment is necessary to prevent damage to the vehicle.

Towing This Vehicle Behind Another Vehicle (Flat Towing With All Four Wheels On The Ground)

If your vehicle is equipped with a manual transaxle, it may be towed at any legal highway speed, for any distance, if the transaxle is in neutral.

If the ignition key is not available, vehicles with automatic transaxles can not be flat towed at any time.

CONVERTIBLE TOP MANUAL OVERRIDE

If your vehicle is experiencing electrical failure (low battery, etc.) and it is necessary to raise the convertible top, perform the following steps:

1. Locate the convertible top motor bypass screw, which is found in the trunk under the convertible top storage area.
2. Turn the screw counterclockwise until the screw stops. This will relieve the hydraulic pressure and allow the convertible top to be raised manually.

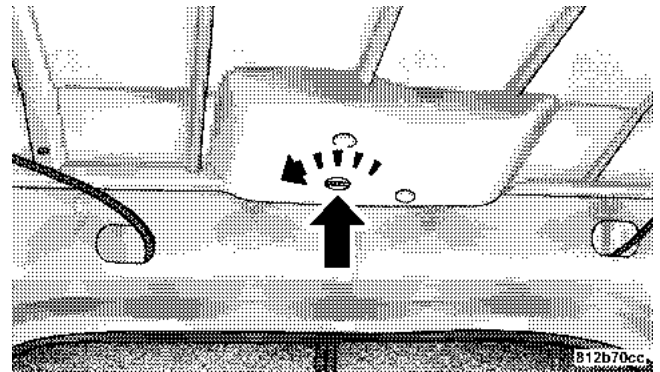

Bleeder Screw

3. Using the latch handle raise the top until the two pins seat themselves in the windshield header.
4. Rotate the latch handle clockwise to open the latches.
5. Pull down and rotate the handle counterclockwise to engage the latches.

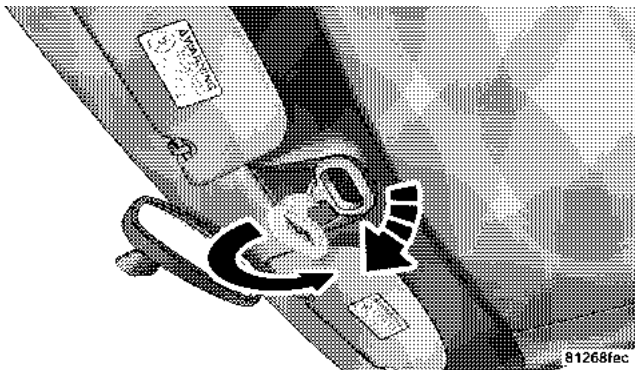

Engaging Convertible Top

6. Raise the handle into the stowed position.
7. Close the convertible top motor bypass screw by turning the screw clockwise until it stops. Tighten the screw securely.

NOTE: Failure to tighten the bypass screw securely can cause convertible top operating concerns.

MAINTAINING YOUR VEHICLE

CONTENTS

■ 2.4L Turbo Engine Compartment362	□ Engine Oil368
■ 2.4L Engine Compartment363	□ Drive Belts — Check Condition And Tension . .	.372
■ Onboard Diagnostic System — OBD II364	□ Spark Plugs372
□ Loose Fuel Filler Cap Message364	□ Ignition Wiring System372
■ Emissions Inspection And Maintenance Programs365	□ Catalytic Converter372
■ Replacement Parts366	□ Engine Timing Belt374
■ Dealer Service367	□ Crankcase Emission Control System374
■ Maintenance Procedures367	□ Fuel Filter374
		□ Air Cleaner Element (Filter)374

360 MAINTAINING YOUR VEHICLE

□ Maintenance-Free Battery	375	□ Manual Transaxle	394
□ Air Conditioner Maintenance	377	□ Appearance Care And Protection From Corrosion	395
□ Power Steering — Fluid Check	378	■ Convertible Top Care	400
□ Front Suspension Ball Joints	378	□ Washing	400
□ Body Lubrication	379	□ General Cleaning	401
□ Windshield Wiper Blades	379	□ Cloth Top Additional Cleaning Procedure	402
□ Windshield Washer Reservoir	380	□ Cloth Top Protection	402
□ Exhaust System	381	□ Weather Strip Care	402
□ Cooling System	382	■ Integrated Power Module (IPM)	403
□ Hoses And Vacuum/Vapor Harnesses	387	■ Vehicle Storage	406
□ Fuel System Connections	387	■ Replacement Bulbs	407
□ Brake System	388	■ Bulb Replacement	408
□ Automatic Transaxle	391		

□ Headlight Bulb Replacement	408	□ Center High Mounted Stop Light	410
□ Front Park/Turn Signal/Side Marker Lights	409	■ Fluids And Capacities	411
□ Front Fog Lights — If Equipped	409	■ Fluids, Lubricants And Genuine Parts	412
□ Tail/Stop, And Rear Turn Signal Lights	410	□ Engine	412
□ Back Up Light Bulb	410	□ Chassis	413

2.4L TURBO ENGINE COMPARTMENT

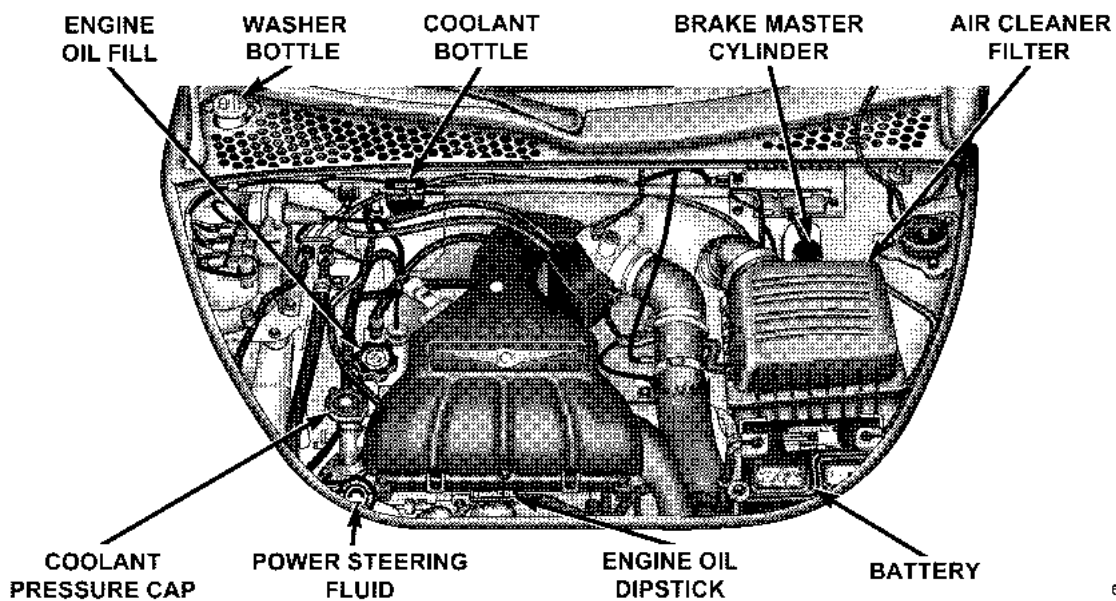

2.4L ENGINE COMPARTMENT

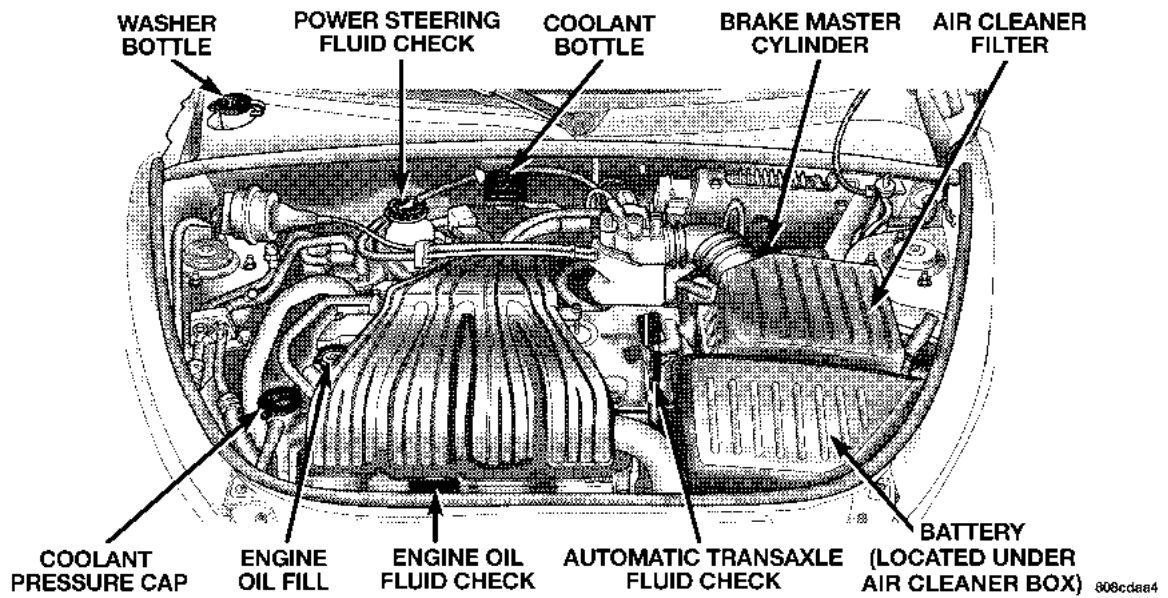

ONBOARD DIAGNOSTIC SYSTEM — OBD II

Your vehicle is equipped with a sophisticated onboard diagnostic system called OBD II. This system monitors the performance of the emissions, engine, and automatic transmission control systems. When these systems are operating properly, your vehicle will provide excellent performance and fuel economy, as well as engine emissions well within current government regulations.

If any of these systems require service, the OBD II system will turn on the “Malfunction Indicator Light.” It will also store diagnostic codes and other information to assist your service technician in making repairs. Although your vehicle will usually be drivable and not need towing, see your dealer for service as soon as possible.

CAUTION!

- **Prolonged driving with the “Malfunction Indicator Light” on could cause further damage to the emission control system. It could also affect fuel economy and driveability. The vehicle must be serviced before any emissions tests can be performed.**
- **If the “Malfunction Indicator Light” is flashing while the engine is running, severe catalytic converter damage and power loss will soon occur. Immediate service is required.**

Loose Fuel Filler Cap Message

After fuel is added, the vehicle diagnostic system can determine if the fuel filler cap is loose, improperly installed, or damaged. A gASCAP message will be displayed in the instrument cluster. Tighten the gas cap until

a "clicking" sound is heard. This is an indication that the gas cap is properly tightened. Press the odometer reset button to turn the message off. If the problem persists, the message will appear the next time the vehicle is started. This might indicate a damaged cap. If the problem is detected twice in a row, the system will turn on the Malfunction Indicator Light (MIL). Resolving the problem will turn the MIL light off.

EMISSIONS INSPECTION AND MAINTENANCE PROGRAMS

In some localities, it may be a legal requirement to pass an inspection of your vehicle's emissions control system. Failure to pass could prevent vehicle registration.



For states which have an I/M (Inspection and Maintenance) requirement, this check verifies the following: the MIL (Malfunction Indicator Lamp)

is functioning and is not on when the engine is running, and that the OBD (On Board Diagnostic) system is ready for testing.

Normally, the OBD system will be ready. The OBD system may **not** be ready if your vehicle was recently serviced, if you recently had a dead battery, or a battery replacement. If the OBD system should be determined not ready for the I/M test, your vehicle may fail the test.

Your vehicle has a simple ignition key actuated test which you can use prior to going to the test station. To check if your vehicle's OBD system is ready, you must do the following:

1. Insert your ignition key into the ignition switch.
2. Turn the ignition to the ON position, but do not crank or start the engine.
3. If you crank or start the engine, you will have to start this test over.

4. As soon as you turn your key to the ON position, you will see your MIL symbol come on as part of a normal bulb check.

5. Approximately 15 seconds later, one of two things will happen:

a. The MIL will flash for about 10 seconds and then return to being fully illuminated until you turn off the ignition key or start the engine. This means that your vehicle's OBD system is **not ready** and you should **not** proceed to the I/M station.

b. The MIL will not flash at all and will remain fully illuminated until you turn off the ignition key or start the engine. This means that your vehicle's OBD system is **ready** and you can proceed to the I/M station.

If your OBD system is **not ready**, you should see your authorized dealer or repair facility. If your vehicle was recently serviced or had a battery failure or replacement,

you may need to do nothing more than drive your vehicle as you normally would in order for your OBD system to update. A recheck with the above test routine may then indicate that the system is now ready.

Regardless of whether your vehicle's OBD system is ready or not ready, if the MIL symbol is illuminated during normal vehicle operation, you should have your vehicle serviced before going to the I/M station. The I/M station can fail your vehicle because the MIL symbol is on with the engine running.

REPLACEMENT PARTS

Use of genuine Mopar® parts for normal/scheduled maintenance and repairs is highly recommended to insure the designed performance. Damage or failures caused by the use of non-Mopar® parts for maintenance and repairs will not be covered by the manufacturer's warranty.

DEALER SERVICE

Your dealer has the qualified service personnel, special tools and equipment to perform all service operations in an expert manner. Service Manuals are available which include detailed service information for your vehicle. Refer to these manuals before attempting any procedure yourself.

NOTE: Intentional tampering with emissions control systems can result in civil penalties being assessed against you.

WARNING!

You can be badly injured working on or around a motor vehicle. Do only that service work for which you have the knowledge and the proper equipment. If you have any doubt about your ability to perform a service job, take your vehicle to a competent mechanic.

MAINTENANCE PROCEDURES

The pages that follow contain the **required** maintenance services determined by the engineers who designed your vehicle.

Besides the maintenance items for which there are fixed maintenance intervals, there are other items that should operate satisfactorily without periodic maintenance. However, if a malfunction of these items does occur, it

could adversely affect the engine or vehicle performance. These items should be inspected if a malfunction is observed or suspected.

Engine Oil

Checking Oil Level

To assure proper engine lubrication, the engine oil must be maintained at the correct level. Check the oil level at regular intervals, such as every fuel stop.

The best time to check the engine oil level is about 5 minutes after a fully warmed engine is shut off or before starting the engine after it has sat overnight.

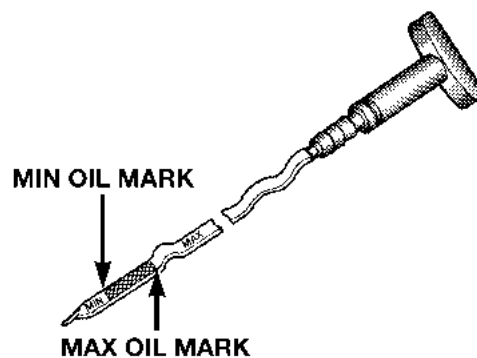

80975a64

Engine Oil Dipstick

Checking the oil while the vehicle is on level ground, will improve the accuracy of the oil level readings. Maintain the oil level between the MIN and MAX markings on the dipstick. Adding one quart of oil when the reading is at the MIN mark will result in a MAX reading on these engines.

CAUTION!

Overfilling the crankcase as indicated by an oil level above the "Max" mark on the engine oil dipstick will cause oil aeration, which can lead to loss of oil pressure and an increase in oil temperature. This could damage your engine.

Change Engine Oil

Road conditions and your kind of driving affects the interval at which your oil should be changed. Check the following list to decide if any apply to you.

- Day and night temperatures are below 32°F (0°C).
- Stop and Go driving.
- Extensive engine idling.
- Driving in dusty conditions.

- Short trips of less than 10 miles (16 km).
- More than 50% of your driving is at sustained high speeds during hot weather, above 90°F (32°C).
- Trailer towing.
- Taxi, Police or delivery service (commercial service).
- Off-Road or desert operation.
- **If equipped for and operating with E-85 (ethanol) fuel.**

NOTE: If ANY of these apply to you then change your engine oil every 3,000 miles (5 000 km) or 3 months, whichever comes first, and follow schedule "B—All Engines" of the "Maintenance Schedules" section of this manual.

If none of these apply to you, and your vehicle is equipped with a Non-Turbo Charged Engine then

change your engine oil at every interval shown on schedule “A”—NON TURBO in the maintenance schedule section of this manual.

If none of these apply to you, and your vehicle is equipped with a Turbo Charged Engine change your engine oil at every interval shown on schedule “A”—TURBO in the maintenance schedule section of this manual.

NOTE: Under no circumstances should oil change intervals exceed 6000 miles (10 000 km) or 6 months whichever comes first.

Engine Oil Selection

For best performance and maximum protection under all types of operating conditions, the manufacturer only recommends engine oils that are API certified and meet the requirements of DaimlerChrysler Material Standard MS-6395.

American Petroleum Institute (API) Engine Oil Identification Symbol



This symbol means that the oil has been certified by the American Petroleum Institute (API). The manufacturer only recommends API Certified engine oils.

Engine Oil Viscosity (SAE Grade)

SAE 5W-30 engine oil is recommended for all operating temperatures. This engine oil improves low temperature starting and vehicle fuel economy. Your engine oil filler cap also shows the recommended engine oil viscosity grade for your engine.

For information on engine oil filler cap location, see the Engine Compartment illustration in this section.

Lubricants which do not have both, the engine oil certification mark and the correct SAE viscosity grade number should not be used.

Synthetic Engine Oils

There are a number of engine oils being promoted as either synthetic or semi-synthetic. If you chose to use such a product, use **only** those oils that are American Petroleum Institute (API) Certified and have the recommended SAE viscosity grade. Follow the maintenance schedule that describes your driving type.

Materials Added To Engine Oils

The manufacture strongly recommends against the addition of any additives (other than leak detection dyes) to the engine oil. Engine oil is an engineered product and it's performance may be impaired by supplemental additives.

Disposing of Used Engine Oil

Care should be taken in disposing of used engine oil from your vehicle. Used oil, indiscriminately discarded, can present a problem to the environment. Contact your dealer, service station, or governmental agency for advice on how and where used oil can be safely discarded in your area.

Engine Oil Filter

The engine oil filter should be replaced at every engine oil change.

Engine Oil Filter Selection

All of this manufacturers engines have a full-flow type disposable oil filter. Use a filter of this type for replacement. The quality of replacement filters varies considerably. Only high quality filters should be used to assure most efficient service. Mopar Engine Oil Filters are high quality oil filters and are recommended.

Drive Belts — Check Condition and Tension

At the mileage shown in the maintenance schedules, check all drive belts for condition and proper tension. Improper belt tension can cause belt slippage and failure.

Inspect the drive belts for evidence of cuts, cracks, or glazing and replace them if there is any sign of damage which could result in belt failure. If adjustment is required, see your authorized dealer for service.

Special tools are required to properly measure tension and to restore belt tension to factory specifications. Also, check belt routing to make sure there is no interference between the belts and other engine components.

Spark Plugs

Spark plugs must fire properly to assure engine performance and emission control. New plugs should be installed at the specified mileage. The entire set should be replaced if there is any malfunction due to a faulty spark

plug. Refer to the Engine data Label located under the hood for the proper type of spark plug for use in your vehicle.

Ignition Wiring System

The ignition cables should be kept clean and properly connected. Terminals should be fully seated. Cracked, damaged, or faulty cables should be replaced.

Catalytic Converter

The catalytic converter requires the use of unleaded fuel only. Leaded gasoline will destroy the effectiveness of the catalyst as an emission control device.

Under normal operating conditions, the catalytic converter will not require maintenance. However, it is important to keep the engine properly tuned to assure proper catalyst operation and prevent possible catalyst damage.

CAUTION!

Damage to the catalytic converter can result if your vehicle is not kept in proper operating condition. In the event of engine malfunction, particularly involving engine misfire or other apparent loss of performance, have your vehicle serviced promptly. Continued operation of your vehicle with a severe malfunction could cause the converter to overheat, resulting in possible damage to the converter and the vehicle.

WARNING!

A hot exhaust system can start a fire if you park over materials that can burn. Such materials might be grass or leaves coming into contact with your exhaust system. Do not park or operate your vehicle in areas where your exhaust system can contact anything that can burn.

In unusual situations involving grossly malfunctioning engine operation, a scorching odor may suggest severe and abnormal catalyst overheating. If this occurs, stop the vehicle, turn off the engine and allow it to cool. Service, including a tune up to manufacturers specifications, should be obtained immediately.

To minimize the possibility of catalyst damage:

- Do not shut off the engine or interrupt the ignition when the transaxle is in gear and the vehicle is in motion.
- Do not try to start the engine by pushing or towing the vehicle.
- Do not idle the engine with any spark plug wires disconnected for prolonged period.

Engine Timing Belt

Replace the engine timing belt at the intervals described in the appropriate maintenance schedule.

Crankcase Emission Control System

Proper operation of this system depends on freedom from sticking or plugging due to deposits. As vehicle mileage builds up, the PCV valve and passages may accumulate deposits. If a valve is not working properly, replace it with a new valve. **DO NOT ATTEMPT TO CLEAN THE OLD PCV VALVE!**

Check ventilation hose for indication of damage or plugging deposits. Replace if necessary.

Fuel Filter

A plugged fuel filter can cause hard starting or limit the speed at which a vehicle can be driven. Should an excessive amount of dirt accumulate in the fuel tank, frequent filter replacement may be necessary. The fuel filters are located inside the fuel tank. See your dealer for service.

Air Cleaner Element (Filter)

Under normal driving conditions, replace the filter at the intervals shown on Schedule "A". If, however, you drive the vehicle frequently under dusty or severe conditions, the filter element should be inspected periodically and replaced if necessary at the intervals shown on Schedule "B".

NOTE: For vehicles with a Turbo engine, a small amount of oil accumulation in the air cleaner box is

normal. The amount will depend on driving style. The air cleaner box should be cleaned out and a new make-up-air filter element should be installed during the normal air filter maintenance procedure.

WARNING!

The air cleaner can provide a measure of protection in the case of engine backfire. Do not remove the air cleaner unless such removal is necessary for repair or maintenance. Make sure that no one is near the engine compartment before starting the vehicle with the air cleaner removed. Failure to do so can result in serious personal injury.

Maintenance-Free Battery

You will never have to add water, nor is periodic maintenance required.

CAUTION!

When servicing the battery, always reinstall the battery thermowrap. The thermowrap provides battery heat protection and will extend overall battery life. Failure to reinstall the thermowrap can result in evaporative loss of the battery fluid.

WARNING!

Battery fluid is a corrosive acid solution and can burn or even blind you. Don't allow battery fluid to contact your eyes, skin or clothing. Don't lean over a battery when attaching clamps. If acid splashes in eyes or on skin, flush the area immediately with large amounts of water.

Battery gas is flammable and explosive. Keep flame or sparks away from the battery. Don't use a booster battery or any other booster source with an output greater than 12 volts. Don't allow cable clamps to touch each other.

Battery posts, terminals and related accessories contain lead and lead compounds. Wash hands after handling.

CAUTION!

It is essential when replacing the cables on the battery that the positive cable is attached to the positive post and the negative cable is attached to the negative post. Battery posts are marked positive (+) and negative (-) and identified on the battery case. Cable clamps should be tight on the terminal posts and free of corrosion. Apply grease to posts and clamps after tightening.

If a "fast charger" is used while the battery is in the vehicle, disconnect both vehicle battery cables before connecting the charger to battery. Do not use a "fast charger" to provide starting voltage as battery damage can result.

Air Conditioner Maintenance

For best possible performance, your air conditioner should be checked and serviced by an Authorized Dealer at the start of each warm season. This service should include cleaning of the condenser fins and a performance test. Drive belt tension should also be checked at this time.

WARNING!

- Use only refrigerants and compressor lubricants approved by the manufacturer for your air conditioning system. Some unapproved refrigerants are flammable and can explode, injuring you. Other unapproved refrigerants or lubricants can cause the system to fail, requiring costly repairs. Refer to Section 3 of the Warranty Information book for further warranty information.
- The air conditioning system contains refrigerant under high pressure. To avoid risk of personal injury or damage to the system, adding refrigerant or any repair requiring lines to be disconnected should be done by an experienced repairman.

Refrigerant Recovery and Recycling

R-134a Air Conditioning Refrigerant is a hydrofluorocarbon (HFC) that is endorsed by the Environmental Protection Agency and is an ozone-saving product. However, the manufacturer recommends that air conditioning service be performed by dealers or other service facilities using recovery and recycling equipment.

NOTE: Use only manufacturer approved A/C System Sealers, Stop Leak Products, Seal Conditioners, Compressor Oil, or Refrigerants.

Power Steering — Fluid Check

Checking the power steering fluid level at a defined service interval is not required. The fluid should only be checked if a leak is suspected, abnormal noises are apparent, and/or the system is not functioning as anticipated. Coordinate inspection efforts through a certified DaimlerChrysler Dealership.

WARNING!

Fluid level should be checked on a level surface and with the engine off to prevent injury from moving parts and to insure accurate fluid level reading. Do not overfill. Use only manufacturers recommended power steering fluid.

If necessary, add fluid to restore to the proper indicated level. With a clean cloth, wipe any spilled fluid from all surfaces. Refer to Fluids, Lubricants, and Genuine Parts for correct fluid types.

Front Suspension Ball Joints

There are two front suspension lower ball joints that are permanently lubricated. Inspect these ball joints whenever under vehicle service is done. Damaged seals and their corresponding potentially damaged ball joints must be replaced.

Body Lubrication

Locks and all body pivot points, including such items as seat tracks, doors, liftgate and hood hinges, should be lubricated periodically to assure quiet, easy operation and to protect against rust and wear. Prior to the application of any lubricant, the parts concerned should be wiped clean to remove dust and grit; after lubricating excess oil and grease should be removed. Particular attention should also be given to hood latching components to insure proper function. When performing other underhood services, the hood latch, release mechanism and safety catch should be cleaned and lubricated.

The external lock cylinders should be lubricated twice a year, preferably in the fall and spring. Apply a small amount of a high quality lubricant such as Mopar® Lock Cylinder Lubricant directly into the lock cylinder.

Windshield Wiper Blades

Clean the rubber edges of the wiper blades and the windshield periodically with a sponge or soft cloth and a mild non abrasive cleaner or use the washer solvent. This will remove accumulations of salt, waxes or road film and help reduce streaking and smearing.

Operation of the wipers on dry glass for long periods may cause deterioration of the wiper blades. Always use washer fluid when using the wipers to remove salt or dirt from a dry windshield. Avoid using the wiper blades to remove frost or ice from the windshield. Make sure that they are not frozen to the glass before turning them on to avoid damaging the blade. Keep the blade rubber out of contact with petroleum products such as engine oil, gasoline, etc.

Windshield Wiper Blade Replacement

1. Lift the wiper arm away from the glass.

2. Push the release tab shown in the illustration and slide the wiper blade assembly down along the arm. Gently place the wiper arm on the windshield.
3. Install the new blade assembly onto the wiper arm tip until it locks in place.

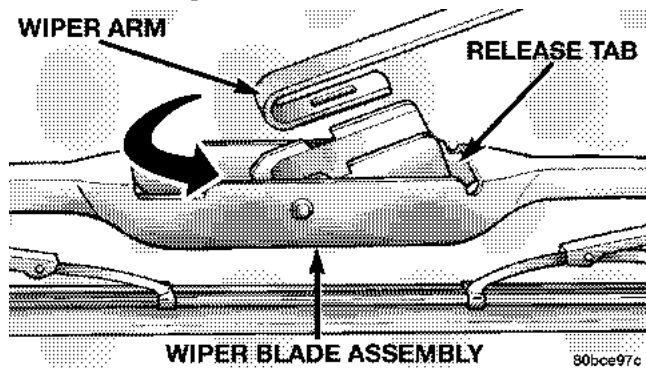

Windshield Washer Reservoir

The washer fluid reservoir is located in the rear of the engine compartment on the passenger side and should be checked for fluid level at regular intervals. Fill the reservoir with windshield washer solvent (not radiator antifreeze).

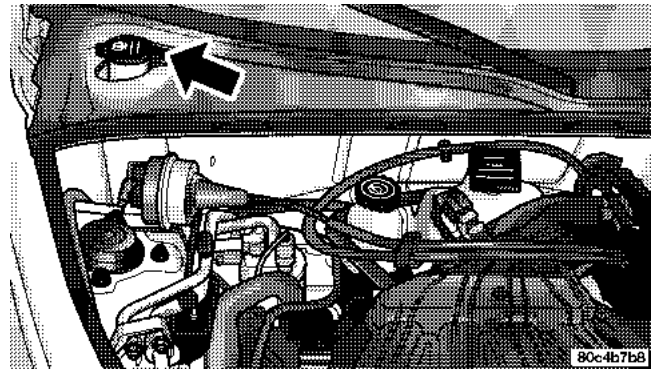

Washer Fluid Reservoir

Exhaust System

The best protection against carbon monoxide entry into the vehicle body is a properly maintained engine exhaust system.

If you notice a change in the sound of the exhaust system, or if exhaust fumes can be detected inside the vehicle, or when the underside or rear of the vehicle is damaged; have a competent technician inspect the complete exhaust system and adjacent body areas for broken, damaged, deteriorated, or mispositioned parts. Open seams or loose connections could permit exhaust fumes to seep into the passenger compartment. In addition, inspect the exhaust system each time the vehicle is raised for an oil change or lubrication. Replace as required.

WARNING!

Exhaust gases can injure or kill. They contain carbon monoxide (CO) which is colorless and odorless. Breathing it can make you unconscious and can eventually poison you. To avoid breathing CO, refer to Exhaust Gas in the Safety Tips section of this manual.

Cooling System

WARNING!

- When working near the radiator cooling fan, disconnect the fan motor lead or turn the ignition switch to the OFF position. The fan is temperature controlled and can start at any time the ignition switch is in the ON position.
- You or others can be badly burned by hot coolant or steam from your radiator. If you see or hear steam coming from under the hood, don't open the hood until the radiator has had time to cool. Never try to open a cooling system pressure cap when the radiator is hot.

Coolant Checks

Check engine coolant (antifreeze) protection every 12 months (before the onset of freezing weather, where applicable). If coolant is dirty or rusty in appearance, the system should be drained, flushed and refilled with fresh coolant. Check the front of the A/C condenser for any accumulation of bugs, leaves, etc. If dirty, clean by gently spraying water from a garden hose vertically down the face of the condenser.

Check the coolant recovery bottle tubing for brittle rubber, cracking, tears, cuts and tightness of the connection at the bottle and radiator. Inspect the entire system for leaks.

Cooling System — Drain, Flush and Refill

At the intervals shown on the Maintenance Schedules, the system should be drained, flushed and refilled.

If the solution is dirty or contains a considerable amount of sediment, clean and flush with a reliable cooling system cleaner. Follow with a thorough rinsing to remove all deposits and chemicals. Properly dispose of old antifreeze solution.

Selection Of Coolant

Use only the manufacturers recommended coolant, refer to Fluids, Lubricants and Genuine Parts for correct coolant type.

CAUTION!

Mixing of coolants other than specified HOAT engine coolants, may result in engine damage and may decrease corrosion protection. If a non-HOAT coolant is introduced into the cooling system in an emergency, it should be replaced with the specified coolant as soon as possible.

Do not use plain water alone or alcohol base engine coolant (antifreeze) products. Do not use additional rust inhibitors or antirust products, as they may not be compatible with the radiator engine coolant and may plug the radiator.

This vehicle has not been designed for use with Propylene Glycol based coolants. Use of Propylene Glycol based coolants is not recommended.

Adding Coolant

Your vehicle has been built with an improved engine coolant that allows extended maintenance intervals. This coolant can be used up to 5 Years or 100,000 miles before replacement. To prevent reducing this extended maintenance period, it is important that you use the same coolant throughout the life of your vehicle. Please review these recommendations for using Hybrid Organic Additive Technology (HOAT) coolant.

When adding coolant, a minimum solution of 50% recommended Mopar Antifreeze/ Coolant 5 Year/100,000 Mile Formula HOAT (Hybrid Organic Additive Technology), or equivalent, in water should be used. Use higher concentrations (not to exceed 70%) if temperatures below -34°F (-37°C) are anticipated.

Use only high purity water such as distilled or deionized water when mixing the water/engine coolant solution.

The use of lower quality water will reduce the amount of corrosion protection in the engine cooling system.

Please note that it is the owner's responsibility to maintain the proper level of protection against freezing according to the temperatures occurring in the area where the vehicle is operated.

NOTE: Mixing coolant types will decrease the life of the engine coolant and will require more frequent coolant changes.

Cooling System Pressure Cap

The cap must be fully tightened to prevent loss of coolant, and to insure that coolant will return to the radiator from the coolant recovery bottle.

The cap should be inspected and cleaned if there is any accumulation of foreign material on the sealing surfaces.

WARNING!

- The warning words “DO NOT OPEN HOT” on the cooling system pressure cap are a safety precaution. Never add coolant when the engine is overheated. Do not loosen or remove the cap to cool an overheated engine. Heat causes pressure to build up in the cooling system. To prevent scalding or injury, do not remove the pressure cap while the system is hot or under pressure.
- Do not use a pressure cap other than the one specified for your vehicle. Personal injury or engine damage may result.

Disposal of Used Engine Coolant

Used ethylene glycol based engine coolant is a regulated substance requiring proper disposal. Check with your local authorities to determine the disposal rules for your community. To prevent ingestion by animals or children

do not store ethylene glycol based engine coolant in open containers or allow it to remain in puddles on the ground. If ingested by a child, contact a physician immediately. Clean up any ground spills immediately.

Coolant Level

The coolant bottle provides a quick visual method for determining that the coolant level is adequate. With the engine idling, and warm to normal operating temperature, the level of the coolant in the bottle should be between the ranges indicated on the bottle.

The radiator normally remains completely full, so there is no need to remove the radiator cap unless checking for coolant freeze point or replacing coolant. Advise your service attendant of this. As long as the engine operating temperature is satisfactory, the coolant bottle need only be checked once a month.

When additional coolant is needed to maintain the proper level, it should be added to the coolant bottle. Do not overfill.

Points To Remember

NOTE: When the vehicle is stopped after a few miles (a few kilometers) of operation, you may observe vapor coming from the front of the engine compartment. This is normally a result of moisture from rain, snow, or high humidity accumulating on the radiator and being vaporized when the thermostat opens, allowing hot coolant to enter the radiator.

If an examination of your engine compartment shows no evidence of radiator or hose leaks, the vehicle may be safely driven. The vapor will soon dissipate.

- Do not overfill the coolant recovery bottle.
- Check coolant freeze point in the radiator and in the coolant recovery bottle. If antifreeze needs to be added, contents of coolant recovery bottle must also be protected against freezing.
- If frequent coolant additions are required, or if the level in the coolant recovery bottle does not drop when the engine cools, the cooling system should be pressure tested for leaks.
- Maintain coolant concentration at 50% HOAT engine coolant (minimum) and distilled water for proper corrosion protection of your engine which contains aluminum components.
- Make sure that the radiator and coolant recovery bottle overflow hoses are not kinked or obstructed.
- Keep the front of the radiator clean. If your vehicle is equipped with air conditioning, keep the front of the condenser clean, also.

- Do not change the thermostat for summer or winter operation. If replacement is ever necessary, install **ONLY** the correct type thermostat. Other designs may result in unsatisfactory coolant performance, poor gas mileage, and increased emissions.

Hoses And Vacuum/Vapor Harnesses

Inspect surfaces of hoses and nylon tubing for evidence of heat and mechanical damage. Hard or soft spots, brittle rubber, cracking, tears, cuts, abrasions, and excessive swelling indicate deterioration of the rubber

Pay particular attention to the hoses nearest to high heat sources such as the exhaust manifold. Inspect hose routing to be sure hoses do not touch any heat source or moving component that may cause heat damage or mechanical wear.

Insure nylon tubing in these areas has not melted or collapsed

Inspect all hose connections such as clamps and couplings to make sure they are secure and no leaks are present.

Components should be replaced immediately if there is any evidence of degradation that could cause failure.

Fuel System Connections

Electronic Fuel Injection high pressure fuel systems are designed with tubes and special connects, connections and clamps which have unique material characteristics to provide adequate sealing and resist attack by deteriorated gasoline.

You are urged to use only the manufactures-specified tubes, connections and clamps, or their equivalent in material and specification, in any fuel system servicing.

Brake System

In order to assure brake system performance, all brake system components should be inspected periodically. Suggested service intervals can be found in the Maintenance Section.

WARNING!

Riding the brakes can lead to brake failure and possibly an accident. Driving with your foot resting or riding on the brake pedal can result in abnormally high brake temperatures, excessive lining wear, and possible brake damage. You wouldn't have your full braking capacity in an emergency.

Brake And Power Steering System Hoses

When servicing the vehicle for scheduled maintenance, inspect the surface of the hoses and nylon tubing for evidence of heat and mechanical damage. Hard and

brittle rubber, cracking, tears, cuts, abrasions, and excessive swelling suggest deterioration of the rubber. Particular attention should be made to examining those hose surfaces nearest to high heat sources, such as the exhaust manifold.

Inspect all hose clamps and couplings to make sure they are secure and no leaks are present.

Insure nylon tubing in these areas has not melted or collapsed.

NOTE: Often, fluids such as oil, power steering fluid, and brake fluid are used during assembly plant operations to ease the assembly of hoses to couplings. Therefore, oil wetness at the hose-coupling area is not necessarily an indication of leakage. Actual dripping of hot fluid when systems are under pressure (during vehicle operation) should be noted before a hose is replaced based on leakage.

NOTE: Inspection of brake hoses should be done whenever the brake system is serviced and at every engine oil change.

WARNING!

Worn brake hoses can burst and cause brake failure. You could have an accident. If you see any signs of cracking, scuffing, or worn spots, have the brake hoses replaced immediately.

Brake Master Cylinder

The fluid level in the master cylinder should be checked when performing under hood services, or immediately if the brake system warning lamp is on.

Be sure to clean the top of the master cylinder area before removing the cap. If necessary, add fluid to bring the fluid level up to the requirements described on the brake

fluid reservoir. Fluid level can be expected to fall as the brake pads wear. Brake fluid level should be checked when pads are replaced. However, low fluid level may be caused by a leak and a checkup may be needed.

NOTE: If your vehicle is equipped with a **manual transaxle**, the Brake Fluid Reservoir supplies fluid to both the Brake System and the Clutch Release System. The two systems are separated in the reservoir and a leak in one system will not affect the other system. The **Manual Transaxle** Clutch Release System should not require fluid replacement during the life of the vehicle. If the Brake Fluid Reservoir is low, and the brake system does not indicate any leaks or other problems, it may be a result of a leak in the Hydraulic Clutch Release System. See your local authorized dealer for service.

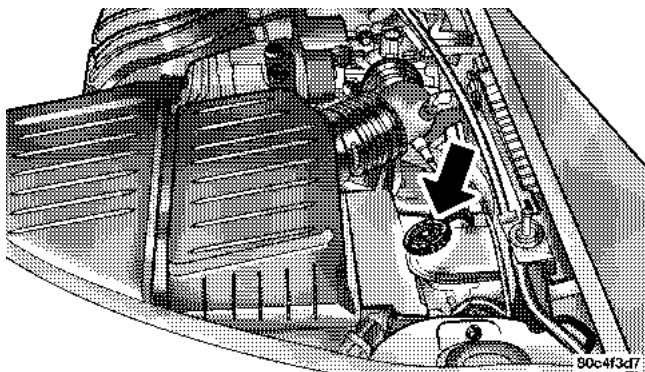

Brake Fluid Master Cylinder

Use only manufacturers recommended brake fluid, refer to Fluids, Lubricants and Genuine Parts for correct fluid type.

WARNING!

Use of a brake fluid that may have a lower initial boiling point or unidentified as to specification, may result in sudden brake failure during hard prolonged braking. You could have an accident.

CAUTION!

Use of improper brake fluids will affect overall clutch system performance. Improper brake fluids may damage the clutch system resulting in loss of clutch function and the ability to shift the transaxle.

WARNING!

Overfilling the brake fluid reservoir can result in spilling brake fluid on hot engine parts and the brake fluid catching fire.

Use only brake fluid that has been in a tightly closed container to avoid contamination from foreign matter.

Do not allow petroleum based fluid to contaminate the brake fluid as seal damage will result!

Automatic Transaxle

All front wheel drive vehicles have a transmission and differential assembly contained within a single housing.

Selection Of Lubricant

It is important that the proper lubricant is used in the transaxle to assure optimum transaxle performance. Use only manufacturers recommended transmission fluid,

refer to Fluids, Lubricants and Genuine Parts for correct fluid type. It is important that the transmission fluid be maintained at the prescribed level using the recommended fluid.

CAUTION!

Using a transmission fluid other than the manufacturers recommended fluid may cause deterioration in transmission shift quality and/or torque converter shudder. Using a transmission fluid other than the manufacturers recommended fluid will result in more frequent fluid and filter changes. Refer to Fluids, Lubricants and Genuine Parts for correct fluid type.

Fluid Level Check

The fluid level in the automatic transaxle should be checked whenever the vehicle is serviced. Operation with an improper fluid level will greatly reduce the life of the transaxle and of the fluid.

Procedure For Checking Fluid Level

To properly check the automatic transaxle fluid level, the following procedure must be used:

1. The vehicle must be on level ground.
2. The engine should be running at curb idle speed for at minimum of 60 seconds.
3. Fully apply parking brake.
4. Depress the brake pedal and place the gear selector momentarily in each gear position ending with the lever in P (PARK).
5. Remove the dipstick and determine if the fluid is hot or warm. Hot fluid is approximately 180°F (82°C), which is the normal operating temperature after the vehicle has been driven at least 24 km (15 miles). The fluid cannot be comfortable held between the finger tips. Warm is when the fluid is between 85° to 125°F (29° to 52°C).

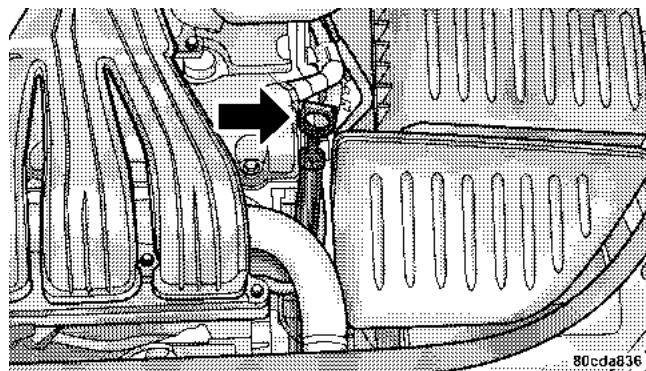

Transaxle Dipstick Location

6. Wipe the dipstick clean and reinsert until seated. Remove dipstick and note reading.

If the fluid is hot, reading should be in the cross hatched area marked "HOT" between the upper two holes in the dipstick.

If the fluid is cold, the fluid level should be between the lower two holes, into the area marked "LOW".

If the fluid level shows low, add sufficient transmission fluid to bring to the proper level.

CAUTION!

Do not overfill. Dirt and water in the transaxle can cause serious damage. To prevent dirt and water from entering the transaxle after checking or replenishing fluid, make certain that the dipstick cap is seated properly.

Fluid And Filter Changes

Automatic transmission fluid and filter should be changed as follows:

Maintenance schedule "A"—Non Turbo Charged Engines – No change necessary.

Maintenance schedule "A"—Turbo Charged Engines – No change necessary.

Maintenance schedule "B"—All Engines – Every 60,000 miles (100 000 km) change fluid and filter under the following conditions:

- Police, taxi, limousine, commercial type operation, or trailer towing where the vehicle is driven **regularly** for more than 45 minutes of continuous operation.

NOTE: Refer to Section 8 of this manual for maintenance schedules.

If the transaxle is disassembled for any reason, the fluid and filter should be changed.

Special Additives

The manufacturer recommends against the addition of any fluid additives to the transaxle. The only exception to this policy is the use of special dyes to aid in detecting fluid leaks. The use of transmission sealers should be avoided as they may adversely affect seals.

Manual Transaxle

Lubricant Selection

Use only manufacturers recommended transmission fluid, refer to Fluids, Lubricants and Genuine Parts for correct fluid type.

Fluid Level Check

Check the fluid level by removing the fill plug. The fluid level should be between the bottom of the fill hole and a point not more than 3/16" (4.7 mm) below the bottom of the hole.

Add fluid, if necessary, to maintain the proper level.

Frequency Of Fluid Change

Under normal operating conditions, the fluid installed at the factory will give satisfactory lubrication for the life of the vehicle. Fluid changes are not necessary unless the following conditions exist:

- The lubricant has become contaminated with water. If contaminated with water, the fluid should be changed immediately.
- If severe usage has occurred, refer to Maintenance Schedule "B" in Section 8 of this manual.

Appearance Care And Protection From Corrosion

Protection Of Body And Paint from Corrosion

Vehicle body care requirements vary according to geographic locations and usage. Chemicals that make roads passable in snow and ice, and those that are sprayed on trees and road surfaces during other seasons, are highly corrosive to the metal in your vehicle. Outside parking, which exposes your vehicle to airborne contaminants, road surfaces on which the vehicle is operated, extreme hot or cold weather and other extreme conditions will have an adverse effect on paint, metal trim, and underbody protection.

The following maintenance recommendations will enable you to obtain maximum benefit from the corrosion resistance built into your vehicle.

What Causes Corrosion?

Corrosion is the result of deterioration or removal of paint and protective coatings from your vehicle.

The most common causes are:

- Road salt, dirt and moisture accumulation.
- Stone and gravel impact.
- Insects, tree sap and tar.
- Salt in the air near sea coast localities.
- Atmospheric fallout/industrial pollutants.

Washing

- Wash your vehicle regularly. Always wash your vehicle in the shade using Mopar Car Wash or a mild car wash soap, and rinse the panels completely with clear water.
- If insects, tar or other similar deposits have accumulated on your vehicle, use Mopar Super Kleen Bug and Tar Remover to remove.

- Use Mopar Cleaner Wax to remove road film, stains and to protect your paint finish. Take care never to scratch the paint.
- Avoid using abrasive compounds and power buffing that may diminish the gloss or thin out the paint finish.

CAUTION!

Do not use abrasive or strong cleaning materials such as steel wool or scouring powder, which will scratch metal and painted surfaces.

Special Care

- If you drive on salted or dusty roads or if you drive near the ocean, hose off the undercarriage at least once a month.
- It is important that the drain holes in the lower edges of the doors, rocker panels and trunk be kept clear and open.
- If you detect any stone chips or scratches in the paint, touch them up immediately. The cost of such repairs is considered the responsibility of the owner.
- If your vehicle is damaged due to an accident or similar cause which destroys the paint and protective coating, have your vehicle repaired as soon as possible. The cost of such repairs is considered the responsibility of the owner.
- All wheels and wheel trim, especially aluminum and chrome plated wheels should be cleaned regularly with a mild soap and water to prevent corrosion. To remove heavy soil, use Mopar Wheel Cleaner or select a nonabrasive, non-acidic cleaner. Do not use scouring pads, steel wool, a bristle brush or metal polishes. Only Mopar cleaners are recommended. Do not use

oven cleaner. Avoid automatic car washes that use acidic solutions or harsh brushes that may damage the wheels' protective finish.

- If you carry special cargo such as chemicals, fertilizers, de-icer salt, etc., be sure that such materials are well packaged and sealed.
- If a lot of driving is done on gravel roads, consider mud or stone shields behind each wheel.
- Use Mopar touch up paint on scratches as soon as possible. Your dealer has touch up paint to match the color of your vehicle.

Wheel And Wheel Trim Care

All wheels and wheel trim, especially Aluminum and Chrome plated, should be cleaned regularly, when cool, using mild soap and water to maintain their luster and to

prevent corrosion. Wash them with the same soap solution as the body of your vehicle. Rinse wheels thoroughly.

When cleaning extremely dirty wheels, care must be taken in the selection of tire and wheel cleaning chemicals and equipment to prevent damage to the wheels. Only Mopar Wheel Cleaners are recommended. DO NOT USE any of the items listed below which can damage your wheels and wheel trim.

DO NOT USE:

- Any abrasive cleaner
- Any abrasive cleaning pad (such as steel wool) or abrasive brush
- Any cleaner that contains an acid which can react with and discolor the chrome surface.
- Chrome polish

- Oven cleaner
- A car wash that uses carbide-tipped wheel cleaning brushes or acidic solutions.

CAUTION!

Many wheel cleaners contain acids that may harm the wheel surface.

NOTE: Replacement costs for components damaged as a result of not following the recommended cleaning practices are considered the responsibility of the customer.

Interior Care

Use Mopar Total Clean to clean fabric upholstery and carpeting.

Use Mopar Total Clean to clean vinyl upholstery.

Mopar Total Clean is specifically recommended for leather upholstery.

Your leather upholstery can be best preserved by regular cleaning with a damp soft cloth. Small particles of dirt can act as an abrasive and damage the leather upholstery and should be removed promptly with a damp cloth. Stubborn soils can be removed easily with a soft cloth and Mopar Total Clean. Care should be taken to avoid soaking your leather upholstery with any liquid. Please do not use polishes, oils, cleaning fluids, solvents, detergents, or ammonia based cleaners to clean your leather upholstery. Application of a leather conditioner is not required to maintain the original condition.

WARNING!

Do not use volatile solvents for cleaning purposes. Many are potentially flammable, and if used in closed areas they may cause respiratory harm.

Cleaning Headlights

Your vehicle has plastic headlights that are lighter and less susceptible to stone breakage than glass headlights.

Plastic is not as scratch resistant as glass and therefore different lens cleaning procedures must be followed.

To minimize the possibility of scratching the lenses and reducing light output, avoid wiping with a dry cloth. To remove road dirt, wash with a mild soap solution followed by rinsing.

Do not use abrasive cleaning components, solvents, steel wool or other aggressive material to clean the lenses.

Glass Surfaces

All glass surfaces should be cleaned on a regular basis with Mopar Glass Cleaner or any commercial household-type glass cleaner. Never use an abrasive type cleaner. Use caution when cleaning the inside rear window equipped with electric defrosters or the right rear quarter window equipped with the radio antenna. Do not use scrapers or other sharp instruments which may scratch the elements. When cleaning the rear view mirror, spray cleaner on the towel or rag that you are using. Do not spray cleaner directly on the mirror.

Instrument Panel Cover

The instrument panel cover has a low glare surface which minimizes reflections in the windshield. Do not use protectants or other products which may cause undesirable reflections. Use soap and warm water to restore the low glare surface.

Cleaning Plastic Instrument Cluster Lenses

The lenses in front of the instruments in this vehicle are molded in clear plastic. When cleaning the lenses, care must be taken to avoid scratching the plastic.

1. Clean with a wet soft rag. A mild soap solution may be used, but do not use high alcohol content or abrasive cleaners. If soap is used, wipe clean with a clean damp rag.
2. Dry with a soft tissue.

Seat Belt Maintenance

Do not bleach, dye or clean the belts with chemical solvents or abrasive cleaners. This will weaken the fabric. Sun damage can also weaken the fabric.

If the belts need cleaning, use a mild soap solution or lukewarm water. Do not remove the belts from the car to wash them.

Replace the belts if they appear frayed or worn or if the buckles do not work properly.

Dry with a soft tissue.

CONVERTIBLE TOP CARE

Immediate removal of any contaminant is recommended. Regular washing of the top will enhance its life and appearance, and make successive cleanings easier. Do not subject the top to excessive heat. Frequently vacuum the top and storage compartment.

Washing

Hand washing is highly recommended. Automatic car washing equipment can damage the top material. If you must use an automatic car wash, soft cloth systems are preferred.

CAUTION!

Avoid high pressure car washes, as they can damage the top material. Also, increased water pressure may force water past the weather strips.

General Cleaning

Careful vacuuming of the top before washing is helpful in removing dust and other foreign particles. Wash in partial shade instead of direct sun. Wet the entire vehicle before washing the top. The top should be washed with a soft, natural bristle scrub brush, and Mopar Car Wash or a mild soap solution. Do not use detergent.

CAUTION!

Never use an abrasive type cleaner or bleaches. Cleaners should not contain silicones, organic solvents, petroleum distillates or plasticizers. always wait until the top is thoroughly dry before lowering it into the storage area.

Scrub in all directions, covering an area of about two square feet at a time. Avoid heavy scrubbing. Rinse the entire vehicle with water to remove all soap and dirt from the top fabric and to prevent streaking on painted and chrome surfaces. Allow the top to dry before lowering. Vacuuming the top with a wet/dry shop vacuum will decrease the top's drying time, ensure removal of all dirt, and delete streaks in the material. Multiple cleanings may be necessary to remove stubborn stains. If stains persist, contact your local dealership for further suggestions.

Cloth Top Additional Cleaning Procedure

For additional cleaning assistance in removing stubborn stains, apply Mopar Convertible Cloth Top Cleaner (part number 05012245AA) to the complete stain, extending 2 inches (50 mm) beyond the stain. With a soft bristle brush, scrub in all directions over the stain. Avoid heavy scrubbing. Rinse the area with warm water. If the stain is still apparent, repeat the cleaning procedure. When the stain is no longer showing, rinse the complete top with warm water. Let the top dry before lowering it. 7

Cloth Top Protection

For appearance purposes, you may wish to protect your Twillfast™ (cloth) top periodically. Use Mopar Convertible Cloth Top Treatment or a fabric protectant such as Scotchguard_ is suggested. The top should be clean and dry before application of the protectant.

CAUTION!

Avoid getting Scotchguard_ on the surrounding weather strips, moldings, paint, or glass. Damage to these items might occur.

Weather Strip Care

Lubricate all top and door glass weather strips periodically with Mopar Weather Strip Lubricant (part number 4773427), to keep them soft and pliable.

INTEGRATED POWER MODULE (IPM)

An Integrated Power Module is located in the engine compartment near the air cleaner assembly. This center contains cartridge fuses and mini fuses. A description of each fuse and component may be stamped on the inside of the cover.

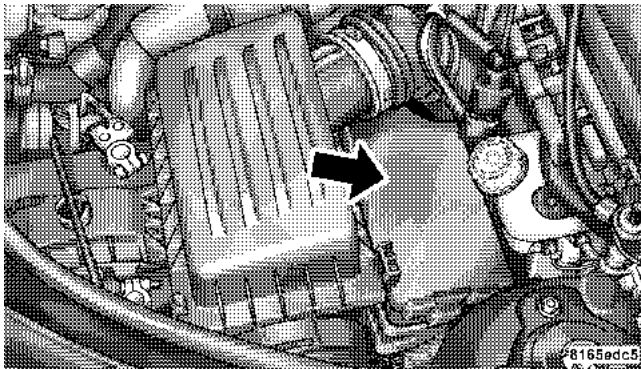

Integrated Power Module Location

Cavity	Cartridge Fuse	Mini Fuse	Description
1	40 Amp Green		Power Top Feed
2		20 Amp Yellow	AWD ECU Feed
3		10 Amp Red	CHMSL Brake Switch Feed
4		10 Amp Red	Ignition Switch Feed
5		20 Amp Yellow	Trailer Tow
6		10 Amp Red	IOD Sw/Pwr Mir/Ocm Steering Cntrl Sdar/Hfm
7		30 Amp Green	IOD Sense1
8		30 Amp Green	IOD Sense2
9	40 Amp Green		Power Seats

404 MAINTAINING YOUR VEHICLE

Cavity	Cartridge Fuse	Mini Fuse	Description
10		20 Amp Yellow	CCN, Power Locks
11		15 Amp Lt Blue	Power Outlet
12		20 Amp Yellow	Ign Run/Acc Inverter
13		20 Amp Yellow	Pwr run/Acc Outlet RR
14		10 Amp Red	IOD CCN/ Interior Lighting
15	50 Amp Red		RAD Fan Relay Battery Feed
16		15 Amp Lt. Blue	IGN Run/Acc Cigar Ltr/Sunroof
17		10 Amp Red	IOD Feed CVT Mod/Mod_Wcm

Cavity	Cartridge Fuse	Mini Fuse	Description
18	40 Amp Green		ASD Relay Contact PWR Feed
19		20 Amp Yellow	PWR Amp 1 & Amp 2 Feed
20		15 Amp Lt. Blue	IOD Feed Radio
21		10 Amp Red	IOD Feed Intrus Mod/Siren
22		10 Amp Red	IGN RUN Hvac/Compass Sensor
23		15 Amp Lt. Blue	ENG ASD Relay Feed 3
24		25 Amp Natural	PWR Sunroof Feed
25		10 Amp Red	Heated Mirror

Cavity	Cartridge Fuse	Mini Fuse	Description
26		15 Amp Lt. Blue	ENG ASD Relay Feed 2
27		10 Amp Red	IGN RUN Only ORC Feed
28		10 Amp Red	IGN RUN ORC/OCM Feed
29			EMPTY
30		20 Amp Yellow	Heated Seats
31		10 Amp Red	Headlamp Washer Relay Control
32	30 Amp Pink		ENG ASD Control Feed 1

Cavity	Cartridge Fuse	Mini Fuse	Description
33		10 Amp Red	ABS MOD/J1962 Conn/PCM
34	30 Amp Pink		ABS Valve Feed
35	40 Amp Green		ABS Pump Feed
36	30 Amp Pink		Headlamp Washer Control
37		25 Amp Natural	Spare

CAUTION!

- When installing the Integrated Power Module cover, it is important to ensure the cover is properly positioned and fully latched. Failure to do so may allow water to get into the Integrated Power Module, and possibly result in a electrical system failure.
- When replacing a blown fuse, it is important to use only a fuse having the correct amperage rating. The use of a fuse with a rating other than indicated may result in a dangerous electrical system overload. If a properly rated fuse continues to blow, it indicates a problem in the circuit that must be corrected.

VEHICLE STORAGE

If you will not be using your vehicle for more than 21 days you may want to take steps to preserve your battery. You may:

- Disengage the mini fuse in the Power Distribution Center labeled IOD (Ignition Off-Draw).
- Or, disconnect the negative cable from the battery.

REPLACEMENT BULBS

LIGHT BULBS — Inside	Bulb No.
Center Console Floor Lamp	T37
Climate Controls	6233137
Console Gear Selector	PC194
Dome Light (sedan)	T579
Dome Light / Sport Bar Lights (convertible)	T904
Instrument Cluster Illumination	74
Overhead Reading Light (Overhead Console)	T1037
Overhead Reading Light (Rearview Mirror)	T192
Rear Cargo	T906
Visor Vanity	6501966

All the inside bulbs are brass or glass wedge base. Aluminum base bulbs are not approved and should not be used for replacement.

LIGHTS BULBS — Outside	Bulb No.
Low Beam Headlight	9006XS
High Beam Headlight	9005XS
Front Park/Turn Signal/Side Marker Light	4157NAKX
Front Fog Light	9145
Center High Mounted Stop Light (CHMSL) (Sedan)	921-W16W
Center High Mounted Stop Light (CHMSL) (Convertible)	LED
Rear Tail/Stop	3157
Rear Turn Signal	3757A
Backup Light	3157-P27/7W
License Light	168

BULB REPLACEMENT

Headlight Bulb Replacement

CAUTION!

Do not touch the new headlight bulb with your fingers. Oil contamination will severely shorten bulb life.

1. Remove the headlight access cover splash shield, located in the front wheel well opening.
2. Disconnect the electrical connector.

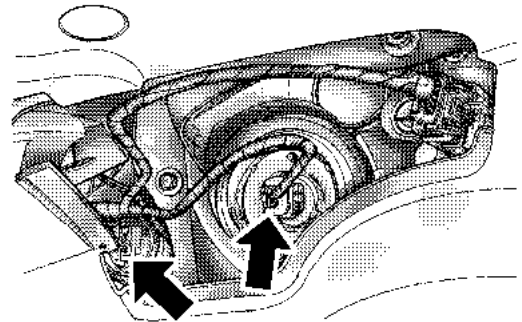

80c41468

3. Rotate the socket to the left one quarter turn and replace the bulb.

Front Park/Turn Signal/Side Marker Lights

1. Remove the headlight access cover splash shield, located in the front wheel well opening.
2. Rotate the socket to the left one quarter turn to replace and replace the bulb.

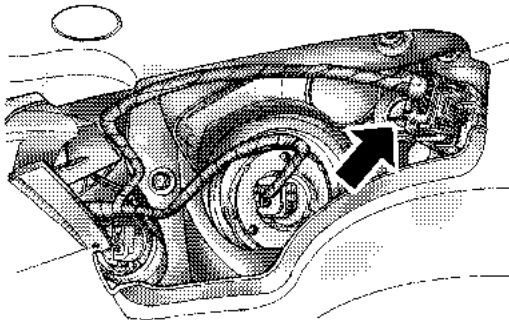

B0c1486

Front Fog Lights — If Equipped

1. Remove the fasteners attaching the lower splash shield to gain access to the fog light.
2. Twist and remove the bulb from the fog light housing.
3. Disconnect the electrical connector and replace bulb.

Tail/Stop, and Rear Turn Signal Lights

1. Remove the screw attaching the tail light housing and remove the housing from the vehicle.
2. Twist the bulb socket 1/4 turn to remove it from the housing.

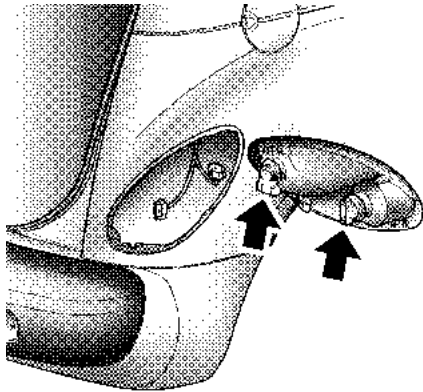

3. Pull the bulb out of the socket and replace.

Back Up Light Bulb

1. To remove the back up lamp housing from the rear fascia, carefully pry out on the outboard side of the housing.
2. Remove the socket from the housing.
3. Pull the bulb out of the socket and replace.

Center High Mounted Stop Light

1. Open the liftgate and remove the liftgate CHMSL cover.
2. Remove CHMSL lens from the housing by unlatching the two side latches.
3. Pull the bulb out of the socket and replace.

FLUIDS AND CAPACITIES

	U.S.	Metric
Fuel (Approximate)	15 Gallons	56.7 Liters
Engine Oil-With Filter		
2.4 Liter Engines (Use API Certified SAE 5W-30 Engine Oil.	5.0 qts	4.7 Liters
Cooling System *		
2.4 Liter Engines (Mopar® Antifreeze/Coolant 5 Year/100,000 Miles Formula), or equivalent.	6.5 qts	6.2 Liters
* Includes heater and coolant recovery bottle filled to MAX level.		

FLUIDS, LUBRICANTS AND GENUINE PARTS**Engine**

Component	Fluids, Lubricants and Genuine Parts
Engine Coolant	Mopar® Antifreeze/Coolant 5 Year/100,000 Mile Formula HOAT (Hybrid Organic Additive Technology) or equivalent.
Engine Oil	Use API Certified SAE 5W-30 Engine Oil. Refer to your engine oil filler cap for correct SAE grade meeting DaimlerChrysler Material Standard MS-6395.
Engine Oil Filter	Non Turbo—Mopar 4105409AB or equiv. Turbo—Mopar 4781452BB or equiv.
Spark Plugs	Refer to the Vehicle Emission Control Information label in the engine compartment.
Fuel Selection	91 Octane for High Output 2.4L Turbo and 87 Octane for 2.4L Standard Turbo and 2.4L Standard Non Turbo Engines.

Chassis

Component	Fluids, Lubricants and Genuine Parts.
Automatic Transmission Fluid.	Mopar® ATF+4 Automatic Transmission Fluid.
Manual Transmission Fluid.	Mopar® ATF+4 Automatic Transmission Fluid.
Brake Master Cylinder	Mopar® DOT 3, SAE J1703 should be used. If DOT 3, SAE J1703 brake fluid is not available, then DOT 4 is acceptable. Use only recommended brake fluids or equivalent.
Power Steering Reservoir	Mopar® Power Steering Fluid +4 or Mopar®ATF+4 Automatic Transmission Fluid.

MAINTENANCE SCHEDULES

CONTENTS

■ Emission Control System Maintenance	416	□ Schedule "A"—Non Turbo	429
■ Maintenance Schedule	416	□ Schedule "A"—Turbo	433
□ Schedule "B"—All Engines	419		

EMISSION CONTROL SYSTEM MAINTENANCE

The “Scheduled” maintenance services, listed in **bold type** must be done at the times or mileages specified to assure the continued proper functioning of the emission control system. These, and all other maintenance services included in this manual, should be done to provide best vehicle performance and reliability. More frequent maintenance may be needed for vehicles in severe operating conditions such as dusty areas and very short trip driving.

Inspection and service also should be done any time a malfunction is suspected.

NOTE: Maintenance, replacement, or repair of the emission control devices and systems on your vehicle may be performed by any automotive repair establishment or individual using any automotive part which has been certified pursuant to U.S. EPA or, in the State of California, California Air Resources Board regulations.

MAINTENANCE SCHEDULE

There are three maintenance schedules that show **required** service for your vehicle.

First is Schedule “**B**”—**ALL ENGINES**. It is for vehicles that are operated under the conditions that are listed below and at the beginning of the schedule.

- Day and night temperatures are below 32° F (0° C).
- Stop and go driving.
- Extensive engine idling.
- Driving in dusty conditions.
- Short trips of less than 10 miles (16 km).
- More than 50% of your driving is at sustained high speeds during hot weather, above 90° F (32° C).
- Trailer towing.†◇

- Taxi, police, or delivery service (commercial service).†◇
- Off-road or desert operation.
- **If equipped for and operating with E-85 (ethanol) fuel.**

NOTE: If **ANY** of these apply to you then change your engine oil every 3,000 miles (5 000 km) or 3 months, whichever comes first, and follow schedule “B—All Engines” of the “Maintenance Schedules” section of this manual.

NOTE: IF **ANY** of these apply to you then flush and replace the engine coolant every 102,000 miles (170 000 km) or 60 months, whichever comes first, and follow schedule “B—All Engines” of the “Maintenance Schedules” section of this manual.

NOTE: Most vehicles are operated under the conditions listed for Schedule “B”—ALL ENGINES.

Second is Schedule “A”—**NON TURBO**. It is for vehicles that are not operated under any of the conditions listed under Schedule “B”—ALL ENGINES.

Third is Schedule “A”—**TURBO**. It is for vehicles that are not operated under any of the conditions listed under Schedule “B”—ALL ENGINES.

Use the schedule that best describes your driving conditions. Where time and mileage are listed, follow the interval that occurs first.

CAUTION!
Failure to perform the required maintenance items may result in damage to the vehicle.

418 MAINTENANCE SCHEDULES

At Each Stop for Fuel

- Check the engine oil level about 5 minutes after a fully warmed engine is shut off. Checking the oil level while the vehicle is on level ground will improve the accuracy of the oil level reading. Add oil only when the level is at or below the ADD or MIN mark.
- Check the windshield washer solvent and add if required.

Once a Month

- Check tire pressure and look for unusual wear or damage.
- Inspect the battery and clean and tighten the terminals as required.
- Check the fluid levels of coolant reservoir, brake master cylinder and transaxle and add as needed.

- Check all lights and all other electrical items for correct operation.
- Check rubber seals on each side of the radiator for proper fit.

At Each Oil Change

- Change the engine oil filter.
- Inspect the exhaust system.
- Inspect the brake hoses.
- Inspect the CV joints and front suspension components.
- Check the automatic transaxle fluid level.
- Check the manual transaxle fluid level and fill plug condition.
- Check the coolant level, hoses, and clamps.

SCHEDULE "B"—ALL ENGINES

Follow schedule "B"—All Engines if you usually operate your vehicle under one or more of the following conditions.

Change the automatic transmission fluid and filter every 60,000 miles (100 000 km) if the vehicle is usually operated under one or more of the conditions marked with an \diamond .

Change the manual transaxle fluid every 48,000 miles (80 000 km) if the vehicle is usually operated under one or more of the conditions marked with an \dagger .

- Day and night temperatures are below 32° F (0° C).
- Stop and go driving.
- Extensive engine idling.
- Driving in dusty conditions.
- Short trips of less than 10 miles (16.2 km).

- More than 50% of your driving is at sustained high speeds during hot weather, above 90° F (32° C).
- Trailer towing. $\dagger \diamond$
- Taxi, police, or delivery service (commercial service). $\dagger \diamond$
- Off-road or desert operation.
- **If equipped for and operating with E-85 (ethanol) fuel.**

NOTE: If ANY of these apply to you then change your engine oil every 3,000 miles (5 000 km) or 3 months, whichever comes first, and follow schedule "B—All Engines" of the "Maintenance Schedules" section of this manual.

NOTE: IF ANY of these apply to you then flush and replace the engine coolant every 102,000 miles (170 000

420 SCHEDULE "B"—ALL ENGINES

km) or 60 months, whichever comes first, and follow schedule "B—All Engines" of the "Maintenance Schedules" section of this manual.

If none of these apply to you, and your vehicle is equipped with a Non-Turbo Charged Engine then change your engine oil at every interval shown on schedule "A"—NON TURBO in the maintenance schedule section of this manual.

If none of these apply to you, and your vehicle is equipped with a Turbo Charged Engine change your engine oil at every interval shown on schedule "A"—TURBO in the maintenance schedule section of this manual.

Miles (Kilometers)	3,000 (5 000)	6,000 (10 000)	9,000 (15 000)	12,000 (20 000)	15,000 (25 000)	18,000 (30 000)
Change engine oil and engine oil filter, if not replaced at 3 months.	X	X	X	X	X	X
Rotate tires.		X		X		X
Inspect the brake linings.				X		
Inspect the engine air cleaner filter , replace as necessary.*					X	
Inspect the Make-up air filter , replace as necessary.					X	

422 SCHEDULE "B"—ALL ENGINES

Miles (Kilometers)	21,000 (35 000)	24,000 (40 000)	27,000 (45 000)	30,000 (50 000)	33,000 (55 000)	36,000 (60 000)
Change engine oil and engine oil filter, if not replaced at 3 months.	X	X	X	X	X	X
Rotate tires.		X		X		X
Inspect the brake linings.		X				X
Replace the engine air cleaner filter .				X		
Replace the spark plugs .				X		
Inspect the tie rod ends and boot seals.				X		
Inspect the PCV valve and replace as necessary.*				X		
Replace the Make-up air filter .				X		
Adjust the generator drive belt tension.				X		

Miles (Kilometers)	39,000 (65 000)	42,000 (70 000)	45,000 (75 000)	48,000 (80 000)	51,000 (85 000)	54,000 (90 000)
Change engine oil and engine oil filter, if not replaced at 3 months.	X	X	X	X	X	X
Rotate tires.		X		X		X
Inspect the brake linings.				X		
Change the brake fluid. If vehicle is used for trailer towing.				X		
Inspect the engine air cleaner filter , replace as necessary.*			X			
Change the manual transaxle fluid.†				X		
Inspect the Make-up air filter . Replace as necessary.			X			

424 SCHEDULE "B"—ALL ENGINES

Miles (Kilometers)	57,000 (95 000)	60,000 (100 000)	63,000 (105 000)	66,000 (110 000)	69,000 (115 000)	72,000 (120 000)
Change engine oil and engine oil filter, if not replaced at 3 months.	X	X	X	X	X	X
Rotate tires.		X		X		X
Inspect the brake linings.		X				X
Replace the engine air cleaner filter .		X				
Replace the spark plugs and ignition cables .		X				
Inspect the tie rod ends and boot seals.		X				
Inspect the PCV valve and replace if necessary. Not required if previously changed. * ‡		X				
Replace the Make-up air filter .		X				
Adjust the generator drive belt tension.		X				
Change the automatic transaxle fluid and filter. ◇		X				
Flush and replace engine coolant at 60 months, if not done at 102,000 miles.		X				

Miles (Kilometers)	75,000 (125 000)	78,000 (130 000)	81,000 (135 000)	84,000 (140 000)	87,000 (145 000)	90,000 (150 000)
Change engine oil and engine oil filter, if not replaced at 3 months.	X	X	X	X	X	X
Rotate tires.		X		X		X
Inspect the brake linings.				X		
Inspect the engine air cleaner filter and replace as necessary.*	X					
Replace the engine air cleaner filter .						X
Replace the spark plugs .						X
Inspect the tie rod ends and boot seals.						X
Inspect the PCV valve and replace if necessary. Not required if previously changed. * ‡						X
Replace the engine timing belt . *						X
Inspect the Make-up air filter , replace as necessary.	X					
Adjust the generator drive belt tension.						X
Replace the Make-up air filter .						X

426 SCHEDULE "B"—ALL ENGINES

Miles (Kilometers)	93,000 (155 000)	96,000 (160 000)	99,000 (165 000)	102,000 (170 000)	105,000 (175 000)
Change engine oil and engine oil filter, if not replaced at 3 months.	X	X	X	X	X
Rotate tires.		X		X	
Inspect the brake linings.		X			
Change the brake fluid. If vehicle is used for trailer towing.		X			
Inspect the engine air cleaner filter and replace as necessary.*					X
Change the manual transaxle fluid.†		X			
Flush and replace the engine coolant, if not replaced at 60 months.				X	
Inspect the Make-up air filter , replace as necessary.					X

Miles (Kilometers)	108,000 (180 000)	111,000 (185 000)	114,000 (190 000)	117,000 (195 000)	120,000 (200 000)
Change engine oil and engine oil filter, if not replaced at 3 months.	X	X	X	X	X
Rotate tires.	X		X		X
Inspect the brake linings.			X		
Replace the engine air cleaner filter. *					X
Inspect the tie rod ends and boot seals.					X
Replace the Make-up air filter.					X
Adjust the generator drive belt tension.					X
Change automatic transaxle fluid and filter. ◇					X
Inspect the PCV valve and replace if necessary. *‡					X
Flush and replace the engine coolant at 120 months, if not replaced at 102,000 miles.					X
Replace the spark plugs and ignition cables.					X

428 SCHEDULE "B"—ALL ENGINES

* This maintenance is recommended by the manufacturer to the owner but is not required to maintain the emissions warranty.

‡ This maintenance is not required if previously replaced.

† This maintenance is required only for police, taxi, limousine type operation, or trailer towing.

◇ This maintenance is required only for police, taxi, limousine type operation, or trailer towing.

Inspection and service should also be performed anytime a malfunction is observed or suspected. Retain all receipts.

SCHEDULE "A"—NON TURBO

Miles (Kilometers) [Months]	6,000 (10 000) [6]	12,000 (20 000) [12]	18,000 (30 000) [18]	24,000 (40 000) [24]	30,000 (50 000) [30]	36,000 (60 000) [36]
Change engine oil and engine oil filter.	X	X	X	X	X	X
Rotate tires.	X	X	X	X	X	X
Inspect the brake linings.			X			X
Replace the engine air cleaner filter .					X	
Replace the spark plugs .					X	
Inspect the tie rod ends and boot seals.					X	
Replace the Make-up air filter .					X	
Adjust the generator drive belt tension					X	

430 SCHEDULE "A"—NON TURBO

Miles (Kilometers) [Months]	42,000 (70 000) [42]	48,000 (80 000) [48]	54,000 (90 000) [54]	60,000 (100 000) [60]	66,000 (110 000) [66]
Change engine oil and engine oil filter.	X	X	X	X	X
Rotate tires.	X	X	X	X	X
Inspect the brake linings.			X		
Replace the engine air cleaner filter .				X	
Replace the spark plugs and ignition cables .				X	
Inspect the tie rod ends and boot seals.				X	
Inspect the PCV valve and replace, if necessary.*				X	
Flush and replace the engine coolant at 60 months, if not done at 102,000 miles.				X	
Replace the Make-up air filter .				X	
Adjust the generator drive belt tension.				X	

Miles (Kilometers) [Months]	72,000 (120000) [72]	78,000 (130000) [78]	84,000 (140 000) [84]	90,000 (150 000) [90]	96,000 (160 000) [96]	102,000 (170 000) [102]
Change engine oil and engine oil filter.	X	X	X	X	X	X
Rotate tires.	X	X	X	X	X	X
Inspect the brake linings.	X			X		
Replace the engine air cleaner filter .				X		
Replace the spark plugs .				X		
Inspect the tie rod ends and boot seals.				X		
Inspect the PCV valve and replace if necessary. Not required if previously changed. * ‡				X		
Replace the Make-up air filter .				X		
Adjust the generator drive belt tension.				X		
Flush and replace the engine coolant, if not replaced at 60 months.						X

432 SCHEDULE "A"—NON TURBO

Miles (Kilometers) [Months]	108,000 (180 000) [108]	114,000 (190 000) [114]	120,000 (200 000) [120]
Change engine oil and engine oil filter.	X	X	X
Rotate tires.	X	X	X
Inspect the PCV valve and replace if necessary. * ‡			X
Replace the air cleaner filter .			X
Replace the engine timing belt . *			X
Flush and replace the engine coolant at 120 months, if not done at 102,000 miles.			X
Replace the spark plugs and ignition cables .			X
Replace the Make-up air filter .			X

* This maintenance is recommended by the manufacturer to the owner but is not required to maintain the emissions warranty.

Inspection and service should also be performed anytime a malfunction is observed or suspected. Retain all receipts.

‡ This maintenance is not required if previously replaced.

SCHEDULE "A"—TURBO

Miles (Kilometers)	5,000 (8 000)	10,000 (16 000)	15,000 (24 000)	20,000 (32 000)	25,000 (40 000)	30,000 (48 000)
[Months]	[6]	[12]	[18]	[24]	[30]	[36]
Change engine oil and engine oil filter.	X	X	X	X	X	X
Rotate tires.	X	X	X	X	X	X
Inspect the brake linings.				X		
Replace the engine air cleaner filter .						X
Replace the spark plugs .						X
Inspect the tie rod ends and boot seals.						X
Replace the Make-up air filter .						X
Adjust the generator drive belt tension.						X

434 SCHEDULE "A"—TURBO

Miles (Kilometers) [Months]	35,000 (56 000) [42]	40,000 (64 000) [48]	45,000 (72 000) [54]	50,000 (80 000) [60]	55,000 (88 000) [66]
Change engine oil and engine oil filter.	X	X	X	X	X
Rotate tires.	X	X	X	X	X
Inspect the brake linings.		X			
Flush and replace engine coolant at 60 months, if not replaced at 100,000 miles.				X	

Miles (Kilometers)	60,000 (96 000)	65,000 (104 000)	70,000 (112 000)	75,000 (120 000)	80,000 (128 000)	85,000 (136 000)
[Months]	[72]	[78]	[84]	[90]	[96]	[102]
Change engine oil and engine oil filter.	X	X	X	X	X	X
Rotate tires.	X	X	X	X	X	X
Inspect the brake linings.	X				X	
Replace the engine air cleaner filter .	X					
Replace the spark plugs and ignition cables .	X					
Inspect the tie rod ends and boot seals.	X					
Inspect the PCV valve and replace if necessary. Not required if previously changed. * ‡	X					
Replace the Make-up air filter .	X					
Adjust the generator drive belt tension.	X					

436 SCHEDULE "A"—TURBO

Miles (Kilometers) [Months]	90,000 (144 000) [108]	95,000 (156 000) [114]	100,000 (160 000) [120]	105,000 (168 000) [126]
Change engine oil and engine oil filter.	X	X	X	X
Rotate tires.	X	X	X	X
Inspect the brake linings.			X	
Replace the engine air cleaner filter .	X			
Replace the spark plugs .	X			
Adjust the generator drive belt tension.	X			
Inspect the tie rod ends and boot seals.	X			
Inspect the PCV valve and replace if necessary. Not required if previously changed. * ‡	X			
Flush and replace the engine coolant if not done at 60 months.			X	
Replace the Make-up air filter .	X			
Replace the engine timing belt .				X

Miles (Kilometers) [Month]	110,000 (177 000) [132]	115,000 (185 000) [138]	120,000 (193 000) [144]
Change engine oil and engine oil filter.	X	X	X
Rotate tires.	X	X	X
Inspect the PCV Valve and replace if necessary. *			X
Replace the engine air cleaner filter .			X
Replace the spark plugs and ignition cables .			X

* This maintenance is recommended by the manufacturer to the owner but is not required to maintain the emissions warranty.

‡ This maintenance is not required if previously replaced.

Inspection and service should also be performed anytime a malfunction is observed or suspected. Retain all receipts.

WARNING!
You can be badly injured working on or around a motor vehicle. Do only that service work for which you have the knowledge and the right equipment. If you have any doubt about your ability to perform a service job, take your vehicle to a competent mechanic.

IF YOU NEED CONSUMER ASSISTANCE

CONTENTS

■ Suggestions For Obtaining Service For Your Vehicle	440	■ Reporting Safety Defects	443
□ Prepare For The Appointment	440	□ In Canada	443
□ Prepare A List	440	■ Publication Order Forms	444
□ Be Reasonable With Requests	440	■ Department Of Transportation Uniform Tire Quality Grades	445
■ If You Need Assistance	440	□ Treadwear	445
■ Warranty Information (U.S. Vehicles Only)	443	□ Traction Grades	445
■ Mopar® Parts	443	□ Temperature Grades	446

SUGGESTIONS FOR OBTAINING SERVICE FOR YOUR VEHICLE**Prepare For The Appointment**

If you're having warranty work done, be sure to have the right papers with you. Take your warranty folder. All work to be performed may not be covered by the warranty, discuss additional charges with the service manager. Keep a maintenance log of your vehicle's service history. This can often provide a clue to the current problem.

Prepare A List

Make a written list of your vehicle's problems or the specific work you want done. If you've had an accident, or work done that is not on your maintenance log, let the service advisor know.

Be Reasonable With Requests

If you list a number of items, and you must have your vehicle by the end of the day, discuss the situation with the service advisor and list the items in order of priority. At many dealers you may obtain a rental vehicle at a minimal daily charge. If you need a rental, it is advisable to make these arrangements when you call for an appointment.

IF YOU NEED ASSISTANCE

The manufacturer and its dealers are vitally interested in your satisfaction. We want you to be happy with our products and services.

Warranty service must be done by an authorized Chrysler, Dodge, or Jeep dealer. We strongly recommend that you take your vehicle to your selling dealer. They know you and your vehicle best, and are most concerned that you get prompt and high quality service. The manufacturer's dealers have the facilities, factory-trained

technicians, special tools, and the latest information to assure your vehicle is fixed correctly and in a timely manner.

This is why you should always talk to your dealer's service manager first. Most matters can be resolved with this process.

- If for some reason you are still not satisfied, talk to the general manager or owner of the dealership. They want to know if you need assistance.
- If your dealership is unable to resolve the concern, you may contact the Manufacturer's Customer Center.

Any communication to the Manufacturer's Customer Center should include the following information:

- Owner's name and address
- Owner's telephone number (home and office)
- Dealership name

- Vehicle identification number
- Vehicle delivery date and mileage

DaimlerChrysler Motors Corporation Customer Center

P.O. Box 21-8004
 Auburn Hills, MI 48321-8004
 Phone: (800) 992-1997

DaimlerChrysler Canada Inc. Customer Center

P.O. Box 1621
 Windsor, Ontario N9A 4H6
 Phone —(800) 465-2001

In Mexico contact:

Av. Prolongacion Paseo de la Reforma, 1240
 Sante Fe C.P. 05109
 Mexico, D. F.
 In Mexico (915) 729-1248 or 729-1240
 Outside Mexico (525) 729-1248 or 729-1240

Customer Assistance For The Hearing Or Speech Impaired (TDD/TTY)

To assist customers who have hearing difficulties, the manufacturer has installed special TDD (Telecommunication Devices for the Deaf) equipment at its Customer Center. Any hearing or speech impaired customer who has access to a TDD or a conventional teletypewriter (TTY) in the United States can communicate with the manufacturer by dialing 1-800-380-CHRY.

Service Contract

You may have purchased a service contract for your vehicle to help protect you from the high cost of unexpected repairs after your manufacturer's new vehicle limited warranty expires. The manufacturer stands behind only the manufacturer's Service Contracts. If you purchased a manufacturer's Service Contract, you will receive Plan Provisions and an Owner Identification Card in the mail within three weeks of your vehicle delivery date. If you have any questions about your service

contract, call the manufacturer's Service Contract National Customer Hotline at 1-800-521-9922.

The manufacturer will not stand behind any service contract that is not the manufacturer's Service Contract. It is not responsible for any service contract other than the manufacturer's Service Contract. If you purchased a service contract that is not a manufacturer's Service Contract, and you require service after your manufacturer's new vehicle limited warranty expires, please refer to your contract documents, and contact the person listed in those documents.

We appreciate that you have made a major investment when you purchased your new vehicle. Your dealer has also made a major investment in facilities, tools, and training to assure that you are absolutely delighted with your ownership experience. You'll be pleased with their sincere efforts to resolve any warranty issues or related concerns.

WARRANTY INFORMATION (U.S. Vehicles Only)

See the Warranty Information Booklet for the terms and provisions of DaimlerChrysler's warranties applicable to this vehicle.

MOPAR® PARTS

Mopar® fluids, lubricants, parts, and accessories are available from your dealer. They will help you keep your vehicle operating at its best.

REPORTING SAFETY DEFECTS

In the 50 United States and Washington D.C.: If you believe that your vehicle has a defect which could cause a crash or cause injury or death, you should immediately inform the National Highway Traffic Safety Administration (NHTSA) in addition to notifying the manufacturer.

If NHTSA receives similar complaints, it may open an investigation, and if it finds that a safety defect exists in a group of vehicles, it may order a recall and remedy

campaign. However, NHTSA cannot become involved in individual problems between you, your dealer, and the manufacturer.

To contact NHTSA, you may either call the Auto Safety Hotline toll free at 1-888-327-4236 (TTY: 1-800-424-9153), or go to <http://www.NHTSA.gov>. or write to: NHTSA, U.S. Dept. of Transportation, Washington DC 20590. You can also obtain other information about motor vehicle safety from the Hotline.

In Canada:

If you believe that your vehicle has a safety defect, you should contact the Customer Service Department immediately. Canadian customers who wish to report a safety defect to the Canadian government should write to Transport Canada, Motor Vehicle Defect Investigations and Recalls, 2780 Sheffield Road, Ottawa, Ontario K1B 3V9.

PUBLICATION ORDER FORMS

To order the following manuals, you may use either the website or the phone numbers listed below. Visa, Mastercard, American Express, and Discover orders are accepted. If you prefer mailing your payment, please call for an order form.

NOTE: A street address is required when ordering manuals. (No P.O. Boxes).

- *Service Manuals.*

These comprehensive service manuals provide the information that students and professional technicians need in diagnosing/troubleshooting, problem solving, maintaining, servicing and repairing DaimlerChrysler Corporation vehicles. A complete working knowledge of the vehicle, system and/or components is written in straightforward language with illustrations, diagrams and charts.

- *Diagnostic Procedure Manuals.*

Filled with diagrams, charts and detailed illustrations, these practical manuals make it easy for students and technicians to find and fix problems on computer-controlled vehicle systems and features. They show exactly how to find and correct problems the first time, using step-by-step troubleshooting and driveability procedures, proven diagnostic tests and a complete list of all tools and equipment.

- *Owner's Manuals.*

These manuals have been prepared with the assistance of service and engineering specialists to acquaint you with specific Chrysler group vehicles. Included are starting, operating, emergency and maintenance procedures as well as specifications, capabilities and safety tips.

Call Toll Free at:

- 1-800-890-4038 (U.S.)
- 1-800-387-1143 (Canada)

Or

Visit us on the World Wide Web at:

- www.techauthority.daimlerchrysler.com
- www.daimlerchrysler.ca/manuals

DEPARTMENT OF TRANSPORTATION UNIFORM TIRE QUALITY GRADES

The following describes the tire grading categories established by the National Highway Traffic Safety Administration. The specific grade rating assigned by the tire's manufacturer in each category is shown on the sidewall of the tires on your car.

All Passenger Car Tires Must Conform to Federal Safety Requirements in Addition to These Grades.

Treadwear

The treadwear grade is a comparative rating based on the wear rate of the tire when tested under controlled conditions on a specified government test course. For example, a tire graded 150 would wear one and a half (1 1/2) times as well on the government course as a tire graded 100. The relative performance of tires depends upon the actual conditions of their use, however, and may depart significantly from the norm due to variations in driving habits, service practices and differences in road characteristics and climate.

Traction Grades

The traction grades, from highest to lowest, are AA, A, B, and C. Those grades represent the tire's ability to stop on wet pavement as measured under controlled conditions

on specified government test surfaces of asphalt and concrete. A tire marked C may have poor traction performance.

WARNING!

The traction grade assigned to this tire is based on straight-ahead braking traction tests, and does not include acceleration, cornering, hydroplaning, or peak traction characteristics.

Temperature Grades

The temperature grades are A (the highest), B, and C, representing the tire's resistance to the generation of heat and its ability to dissipate heat when tested under controlled conditions on a specified indoor laboratory test wheel. Sustained high temperature can cause the material of the tire to degenerate and reduce tire life, and excessive temperature can lead to sudden tire failure. The

grade C corresponds to a level of performance which all passenger car tires must meet under the Federal Motor Vehicle Safety Standard No. 109. Grades B and A represent higher levels of performance on the laboratory test wheel than the minimum required by law.

WARNING!

The temperature grade for this tire is established for a tire that is properly inflated and not overloaded. Excessive speed, underinflation, or excessive loading, either separately or in combination, can cause heat buildup and possible tire failure.

INDEX

ABS (Anti-Lock Brake System)	297	Alignment and Balance	319
Adding Engine Coolant (Antifreeze)	384	Alterations/Modifications, Vehicle	7
Adding Fuel	326	Antenna, Satellite Radio	265
Adding Washer Fluid	187,275	Antifreeze (Engine Coolant)	383,411,412
Additives, Fuel	324	Capacities	411
Air Cleaner, Engine (Engine Air Cleaner Filter)	374	Disposal	385
Air Conditioner Maintenance	377	Anti-Lock Brake System (ABS)	297
Air Conditioning Controls	266	Anti-Lock Warning Light	227
Air Conditioning, Operating Tips	271	Anti-Theft Security Alarm (Theft Alarm)	36
Air Conditioning Refrigerant	377,378	Appearance Care	395
Air Conditioning System	266,377	Auto Down Power Windows	43
Air Pressure, Tires	312	Automatic Door Locks	20,21
Airbag	55,89	Automatic Transaxle	13,280,284,391
Airbag Deployment	68,101	Fluid and Filter Changes	393
Airbag Light	70,103,115,227	Fluid Level Check	392
Airbag Maintenance	69,103	Interlock System	18,285
Airbag, Side	65,99	Reset Mode	285
Alarm, Panic	33	Selection Of Lubricant	391
Alarm System (Security Alarm)	36,226	Shifting	286

Special Additives	394	Warning Light	225
Autostick	289	Brakes	296,388
Back-Up Lights	410	Brake/Transmission Interlock	285
Ball Joints	378	Break-In Recommendations, New Vehicle	113
Battery	375	Bulb Replacement	407,408
Keyless Transmitter Replacement (RKE)	30,35	Bulbs, Light	407
Belts, Drive	372	Calibration, Compass	237
Belts, Engine	374	Capacities, Antifreeze (Engine Coolant)	411
Body Mechanism Lubrication	379	Capacities, Fluid	411
Boot, Convertible Top	126,130	Caps, Filler	
B-Pillar Location	307	Fuel	326
Brake Fluid	413	Oil (Engine)	362,363,370
Brake, Parking	294	Car Washes	395
Brake System	296,388	Carbon Monoxide Warning	325
Anti-Lock (ABS)	297	Cargo Compartment	
Hoses	388	Luggage Carrier	212
Master Cylinder	389	Carrier, Luggage	212
Parking	294	Catalytic Converter	372

Caution, Exhaust Gas	114	Coin Holder	204
CD (Compact Disc) Player	240,248	Compact Disc (CD) Maintenance	265
CD (Compact Disc) Player Maintenance	265	Compact Spare Tire	315
Cellular Phone	136,266	Compass	237
Center High Mounted Stop Light	410	Compass Calibration	237
Chains, Tire	320	Compass Variance	235
Changing A Flat Tire	346	Console	204
Chart, Tire Sizing	304	Contract, Service	442
Check Engine Light (Malfunction Indicator Light)	365	Convertible	121
Child Restraint	72,105	Convertible Boot	126,130
Child Restraint Tether Anchors	76,109	Convertible Top	121
Child Restraint with Automatic Belts	75	Convertible Top Maintenance	400
Child Safety Locks	23	Convertible Top Manual Override	132,357
Child Seat	78,111	Cool Down, Turbo	282
Clean Air Gasoline	323	Coolant (Antifreeze)	411,412
Climate Control	266	Cooling System	382
Clock	238,242,250	Adding Coolant (Antifreeze)	384
Clutch	389	Coolant Level	382,385
Clutch Fluid	389	Disposal of Used Coolant	385

Drain, Flush, and Refill	383	Diagnostic System, Onboard	364
Inspection	385	Dimmer Switch, Headlight	183
Points to Remember	384,386	Disposal	
Pressure Cap	384	Antifreeze (Engine Coolant)	385
Selection of Coolant (Antifreeze)	383	Engine Oil	371
Corrosion Protection	395	Door Locks	18
Crankcase Emission Control System	374	Door Locks, Automatic	20
Cruise Light	223	Door Opener, Garage	192
Cup Holder	204	Downshifting	293
Customer Assistance	440	Drive Belts	372
		Driver's Seat Back Tilt	163
Data Recorder, Event	70,103	Driving	
Dealer Service	367	On Slippery Surfaces	353
Deck Lid (Convertible)	39	Electric Rear Window Defrost	273
Deck Lid, Emergency Release Latch (Convertible)	41	Electric Remote Mirrors	135
Deck Lid, Power Release	40	Electrical Power Outlets	201
Defroster, Rear Window	273	Electronic Speed Control (Cruise Control)	189
Defroster, Windshield	115,268	Electronic Vehicle Information Center (EVIC)	229
Delay (Intermittent) Wipers	185		

Emergency Deck Lid Release Latch (Convertible) . . .	41	Oil Synthetic	371
Emergency, In Case of		Overheating	344
Jacking	346	Temperature Gauge	222
Jump Starting	351	Timing Belt	374
Towing	355	Event Data Recorder	70,103
Emergency Seat Back Release (Sedan)	40	Exhaust Gas Caution	39,114,325,381
Emission Control System Maintenance	365,416	Exhaust System	381
Engine	362,363	Filler Location Fuel	222
Break-In Recommendations	113	Filters	
Checking Oil Level	368	Air Cleaner	374
Cooling	382	Engine Fuel	374
Exhaust Gas Caution	325	Engine Oil	371,412
Fuel Requirements	322	Flashers	344
Jump Starting	351	Hazard Warning	344
Oil	368,411,412	Flat Tire Stowage	351
Oil Change Interval	369	Flooded Engine Starting	281
Oil Filler Cap	362,363,370	Fluid, Brake	413
Oil Filter	412	Fluid Capacities	411
Oil Selection	370		

Fluid Leaks	115	Filter	374
Fluid Level Checks		Gasoline	322
Automatic Transaxle	392	Gauge	222
Fluids	412	Hoses	387
Fluids, Lubricants and Genuine Parts	412	Light	227
Fog Light Service	409	Octane Rating	322
Fog Lights	183,227	Requirements	322
Folding Front Passenger Seat	162	System Hoses	387
Folding Rear Seat	166,168	Tank Capacity	411
Folding Rear Seat (Convertible)	168	Fuel System Caution	329
Folding Rear Seat (Sedan)	166	Fueling	326
Freeing A Stuck Vehicle	354	Fuses	403
Fuel	322,412	Garage Door Opener (HomeLink®)	192
Adding	326	Gas Cap (Fuel Filler Cap)	326,328,364
Additives	324	Gasoline, Clean Air	323
Capacity	411	Gasoline (Fuel)	322,411
Clean Air	323	Gasoline, Reformulated	323
Filler Cap (Gas Cap)	222,326		
Filler Door (Gas Cap)	222		

Gauges		
Coolant Temperature	222	
Fuel	222	
Odometer	223	
Tachometer	223	
Gearshift	286	
General Information	17	
General Maintenance	367	
Glass Cleaning	399	
Gross Axle Weight Rating	330	
Gross Vehicle Weight Rating	330	
Hands-Free Phone (UConnect™)	136	
Hazard Warning Flasher	344	
Head Restraints	164	
Headlights		
Bulb Replacement	408	
Cleaning	399	
High Beam	183,228	
High Beam/Low Beam Select Switch	183	
Passing	183	
Switch	182	
Heated Seats	165	
Hitches		
Trailer Towing	332	
HomeLink® (Garage Door Opener) Transmitter	192	
Hood Release	177	
Hoses	387	
Ignition	13	
Key	13	
Wiring System	372	
Ignition Key Removal	13	
Immobilizer (Sentry Key)	15,37	
Infant Restraint	72,106	
Information Center, Vehicle	229	
Inside Rearview Mirror	133	
Instrument Cluster	219,222	

Instrument Panel and Controls	218	Keyless Entry System (Sedan)	24
Instrument Panel Cover	399	Keys	13
Instrument Panel Lens Cleaning	400	Lane Change and Turn Signals	224
Integrated Power Module	403	Lap/Shoulder Belts	45,81
Interior Appearance Care	398	Latches	
Interior Lights	180	Hood	177
Intermittent Wipers (Delay Wipers)	185	Lead Free Gasoline	322
Introduction	4	Life of Tires	318
Jack Location	347	Liftgate (Sedan)	38
Jack Operation	346,349	Liftgate Window Wiper/Washer	186
Jacking Instructions	349	Light Bulbs	407,408
Jump Starting	351	Lights	115,178
Key, Programming	17	Airbag	70,103,115,227
Key, Replacement	16	Anti-Lock	227
Key, Sentry (Immobilizer)	15	Back-Up	410
Key-In Reminder	15	Brake Warning	225
Keyless Entry System (Convertible)	31	Center Mounted Stop	410
		Daytime Running	182

Dimmer Switch, Headlight	181	Traction Control	301
Engine Temperature Warning	226	Turn Signal	181,183,224,409
Fog	183,227,409	Voltage	226
Front Replacement	408	Warning (Instrument Cluster Description)	222
Headlight Switch	182	Loading Vehicle	329
Headlights	182	Tires	307
High Beam Indicator	228	Locks	
Instrument Cluster	182	Child Protection	23
Interior	180	Door	18
Lights On Reminder	182	Power Door	20
Low Fuel	227	Steering Wheel	18
Malfunction Indicator (Check Engine)	224	Lubrication, Body	379
Map Reading	178,179	Luggage Rack (Roof Rack)	212
Oil Pressure	227	Lumbar Support	162
Rear Servicing	410	Maintenance Free Battery	375
Seat Belt Reminder	226	Maintenance, General	367
Security Alarm (Theft Alarm)	36	Maintenance Procedures	367
Service	408		
Theft Alarm (Security Alarm)	226		

Maintenance Schedule	
Schedule "A"-Non Turbo	429
Schedule "A"-Turbo	433
Schedule "B"	419
Schedule "B"-All Engines	419
Maintenance Schedules	416
Malfunction Indicator Light (Check Engine)	224,365
Manual Override, Convertible Top	132,357
Manual, Service	444
Manual Transaxle	280,290,394
Downshifting	293
Fluid Level Check	394
Frequency of Fluid Change	394
Lubricant Selection	394
Map/Reading Lights	178,179
Master Cylinder (Brakes)	389
Mirrors	133
Electric Remote	135
Outside	134
Rearview	133
Vanity	135
Modifications/Alterations, Vehicle	7
Mopar Parts	366,443
Multi-Function Control Lever	181
New Vehicle Break-In Period	113
Occupant Classification System (OCS)	61
Occupant Restraints (Convertible)	80
Occupant Restraints (Sedan)	44
Octane Rating, Gasoline (Fuel)	322
Odometer	223
Trip	223,228
Oil, Engine	368,411
Capacity	411
Change Interval	369
Checking	368
Disposal	371

Filter	371	Parking Brake	294
Identification Logo	370	Passenger Seat Back Tilt (Easy Entry System)	163
Materials Added to	371	Passing Light	183
Quality	370	Personal Settings	232
Recommendation	370,411	Pets	79,113
Synthetic	371	Phone, Cellular	136
Viscosity	370	Phone, Hands-Free (UConnect™)	136
Oil Pressure Light	227	Placard, Tire and Loading Information	307
Onboard Diagnostic System	364,365	Power	
Opener, Garage Door (HomeLink®)	192	Deck Lid Release	40
Operator Manual (Owner's Manual)	4	Distribution Center	403
Outside Air Intake	272	Door Locks	20
Overdrive	288	Outlet (Auxiliary Electrical Outlet)	201
Overheating, Engine	344	Seats	160
Owner's Manual (Operator Manual)	4,444	Steering	299,378
		Steering, Checking	378
Paint Care	395	Sunroof	199
Panel Rear Shelf	207	Windows	42
Panic Alarm	26,33	Power Steering Fluid	413

Pregnant Women and Seat Belts	55,89	Rear Window Features	273
Preparation for Jacking	348	Rear Wiper/Washer	186,274
Pretensioners		Recorder, Event Data	70,103
Seat Belts	53,87	Recreational Towing	340
Programmable Electronic Features	194,198,232	Refrigerant	378
Programming Transmitters		Reminder, Seat Belt	54,88
(Remote Keyless Entry)	27,34,194,198	Remote Keyless Entry (Convertible)	31
Radial Ply Tires	314	Remote Keyless Entry (Sedan)	24
Radio Broadcast Signals	239	Replacement Bulbs	407
Radio Operation	240,248,266	Replacement Keys	16
Radio, Satellite	261	Replacement Parts	366
Radio (Sound Systems)	240,248	Replacement Tires	318
Rear Liftgate (Sedan)	38	Reporting Safety Defects	443
Rear Seat, Folding	166,168,169,171	Restraints, Child	72,78,105,111
Rear Seat Removal	175	Restraints, Infant	72,106
Rear Shelf Panel	207	Roof Rack (Luggage Rack)	212
Rear Window	44	Rotation, Tires	321
Rear Window Defroster	273	Safety Checks Inside Vehicle	114

Safety Checks Outside Vehicle	115	Seat Belts (Convertible)	80
Safety Defects, Reporting	443	Seat Belts (Sedan)	44
Safety Information, Tire	302	Seats	159
Safety Tips	114	Adjustment	159
Satellite Radio	261	Easy Entry	163
Satellite Radio Antenna	265	Emergency Seat Back Release (Sedan)	40
Schedule, Maintenance	416	Folding Front Passenger	162
Seat Belt Maintenance	400	Head Restraints	164
Seat Belt Reminder	54,88	Heated	165
Seat Belts		Lumbar Support	162
Adjustable Shoulder Belt	51	Power	160
Adjustable Upper Shoulder Anchorage	51	Rear Folding	166,168,169,171
And Pregnant Women	55,89	Rear Folding (Convertible)	168
Child Restraint	72,105	Rear Folding (Sedan)	166
Front Seat	45,81	Removal	175
Pretensioners	53,87	Seatback Release	163
Rear Seat	45,81	Tilting	163
Reminder	226	Tumbling Rear (Convertible)	171
Untwisting Procedure	52,86	Tumbling Rear (Sedan)	169

Security Alarm (Theft Alarm)	36	Speedometer	222
Sentry Key (Immobilizer)	15,37	Speedometer and Odometer	219
Sentry Key Programming	17	Starting	280
Service and Maintenance	416	Automatic Transmission	280
Service Assistance	440	Engine Fails to Start	281
Service Contract	442	Manual Transmission	280
Service Manuals	444	Starting Procedures	280
Setting the Clock	238,242,250	Steering	
Settings, Personal	232	Power	299,378
Severe Service	419	Tilt Column	187
Shift Speeds, Manual Transaxle	292	Wheel Lock	18
Shoulder Belts	45,81	Storage	205,406
Side Airbag	65,99	Stuck, Freeing	354
Side Window Demisters (Defrosters)	272	Sun Roof	199
Slippery Surfaces, Driving On	353	Sun Visor Extension	136
Snow Tires	320	Supplemental Restraint System - Airbag	55,89
Spare Tire	315,316,347	Synthetic Engine Oil	371
Spark Plugs	372	Tachometer	223
Speed Control (Cruise Control)	189,223		

Temperature Gauge, Engine Coolant	222,345	Inflation Pressures	312
Tether Anchor, Child Restraint	76,109	Jacking	346
Theft Alarm (Security Alarm)	36	Life of Tires	318
Theft System (Security Alarm)	36	Load Capacity	307,308
Tilt Steering Column	187	Quality Grading	445
Tire and Loading Information Placard	307	Radial	314
Tire Identification Number (TIN)	306	Replacement	318
Tire Markings	302	Rotation	321
Tire Safety Information	302	Safety	302,311
Tires	115,311,445	Sizes	304
Aging (Life of Tires)	318	Snow Tires	320
Air Pressure	311	Spare Tire	347
Alignment	319	Spinning	316
Chains	320	Tread Wear Indicators	317
Changing	346	Tongue Weight/Trailer Weight	333
Compact Spare	315	Top Cover	126
Flat Changing	351	Towing	329
General Information	311	Disabled Vehicle	355
High Speed	313	Guide	332

Recreational	340	Selection of Lubricant	391
Weight	332	Transmission	
Traction	354	Range Indicator	223
Traction Control	188,300	Transmitter Battery Service	
Traction Control Switch	188,300	(Remote Keyless Entry)	30,35
Trailer Towing	329	Transmitter, Garage Door Opener (HomeLink®) . . .	192
Cooling System Tips	340	Transmitter Programming	
Hitches	332	(Remote Keyless Entry)	27,34
Minimum Requirements	334	Transporting Pets	79,113
Trailer and Tongue Weight	333	Tread Wear Indicators	317
Wiring	338	Trip Odometer	223
Trailer Towing Guide	332	Trip Odometer Reset Button	228
Trailer Weight	332	Trunk Lid, Deck Lid (Convertible)	39
Transaxle	284	Tumbling Rear Seat (Convertible)	171
Automatic	13,280,284,391	Tumbling Rear Seat (Sedan)	169
Autostick	289	Turbo Cool Down	282
Manual	14,280,290	Turn Signals	183,224
Operation	284		
Overdrive	288	Understanding Your Instrument Panel	218

Uniform Tire Quality Grades	445	Warranty Information	443
Universal Transmitter	192	Washer, Adding Fluid	187,275
Unleaded Gasoline	322	Washer, Rear	274
Untwisting Procedure, Seat Belt	52,86	Washers, Windshield	184
		Washing Vehicle	395
Vacuum/Vapor Harnesses	387	Wheel Alignment and Balance	319
Vanity Mirrors	135	Wheel and Wheel Trim	396
Variance, Compass	235	Wheel and Wheel Trim Care	397
Vehicle Identification Number (VIN)	6	Wind Buffeting	44,201
Vehicle Loading	308,329	Window Fogging	272
Vehicle Modifications/Alterations	7	Windows	42
Vehicle Storage	406	Windshield Washers	184
Vehicle Theft Alarm (Security Alarm)	36	Windshield Wipers	184,379
		Wiper Blade Replacement	379
Warning Lights (Instrument Cluster Description)	222	Wiper, Rear	274
Warnings and Cautions	6	Wipers, Intermittent	185